

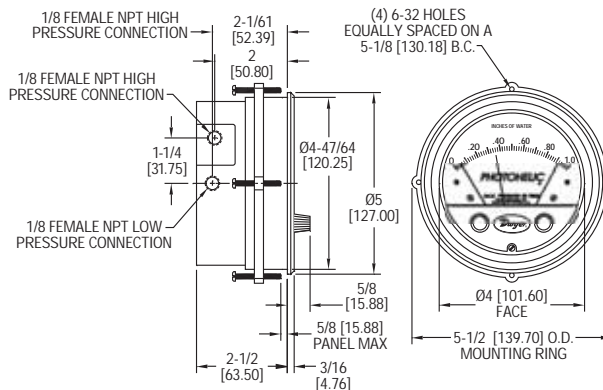

Series 3000MR Photohelic® Differential Pressure Switch/Gage

Specifications — Installation and Operating Instructions



Using solid state technology, the Series 3000MR Photohelic® switch/gage combines the functions of a precise, highly repeatable differential pressure switch with a large easy-to-read analog pressure gage employing the durable, time-proven Magnehelic® gage design. Switch setting is easy to adjust with large external knobs on the gage face. Gage reading is unaffected by switch operation — will indicate accurately even if power is interrupted. Solid state design now results in greatly reduced size and weight. Units can be flush mounted in 4 1/8" (122 mm) hole or surface mounted with hardware supplied. 3000MR models employ versatile electromechanical relays with gold over silver contacts — ideal for dry circuits. All models provide both low and high limit control and include 18-inch (45 cm) cable assemblies for electrical connections.

Gage accuracy is ±2% of full scale and switch repeatability is ±1%. Switch deadband is one pointer width — less than 1% of full scale. Compatible with air and other non-combustible, non-corrosive gases, they can be used in systems with pressures to 25 psig (1.725 bar). Optional construction is available for use to either 35 psig (2.42 bar) or 80 psig (5.51 bar).

Accessories

- Mounting ring, snap ring (4) 6-32 x 1 1/4" RH machine screws (panel mounting)
- 18" (45 cm) cable assembly (2) 3/8" tubing to 1/8" NPT adapters (3) 6-32 x 5/16" RH machine screws (surface mounting)
- (2) 1/8" NPT pipe plugs

SPECIFICATIONS

GAGE SPECIFICATIONS

- Service:** Air and non-combustible, compatible gases.
- Wetted Materials:** Consult Factory.
- Accuracy:** ±2% of full scale (3000-0 ±3% of full scale).
- Pressure Limit:** -20" Hg. to 25 psig (-0.677 bar to 1.72 bar). MP option: 35 psig (2.41 bar), HP option; 80 psig (5.52 bar).
- Temperature Limits:** 20 to 120°F. (-6.67 to 48.9°C).
- Process Connections:** 1/8 female NPT (duplicated side and back).
- Size:** 4" (101.6 mm) dial face, 5" (127mm) O.D. x 3-1/8" (79.38 mm).
- Weight:** 1.8 lb., (816 g).

SWITCH SPECIFICATIONS 3000MR

- Switch Type:** Each setpoint has 1 Form C relay (SPDT).
- Relay Contacts:** (resistive load) 1 Form C rated 1.0 amp @ 30 VDC, 0.3 amp @ 110 VDC or 0.5 amp @ 125 VAC. Gold over clad silver - suitable for dry circuits.
- Electrical Connections:** 18" (46 cm) cable assembly with 8 conductors. Optional lengths to 100' (30.5 m).
- Power Requirements:** 24 VDC, regulated ± 10%.
- Mounting Orientation:** Diaphragm in vertical position. Consult factory for other position orientations.
- Set Point Adjustment:** Adjustable knobs on face.

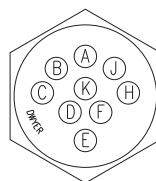

		LETTER	COLOR
Power Supply	+	A	Red
	-	E	Black
Low Set Point	COM	C	Brown
	NC	B	Violet
	NO	D	Blue
High Set Point	COM	H	Green
	NC	J	White
	NO	F	Orange

ELECTRICAL CONNECTIONS

CAUTION: Do not exceed specified electrical ratings. Permanent damage not covered by warranty will result. This unit is not designed for AC line voltage operation.

Electrical connections are made by means of the cable assembly supplied which has a multi-pin female plug installed on one end which mates with the male connector on the rear of the gage. Wire leads on the opposite end of the assembly are connected in accordance with the drawing and chart to the right.

Note: An R/C (resistor/capacitor) snubber is required when switching inductive loads such as a solenoid or contactor. specify Dwyer Instruments, Inc. part number A-600. For DC circuits, also include a 1N4005 diode.

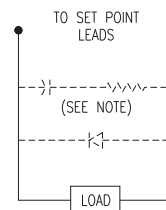

INSTALLATION

- 1. LOCATION:** Select a location where the temperature of the unit will be between 20°F and 120°F (-6.67 to 48.9°C). The tubing feeding pressure to the instrument can be run practically any length required but long lengths will increase response time slightly. Avoid surfaces with excessive vibration.
- 2. POSITION:** All standard models are calibrated with the diaphragm vertical and should be used in that position for maximum accuracy. If your application requires mounting in other than a vertical position, be sure to specify this when ordering.
- 3. PRESSURE CONNECTIONS:** For convenience, two sets of 1/8" female NPT ports are available. Plug the unused set with pipe plugs provided. Attach tubing from positive pressure source to port marked "HI" or from negative (Vacuum) source to port marked "LOW". In either case, opposite port must be vented to atmosphere. In dusty environments, we recommend use of an A-331 Filter Vent Plug to keep interior of instrument clean. For differential pressures the higher source is connected to the "HI" port and lower to the "LOW" port.

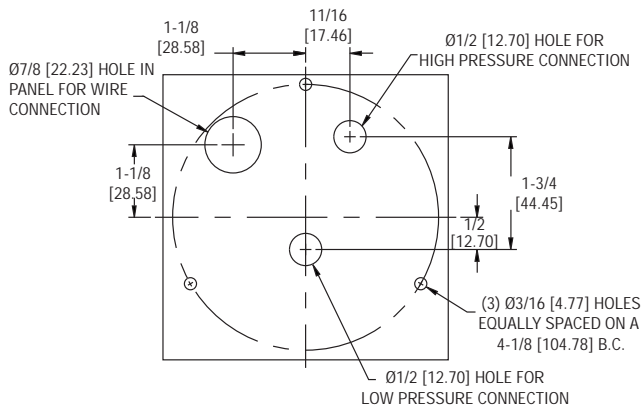

- 4. MOUNTING:** The Photohelic® Switch/Gage may be either panel mounted or surface mounted.

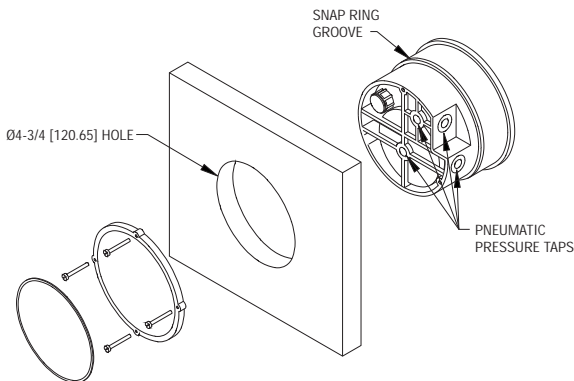

- A. PANEL MOUNTING:** Cut a 4-3/4" or 120mm dia. hole in panel and insert the complete unit from the front. Slip on the mounting ring and install the split snap ring in the groove on the bezel. Seat the mounting ring against the snap ring and thread the four screws through the tapped holes. Tighten screws against rear of panel.

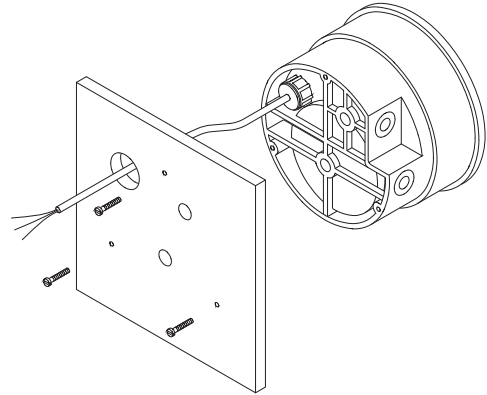

- B. SURFACE MOUNTING:** Drill (3) 3/16" dia. holes for mounting screws and (1) 7/8" dia. hole for wire assembly as shown in hole location drawing. Insert screws from rear of panel and thread into tapped holes on back of Photohelic® Switch/Gage case. If rear pressure connections are to be used, make 1/2" dia. holes located as shown in hole location drawing in left column.

Once Photohelic® Switch/Gage unit is securely mounted, plug wire assembly into 9 pin connector on rear of unit, being careful to match pin locations.

- 5. ZEROING:** Once the Photohelic® Switch/Gage is mounted in its final position, check to be sure pointer aligns with zero on scale, when no pressure is applied and both low and high pressure ports are vented to atmosphere. To adjust, turn small slotted screw at center-bottom of gage face.

MAINTENANCE

Upon final installation of the Dwyer® Photohelic® Switch/Gage, no routine maintenance is required. A periodic check of system calibration is recommended.

The Series 3000MR Photohelic® Differential Pressure Switch/Gage is not field serviceable and should be returned if repair is needed (field repair should not be attempted and may void warranty). Be sure to include a brief description of the problem plus any relevant application notes. Contact customer service to receive a return goods authorization number before shipping.