

# Sure Cross<sup>®</sup> Performance DX80 Wireless I/O Networks

## Instruction Manual

Original Instructions  
132607 Rev. L  
5 October 2017  
© Banner Engineering Corp. All rights reserved



132607

# Contents

1 The Sure Cross® Performance Wireless Network	5
1.1 Sure Cross® Performance Gateways and Nodes	5
1.2 Sure Cross® Performance GatewayPro	5
1.3 DX83 Ethernet Bridge Overview	6
1.4 Host Controller Systems	6
1.5 What is FlexPower®?	6
1.6 Sure Cross® User Configuration Tool	7
2 Features	8
2.1 DX80 Gateway and Node Components	8
2.2 DX80 Gateway and Node Wiring Chamber	8
2.3 DX80 GatewayPro	9
2.4 DX83 Ethernet Bridge	9
2.5 Wiring Diagrams	9
2.5.1 5-pin M12/Euro-style Wiring for Gateways and DX85s	10
2.5.2 5-Pin M12/Euro-style Male Quick Disconnect	10
2.5.3 DX80...C Wiring	10
2.5.4 Industrial Ethernet Wiring	10
2.6 Dimensions	11
2.6.1 Gateways and Nodes	11
2.6.2 GatewayPro	12
2.6.3 DX83 Ethernet Bridge	12
2.6.4 DX80...E Housings	13
3 Setting Up Your Wireless Network	14
3.1 Using Extended Address Mode	14
3.2 Using Performance and Non-Performance Radios in the Same Network	14
3.3 Applying Power to the Gateway or Node	15
3.4 Bind Radios to Form Networks	15
3.5 LED Behavior for the Gateways	16
3.6 LED Behavior for the Nodes	16
3.7 Conducting a Site Survey (Gateway and Nodes)	16
3.7.1 Conduct a Site Survey Using the Menu System	17
3.7.2 Conduct a Site Survey from a Gateway Board Model	18
3.7.3 Improving Your Site Survey Results	18
3.7.4 Improving Your Site Survey Results within a MultiHop Network	19
3.7.5 Additional Information	20
4 Installing Your Sure Cross® Radios	22
4.1 Mounting SureCross Devices Outdoors	22
4.1.1 Watertight Glands and NPT Ports	22
4.2 Other Installation Requirements	23
4.3 Installation Quick Tips	23
4.3.1 Create a Clear Communication Path	23
4.3.2 Increase the Height of the Antennas	23
4.3.3 Collocated Radios	24
4.3.4 Be Aware of Seasonal Changes	24
4.4 Basic Remote Antenna Installation	24
4.4.1 Weatherproof Remote Antenna Installations	25
4.4.2 Installing Remote Antennas	25
4.4.3 Mount a Dome Antenna to the Enclosure	26
4.4.4 Use an N-Type, Pole-Mounted Antenna	27
5 Advanced Setup <b>Instructions</b> and <b>Additional Information</b>	29
5.1 DX80 Menu Structure	29
5.1.1 RUN Menu	31
5.1.2 DINFO (Device Information) Menu	32
5.1.3 FCTRY (Factory) Menu	33
5.1.4 SITE (Site Survey) Menu	34
5.1.5 DVCFG (Device Configuration) Menu	35
5.1.6 DERR (Device Error) Menu	36
5.2 Web-based Configuration	37
5.2.1 Accessing the Web-based Configuration Screens	38
5.2.2 Changing the IP Address	38
5.3 Binding Mode: What does it do?	39
5.4 More Details About Extended Address Mode	39
5.4.1 Manually Choosing an Extended Address Code - Gateway	40
5.4.2 Manually Choosing an Extended Address (Binding) Code - Node	40

5.4.3	Setting the Network ID in Extended Addressing Mode	41
5.4.4	Automatic Binding Using the Menu Navigation	41
5.5	Setting the Maximum System Devices	42
5.6	Storage and Sleep Modes	42
5.7	Modbus Communication Parameters	42
5.7.1	Setting the Slave ID on a DX80 Gateway	43
5.7.2	Setting the Baud Rate	43
5.7.3	Setting Parity	43
5.8	Default Output Conditions	44
5.8.1	Host Link Failure	44
5.8.2	Gateway Link Failure	44
5.8.3	Node Link Failure	45
5.9	Defining the Units	45
5.9.1	Interpreting Register Values in the Banner Wireless System	45
5.10	Setting up the Wireless Network Using the Rotary Dials	46
5.10.1	Rotary Dial Address Mode	46
5.10.2	Setting the Network ID Using the Rotary Dials	46
5.10.3	Setting the Device Address Using the Rotary Dials	47
5.10.4	Setting Up Channel Search Mode	47
6	System Layouts	49
6.1	Stand-Alone Systems	49
6.1.1	Mapped Pairs (DX70)	49
6.1.2	Gateway with Multiple Nodes (DX80)	50
6.1.3	Gateway Configured as a Modbus Master	51
6.2	Modbus RTU	52
6.2.1	Modbus RTU Host Controlled Operation	52
6.2.2	Modbus RTU with Multiple Slave Devices	53
6.2.3	Modbus RTU with Multiple Slave Devices - Layout 2	54
6.3	Modbus/TCP and EtherNet/IP	55
6.3.1	Host Connected - DX80 GatewayPro	55
6.4	Data Radios	56
6.4.1	Data Radios	56
6.4.2	Data Radios with DX85 Modbus RTU Remote I/O Devices	56
6.4.3	Data Radios with a Gateway as the Modbus Master	57
7	Sensor <b>Connections</b>	58
7.1	Discrete Inputs	58
7.1.1	Discrete Inputs, Sourcing	58
7.1.2	Discrete Inputs, Sinking	58
7.1.3	Discrete Inputs, MINI-BEAM	58
7.2	Discrete Outputs	59
7.2.1	Discrete Outputs	59
7.3	Analog Inputs	59
7.3.1	Analog Inputs, Powered using SureCross Device Terminals	59
7.3.2	Analog Inputs, Powered from Switch Power	59
7.3.3	Analog Inputs, Powered Externally	60
7.3.4	Analog Inputs, Temperature Sensors	60
7.3.5	Analog Inputs, QT50U Long-Range Ultrasonic Sensor	60
7.4	Analog Outputs	61
7.4.1	Analog Outputs, Three-Wire Sensors	61
7.4.2	Analog Outputs, Drive Motor Controllers	61
8	Sure Cross® Power <b>Solutions</b>	62
8.1	Using 10 to 30 V dc Power	62
8.2	What is FlexPower®?	62
8.2.1	Switch Power	62
8.2.2	FlexPower with Integrated Battery	63
8.3	Battery Life Calculations	63
8.3.1	Battery Life for Some Analog Sensors	63
8.3.2	Discrete Configuration	64
8.3.3	Battery Life of Temperature and Humidity Sensor	64
8.3.4	Battery Life of Wireless Q45 Nodes	65
8.3.5	Battery Life for a P6 Node Connected to a Vibration and Temperature (VT1) Sensor	66
8.3.6	Battery Life for a Q45U Node Connected to a 1-Wire Serial Sensor	66
8.3.7	Calculating Battery Life	67
9	Maintenance	68
9.1	Replacing the Main Body Gasket	68
9.2	Replacing the Rotary Dial Access Cover	68
9.3	Battery Replacement	68
9.3.1	Replacing the Battery	68
9.3.2	Installing or Replacing the Battery (DX80 Models)	69
9.3.3	Replacing the Battery (DX99...D Models)	69

<b>10 Troubleshooting</b>	71
10.1 Startup Problems	71
10.2 LED Message Codes	71
10.3 LCD Message Codes	73
10.3.1 Modbus Message Codes for Register 8	73
10.4 Inputs and Outputs	74
10.5 Radio Link Time-Out and Recovery (Non-Host Connected Systems)	74
<b>11 Accessories</b>	76
11.1 Selecting an Enclosure	76
11.1.1 Polycarbonate Enclosures	76
11.1.2 Fiberglass Enclosures	77
11.2 Selecting an Antenna	77
11.2.1 Antennas: Rubber RP-SMA	78
11.2.2 Antennas: Dome	78
11.2.3 Antennas: Other	78
11.2.4 Antennas: Fiberglass N-Type	78
11.2.5 Antennas: Yagi N-Type	79
11.2.6 Antennas: Cellular	79
11.2.7 Antenna Cables: RP-SMA to RP-SMA	79
11.2.8 Antenna Cables: RP-SMA to N-Type	80
11.2.9 Antenna Cables: N-Type	80
11.2.10 Surge Suppressors	80
11.3 Power Supplies	80
11.3.1 DC Power Supplies	80
11.3.2 FlexPower Supplies and Replacement Batteries	81
11.4 Relays	81
11.5 Brackets and Mounting Options	82
11.6 Cables	83
11.6.1 Ethernet Cables	83
11.6.2 Adapter Cables	84
11.6.3 Splitter Cables	84
11.6.4 Euro-Style Cordsets - Single Ended	85
11.6.5 Euro-Style Cordsets - Double Ended	86
11.6.6 Other Cables	86
11.7 Other Accessories	86
11.7.1 DX85 Modbus RTU Remote I/O Devices	86
11.7.2 Cable Glands and Plugs	87
11.7.3 Hardware and Replacement Parts	87
11.7.4 Metal Housing Accessories	88
<b>12 Sure Cross® Radio Certifications</b>	89
12.1 FCC Certification, 900MHz	89
12.2 FCC Certification, 900 MHz, 1 Watt Radios	89
12.3 FCC Certification, 2.4GHz	90
12.4 Certified For Use in the Following Countries	91
12.5 Exporting Sure Cross® Radios	93
<b>13 Warnings</b>	94
13.1 Banner Engineering Corp. Limited Warranty	94
13.2 Contact Us	94

# 1 The Sure Cross® Performance Wireless Network

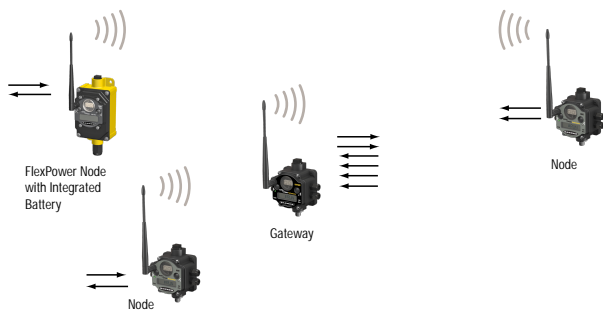

The Sure Cross® Performance wireless I/O network provides reliable monitoring without wiring or conduit installation. The SureCross wireless network operates independently or in conjunction with a host system, PLC, and/or PC software.

Each wireless network system consists of one Gateway and one or more Nodes. Devices ship with factory-defined discrete, analog, or a mix of discrete and analog inputs and outputs.

The Sure Cross® Performance network is a deterministic system—the network identifies when the radio signal is lost and drives relevant outputs to user-defined conditions. After the radio signal is reacquired, the network returns to normal operation.

## 1.1 Sure Cross® Performance Gateways and Nodes

Every wireless network must have one Gateway, which schedules communication traffic and controls the I/O configuration for the network, and one or more Nodes.

A Gateway is the master device within each radio network. Similar to how a gateway device on a wired network acts as a “portal” between networks, the Sure Cross Gateway acts as the portal between the wireless network and the host controller. When the Gateway, using its Modbus RTU RS-485 connection, is a Modbus slave to a Modbus RTU host controller, the wireless network may contain up to 47 Nodes in a single wireless network. The Gateway holds the Modbus registers of all wireless devices within the network.

A Node is a wireless network end-point device used to provide sensing capability in a remote area or factory. The Node collects data from sensors and communicates the data back to the Gateway. Nodes are available in a wide variety of power or input/output options.

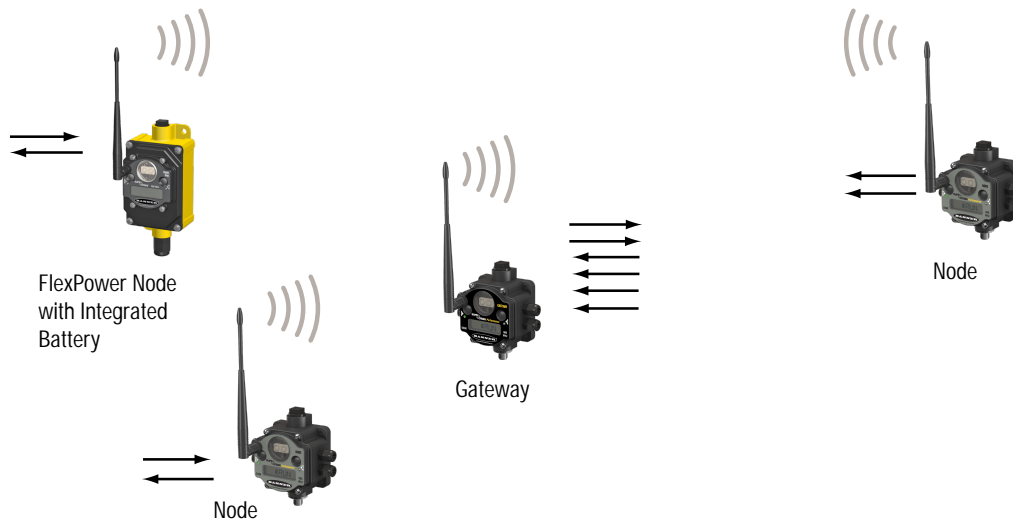

## 1.2 Sure Cross® Performance GatewayPro

The Sure Cross® Performance GatewayPro combines the function of a Sure Cross® Performance Gateway with the ability to interface to Ethernet using Modbus/TCP or EtherNet/IP™ protocols.

There are two basic models of the GatewayPro:

- DX80P\*T6\*. The T6 model acts as a protocol converter only, offering the Modbus/TCP or EtherNet/IP communication protocols.
- DX80P\*A6\*. The A6 model includes DX80 wireless network configuration, Modbus RTU master, Modbus/TCP client/server, Script Basic, e-mail, data logging, and trending.

Connect a host controller system to the GatewayPro using its industrial Ethernet connection. To connect the GatewayPro to the host system without using an Ethernet switchbox/hub, some host systems may require a crossover cable.

By default, the GatewayPro is configured to use Modbus/TCP. To use EtherNet/IP, connect the GatewayPro to a managed switch and you must use the Web Configuration tool to select EtherNet/IP. For more information, see [SureCross Wireless I/O Product Manual](#) or [Host Configuration Manual](#).

### 1.3 DX83 Ethernet Bridge Overview

---

A DX83 Ethernet Bridge connected to a DX80 Gateway functions like a DX80 GatewayPro and allows the Gateway to have I/O points. The DX83 Ethernet Bridge adds the Web page configuration ability to a Gateway-Node wireless network as well as the ability to interface to Ethernet using Modbus/TCP or EtherNet/IP protocols.

There are two basic DX83 models:

- DX83T acts as a protocol converter only, offering the Modbus/TCP or EtherNet/IP communication protocols.
- DX83A includes DX80 wireless network configuration, Modbus RTU master, Modbus/TCP client/server, Script Basic, e-mail, data logging, and trending.

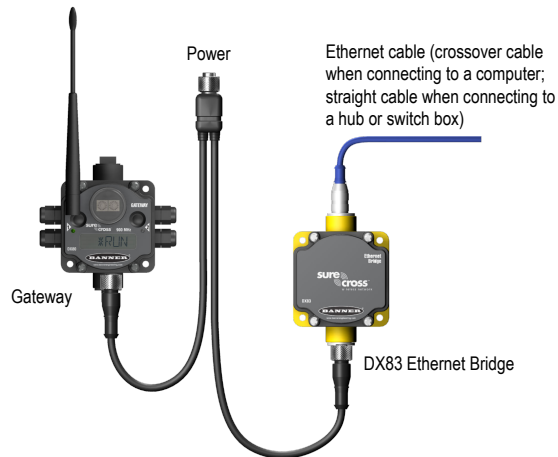

CSRB-M1250M125.47M125.73 5-pin splitter cable (black); OR  
CSB-M1240M1241 4-pin splitter cable (yellow)

Connect a DX83 Ethernet Bridge to a host system using the industrial Ethernet connection on the DX83. To connect the DX83 directly to the host system without using an Ethernet switchbox/hub, some host systems may require a crossover cable.

By default, the DX83 is configured to use Modbus/TCP. To use EtherNet/IP, you must connect the DX83 to a managed switch and you must use the Web Configuration tool to select EtherNet/IP (see [SureCross Wireless I/O Product Manual](#) or [Host Configuration Manual](#)).

### 1.4 Host Controller Systems

---

Host controller systems collect I/O data for logging, controlling other devices, or performing calculations.

Host controller systems can contain up to 15 Nodes (when using Rotary Dial Addressing Mode) or 47 Nodes (when using Extended Addressing Mode) within a single network. Inputs from Nodes within the network are transmitted to the Gateway, which communicates the information to a host system for processing. Although the Gateway is the master device within the radio network, it may be a slave to the Modbus network.

Host controlled DX80 wireless systems are configured using an Ethernet network connection and a Web page browser. An Ethernet connection can be established from a DX80 GatewayPro or a DX83 Ethernet Bridge serially connected to the DX80 Gateway.

### 1.5 What is FlexPower®?

---

Banner's FlexPower technology supplies a true wireless solution by allowing the device to operate using either 10 to 30 V dc, 3.6 V lithium D cell batteries, or solar power. This unique power management system can operate a FlexPower Node and an optimized sensing device for up to five years on a single lithium D cell.

- FlexPower Nodes may be powered from 10 to 30 V dc and use an external battery supply module to provide a battery back-up solution.
- When a FlexPower Node receives 10 to 30 V dc, it operates like a standard 10 to 30 V dc Node.
- Good applications for FlexPower devices operating from batteries include sensors that require no or very little power, including dry contacts, RTDs, and thermocouples.

The following FlexPower options are available:

- DX81-LITH, a single battery supply module;
- DX81P6, a 6-pack of lithium batteries;
- DX81H, a single battery supply module designed specifically to power the DX99 Intrinsically Safe devices with polycarbonate housings; and
- BWA-SOLAR PANEL 3W, 5W, or 20W, solar panel assemblies.



DX81-LITH: Single battery supply module

DX81H: Single battery supply module designed specifically to power the DX99 Intrinsically Safe devices with polycarbonate housings



DX81P6: Six-pack battery supply module



BWA-SOLAR PANEL 3W, BWA-SOLAR PANEL 5W, or BWA-SOLAR PANEL 20W: Includes 3 W, 5 W, or 20 W solar panel; order the controller separately when you are not using the solar panel with a DXM Wireless Controller. For more information about solar power solutions, see *Sure Cross® Solar Solutions*.

## 1.6 Sure Cross® User Configuration Tool

The User Configuration Tool (UCT) offers an easy way to link I/O points in your wireless network, view I/O register values, and set system communication parameters when a host system is not part of the wireless network. The software runs on any computer with the Windows Vista, Windows 7, Windows 8, or Windows 10 operating system.

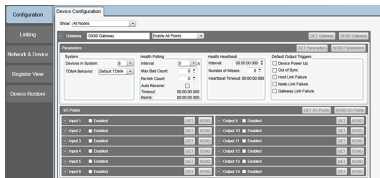

Use a USB to RS-485 adapter cable to connect a standalone DX80 Gateway to the computer. For DXM Controllers with an internal DX80 radio, connect a computer to the DXM Controller using a USB or Ethernet connection. Download the most recent revisions of the UCT software from Banner Engineering's website: [www.bannerengineering.com/wireless](http://www.bannerengineering.com/wireless).

The USB to RS-485 adapter cable is not required for the DXM Controller. For standalone DX80 Gateway devices use:

- USB to RS-485 adapter cable model BWA-UCT-900 for 1 Watt radios
- USB to RS-485 adapter cable model BWA-HW-006 for all other radios

## 2 Features

The following feature callouts refer to the DX80 Gateway and Node models, the GatewayPro, and the DX83 Ethernet Bridge. The wiring diagrams include information for connection power and sensors using the 5-pin Euro-style connect, the terminal wiring board, and the Industrial Ethernet connection on the DX83 and GatewayPro.

### 2.1 DX80 Gateway and Node Components

The DX80 Gateway and Node use the same housing and include the same physical features.



1. Port, NPT gland, or plug. If unused, install the provided plug into the 1/2 NPT threaded port. Refer to the Installation section if an IP67 seal is required.

2. Rotary switch 1 (left). Sets the Network ID (NID) to a hexadecimal value from 0 to F, for a total of 16 Network IDs. A Gateway and its corresponding Nodes must be assigned the same Network ID.

Rotary switch 2 (right). On the Gateway, sets the Gateway's LCD viewing device address. The Gateway is predefined as Device Address 0. On the Node, sets the Node's Device Address (hexadecimal 1 to F). Each Node within a network must have a unique Node Device Address.

3. Push button 1. Single-click to advance across all top-level DX80 menus. Single-click to move down interactive menus, once a top-level menu is chosen. Button 1 is also used to wake integrated battery models from the hibernation mode they ship in.

4. Push button 2. Double-click to select a menu and to enter manual scrolling mode. Double-click to move up one level at a time.

5. LED 1 and 2. Provide real-time feedback to the user regarding RF link status, serial communications activity, and the error state.

6. LCD Display. Six-character display provides run mode user information and shows enabled I/O point status. This display allows the user to conduct a Site Survey (RSSI) and modify other DX80 configuration parameters without the use of a PC or other external software interfaces. On the Node, after 15 minutes of inactivity, the LCD goes blank. Press any button to refresh the display.

7. 5-Pin M12 Euro-style quick-disconnect serial port

### 2.2 DX80 Gateway and Node Wiring Chamber

The DX80 Gateway and Node use the same housing and terminal block for wiring.

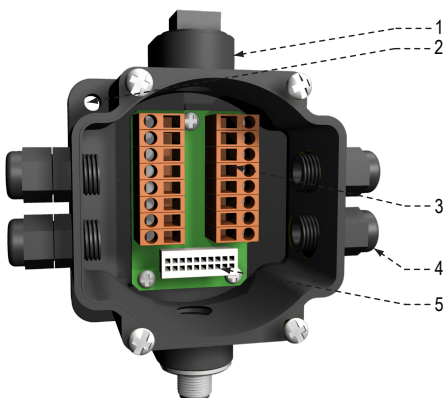

1. Housing. The rugged, industrial DX80 housing meets IEC IP67 standards.

2. Mounting hold, #10/M5 clearance. Mounting Holes accept metric M5 or UNC/UNF #10 hardware -- DIN rail mount adapter bracket available.

3. Wiring terminal strip. The 16 spring-clip type wiring terminals accept wire sizes: AWG 12-28 or 2.5 sq mm.

4. Port, PG-7 gland or blank. The PG-7 threaded ports can accept provided cable glands or blanks.

5. Ribbon connector. Ribbon cable connects wiring base to LCD/radio.

The GatewayPro has no serviceable parts inside the housing and no wiring chamber. During setup or standard operation, there should not be a need to open the GatewayPro.



## 2.3 DX80 GatewayPro

The GatewayPro has many of the same features as the Gateway and Node, including the LEDs, the buttons, LCD, and Euro-style connector.



1. Industrial ethernet port, female.
2. Rotary switch 1 (left). Sets the Network ID (NID) to a hexadecimal value from 0 to F, for a total of 16 Network IDs. A Gateway and its corresponding Nodes must be assigned the same Network ID.
3. Rotary switch 2 (right). On the Gateway, sets the Gateway's LCD viewing device address. The Gateway is predefined as Device Address 0. On the Node, sets the Node's Device Address (hexidecimal 1 to F). Each Node within a network must have a unique Node Device Address.
3. Push button 1. Single-click to advance across all top-level DX80 menus. Single-click to move down interactive menus, once a top-level menu is chosen.
4. Push button 2. Double-click to select a menu and to enter manual scrolling mode. Double-click to move up one level at a time.
5. LED 1 and 2. Provide real-time feedback to the user regarding RF link status, serial communications activity, and the error state.
6. LCD Display. Six-character display provides run mode user information and shows enabled I/O point status. This display allows the user to conduct a Site Survey (RSSI) and modify other DX80 configuration parameters without the use of a PC or other external software interfaces. On the Node, after 15 minutes of inactivity, the LCD goes blank. Press any button to refresh the display.
7. 5-pin M12 Euro-style quick disconnect serial port.

## 2.4 DX83 Ethernet Bridge

The DX83 Ethernet Bridge uses the same housing and same mounting holes as the Gateway and Node.



1. Industrial ethernet port, female.
2. Housing. The rugged, industrial DX80 housing meets IEC IP67 standards.
3. Mounting hold, #10/M5 clearance. Mounting Holes accept metric M5 or UNC/UNF #10 hardware -- DIN rail mount adapter bracket available.
4. 5-Pin M12 Euro-style quick-disconnect serial port

## 2.5 Wiring Diagrams

Use the following drawings to correctly wire power and I/O to the SureCross Wireless radio devices. For more information about wiring sensors to the SureCross devices, refer to *Sensor Connections*.

### 2.5.1 5-pin M12/Euro-style Wiring for Gateways and DX85s

Wiring the 5-pin Euro-style connector depends on the model and power requirements of the device. Connecting power to the communication pins will cause permanent damage.

5-pin M12/Euro-style Male Connector	Pin	Wire Color	Description
	1	Brown	10 to 30 V dc
	2	White	RS485 / D1 / B / +
	3	Blue	dc common (GND)
	4	Black	RS485 / D0 / A / -
	5	Gray	Comms Gnd

### 2.5.2 5-Pin M12/Euro-style Male Quick Disconnect

Integral 5-pin M12/Euro-style male quick disconnect (QD) wiring depends on the model and power requirements of the device. Not all models can be powered by 10 to 30 V dc and not all models can be powered by 3.6 to 5.5 V dc. Refer to *Specifications* to verify the power requirements of your device. For *FlexPower* devices, do not apply more than 5.5 V to the gray wire.

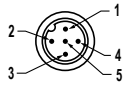
5-pin M12/Euro-style (male)	Pin	Wire Color	Powered by 10 to 30 V dc	Powered by <b>Battery</b> or <b>Battery Pack</b>
	1	Brown	10 to 30 V dc	
	2	White		
	3	Blue	dc common (GND)	dc common (GND)
	4	Black		
	5	Gray		3.6 to 5.5 V dc

### 2.5.3 DX80...C Wiring

Wiring power to the DX80...C models varies depending the power requirements of the model. Connecting dc power to the communication pins (Tx/Rx) causes permanent damage. For *FlexPower* devices, do not apply more than 5.5 V to the B+ terminal.

Terminal Label	Gateway and DX85	10 to 30 V dc Powered Nodes	<b>Battery</b> Powered Nodes
V+	10 to 30 V dc	10 to 30 V dc	
Tx/+	RS485 / D1 / B / +		
V-	dc common (GND)	dc common (GND)	dc common (GND)
Rx/-	RS485 / D0 / A / -		
B+			3.6 to 5.5 V dc

### 2.5.4 Industrial Ethernet Wiring

Use the 4-pin industrial Ethernet connection to connect the radio network to an Ethernet-based host system.

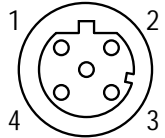
	Wire Color	Description
	1	White/orange
	2	White/blue
	3	Orange
	4	Blue

## 2.6 Dimensions

The DX80, DX83, and DX70 models all share the same housing and mounting hole dimensions.

### 2.6.1 Gateways and Nodes

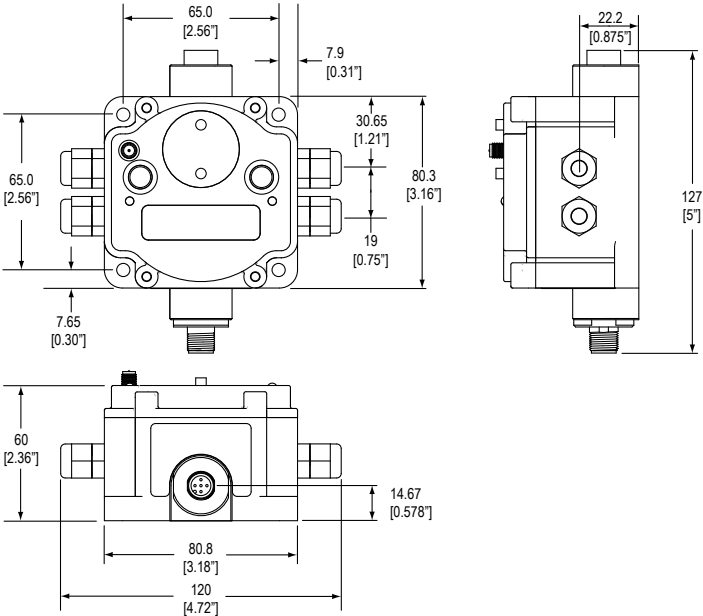

### DX80...C Gateways and Nodes

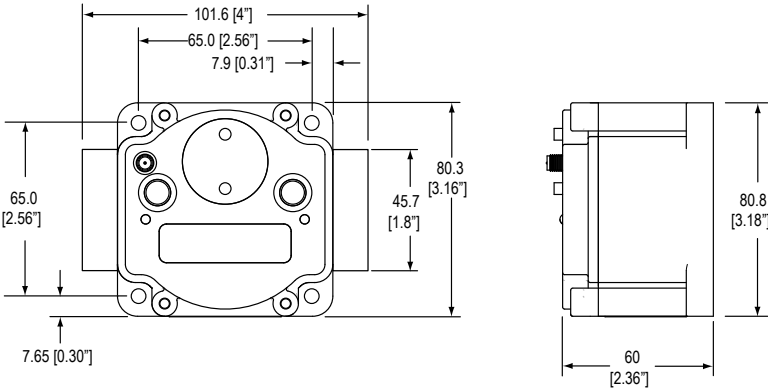

### DX80...E Housings

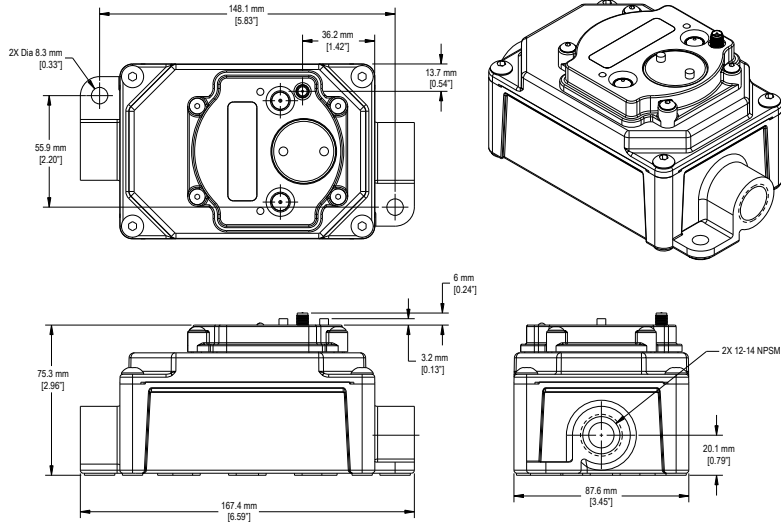

### 2.6.2 GatewayPro

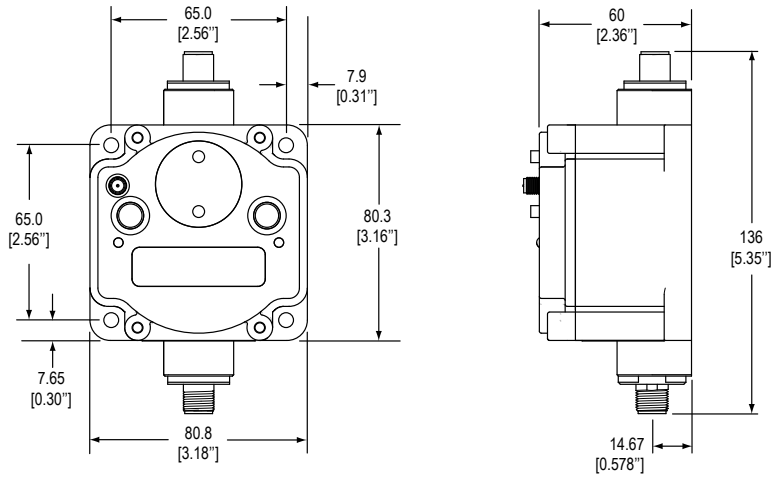

### 2.6.3 DX83 Ethernet Bridge

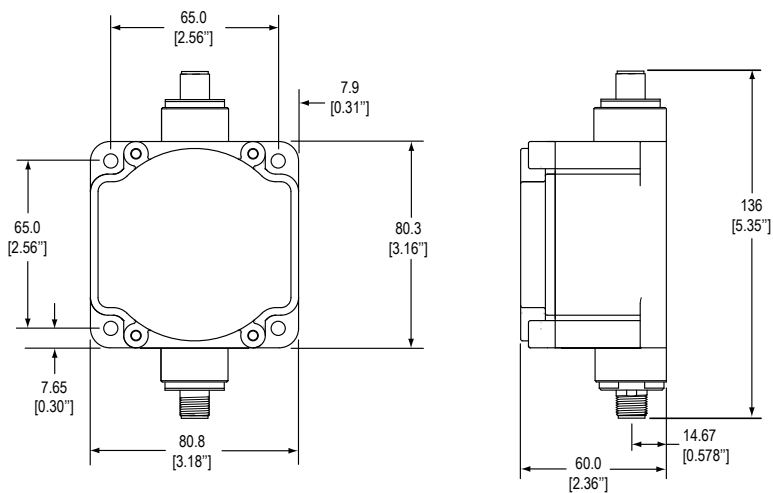

### 2.6.4 DX80...E Housings

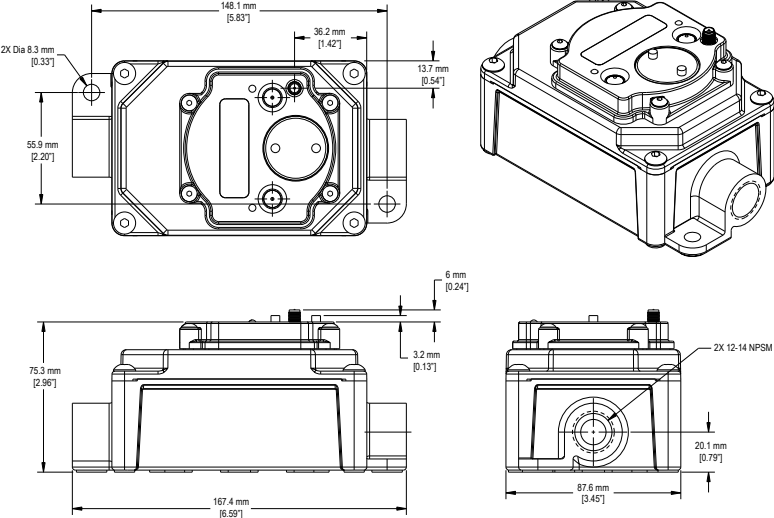

## 3 Setting Up Your Wireless Network

To set up and install your wireless network, follow these steps.

Disconnect the power from your Sure Cross devices.

1. Configure the DIP switches of all devices. For DIP switch configurations, refer to the product's datasheet.
2. If your device has I/O, connect the sensors to the Sure Cross devices. For available I/O, refer to the product's datasheet. If your device does not have I/O, skip this step.
3. Refer to the wiring diagrams to apply power to all devices.
  - For two LED models, the Gateway's LED 1 is solid green and the Node's LED 2 flashes red to indicate there is no radio link to the Gateway.
  - For one LED models, the Gateway's LED is solid green and the Node's LED flashes red to indicate there is no radio link to the Gateway.
4. Form the wireless network by binding the Nodes to the Gateway.
5. Observe the LED behavior to verify the devices are communicating with each other.
  - For two LED models, the Gateway's LED 1 is solid green and the Node's LED 1 flashes green to indicate it is communicating with the Gateway.
  - For one LED models, the Gateway's LED is solid green and the Node's LED flashes green to indicate it is communicating with the Gateway.
6. Configure any I/O points to use the sensors connected to the Sure Cross devices.
7. Conduct a site survey between the Gateway and Nodes.
8. Install your wireless sensor network components.

### 3.1 Using Extended Address Mode

Using extended address mode isolates networks from one another by assigning a unique code, the extended address code, to all devices in a particular network. Only devices sharing the extended address code can exchange data.

In addition to isolating networks, using extended addressing mode allows you to use up to 47 Nodes with a single Gateway. Without extended addressing, only 15 Nodes can communicate with a single Gateway.

The extended address code in the Gateway defaults to a code derived from its serial number, although the code can be customized using the manual binding procedure. Binding DX80 devices "locks" Nodes to a specific Gateway by teaching the Nodes the Gateway's extended address code. After the devices are bound, the Nodes only accept data from the Gateway to which they are bound.



**Important:** All SureCross Performance Gateways and Nodes are preconfigured for extended addressing mode and cannot use rotary dial address mode. Skip this step in the installation procedure for Performance products.

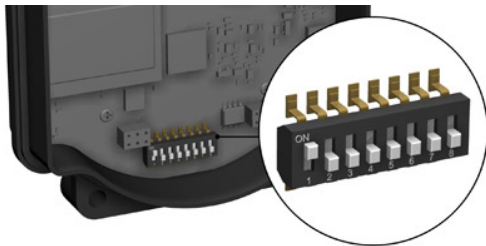

For all other SureCross DX80 models, follow these steps to activate extended address mode. After making any changes to DIP switch settings, you must cycle power to the device or the DIP switch changes will not be recognized.

1. Disconnect the Gateway and its Nodes\* from their power source.
2. Remove the top covers of all radios.
3. Move DIP switch 1 to the ON position. (Refer to the Device Configuration section of the device's data sheet for instructions on accessing the DIP switches.)
4. Apply power to the radios.

\* To cycle power to devices with batteries integrated into the housing, remove the battery for one minute.

### 3.2 Using Performance and Non-Performance Radios in the Same Network

To comply with federal regulations, the 150 mW radios and 1 Watt radios communicate differently. To mix Performance radios with non-Performance radios:

- Operate Performance radios in 250 mW mode to communicate with non-Performance radios (DIP switch 1 ON)
- Set non-Performance radios to use Extended Address Mode to communicate with Performance radios (DIP switch 1 ON)

For more detailed instructions about setting up your wireless network, refer to the Quick Start Guide (p/n [128185](#)). For more information about using Performance and non-Performance radios within the same network, refer to the technical note titled [Mixing Performance Radios and 150 mW Radios in the Same Network](#) listed on the Wireless Support - FAQs section of Banner's [Wireless website](#).

### 3.3 Applying Power to the Gateway or Node

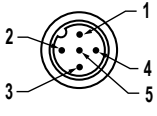
	Pin	Wire Color	Gateway (10 to 30 V dc)	Node (10 to 30 V dc)	Node (FlexPower)
	1	brown	10 to 30 V dc input	10 to 30 V dc	
	2	white	RS485 / D1 / B / +		
	3	blue	dc common (GND)	dc common (GND)	dc common (GND)
	4	black	RS485 / D0 / A / -		
	5	gray	Comms gnd		3.6 to 5.5 V dc <sup>1</sup>

- Apply power to the Gateway by connecting the 10 to 30 V dc cable as shown. The Gateway begins in RUN mode, displays the current network ID (NID), then identifies itself as a Gateway.
- Apply power to the Node by connecting the 10 to 30 V dc cable or the DX81 Battery Supply Module as shown. To apply power to a FlexPower Node with an integrated battery, install the battery into the housing. The Node starts in RUN mode, displays the current network ID, then identifies itself as a Node and lists its device ID.

### 3.4 Bind Radios to Form Networks

Binding Nodes to a Gateway ensures the Nodes only exchange data with the Gateway they are bound to. For a more detailed definition of binding mode, refer to the *Advanced Setup* section of the *SureCross Wireless I/O Networks* instruction manual.

Apply power to the Gateway and Nodes.

- Enter binding mode on the Gateway.
  - If you have a two-button Gateway, triple-click button 2
  - If you have a one-button Gateway, triple-click the button
  - If you have a Gateway with no buttons, remove the rotary dial access cover and set both the right and left rotary dials to 0, then set both the right and left rotary dials to F.



The LEDs flash alternately when the Gateway is in binding mode. Any Node entering binding mode will bind to this Gateway.

- Enter binding mode on the Node.
  - If you have a two-button Node, triple-click button 2.
  - If you have a one-button Node, triple-click the button.
  - If you have a Node with no buttons, remove the top cover and set both the left and right rotary dials to F to enter binding mode. <sup>2</sup>

The Node enters binding mode and locates the Gateway in binding mode.

For two LED models, the red LEDs flash alternately. After binding is complete, both LEDs are both solid red for a few seconds.

For one-LED models, the red and green LED flashes alternately while the Node searches for the Gateway. After binding is complete, the LED is red and green for four seconds (looks amber), then the red and green flash simultaneously (looks amber) four times.

The Node automatically exits binding mode, cycles its power, then enters RUN mode.

<sup>1</sup> Do not apply more than 5.5 V dc to the gray wire.

<sup>2</sup> Some older M-GAGE Nodes (models DX80N\*X1W0P0ZR) may require F-F binding despite having a single button.

3. Use the Node's rotary dials to assign a valid decimal Node Address (between 01 and 47). The left rotary dial represents the tens digit (0 through 4) and the right dial represents the ones digit (0 through 9) of the Node Address.
4. Repeat steps 2 and 3 for all Nodes that will communicate to this Gateway.
5. Exit binding mode on the Gateway.
  - If you have a two-button Gateway, single-click either button.
  - If you have a one-button Gateway, single-click the button.
  - If you have a Gateway with no buttons, change the Gateway's rotary dials to a valid Network ID.

Valid Network IDs are 01 through 32, in decimal, established using the rotary dials. The left dial may be set to 0, 1, 2, or 3. The right dial may be set from 0 to 9 when the left dial is at 0, 1, or 2; or set to 0 through 2 when the left dial is at 3. (Positions A through F are invalid network ID numbers.)

When installing special kits with pre-mapped I/O, indicated by device model numbers beginning in DX80K, return the rotary dials to their original positions after binding. If the rotary dials are not returned to their original positions, the I/O mapping will not work.

### 3.5 LED Behavior for the Gateways

Verify all devices are communicating properly. The radios and antennas must be a minimum distance apart to function properly. Recommended minimum distances are:

- 900 MHz 150 mW and 250 mW radios: 6 feet
- 900 MHz 1 Watt radios: 15 feet
- 2.4 GHz 65 mW radios: 1 foot

LED 1	LED 2	Gateway Status
Solid green		Power ON
Flashing red	Flashing red	Device Error
	Flashing amber	Modbus Communication Active
	Flashing red	Modbus Communication Error

For Gateway and Ethernet Bridge systems, active Modbus communication refers to the communication between the Gateway and the Ethernet Bridge. For GatewayPro systems, the Modbus communication LEDs refer to the communication internal to the GatewayPro. For Gateway-only systems, the Modbus communication LEDs refer to the communication between the Gateway and its host system (if applicable).

### 3.6 LED Behavior for the Nodes

Nodes do not sample inputs until they are communicating with the Gateway. The radios and antennas must be a minimum distance apart to function properly. Recommended minimum distances are:

- 2.4 GHz 65 mW radios: 1 foot
- 900 MHz 150 mW and 250 mW radios: 6 feet
- 900 MHz 1 Watt radios: 15 feet

LED 1	LED 2	Node Status
Flashing green		Radio Link Ok
Flashing red	Flashing red	Device Error
	Flashing red, 1 per 3 sec	No Radio Link

### 3.7 Conducting a Site Survey (Gateway and Nodes)

A Site Survey, also known as a Radio Signal Strength Indication (RSSI), analyzes the radio communications link between the Gateway and any Node within the network by analyzing the radio signal strength of received data packets and reporting the number of missed packets that required a retry.

Perform a Site Survey before permanently installing the radio network to ensure reliable communication. Activate Site Survey mode from either the Gateway buttons or the Gateway Modbus holding register 15. Only the Gateway can initiate a Site Survey, and the Site Survey analyzes the radio communications link with one Node at a time.







### 3.7.1 Conduct a Site Survey Using the Menu System

Initiate a Site Survey using the Gateway's buttons and menu system.

1. Remove the rotary dial access cover.
2. To check the status of Node 1, change the Gateway's right rotary dial to 1.  
The Gateway is now enabled to read the status of Node 1; the display scrolls through the Node's I/O status.
3. Single-click button 1 to scroll across the menu levels until reaching the Site Survey (SITE) menu.
4. Single-click button 2 to enter the Site Survey menu.
5. Single-click button 2 to begin conducting a Site Survey with the Node selected in step 2.  
The Gateway analyzes the quality of the signal from the selected Node by counting the number of data packets it receives from the Node.
6. Examine reception readings (M, R, Y, G) of the Gateway at various locations.  
Site survey results display as a percentage. M represents the percent of missed packets while R, Y, and G represent the percent of received packets at a given signal strength.  
  
M = Percent of missed packets; R = RED marginal signal; Y = YELLOW good signal; G = GREEN excellent signal. Record the results if you need troubleshooting assistance from the factory.
7. Change the Gateway's right rotary dial to conduct a Site Survey with another Node and repeat steps 2 through 6.
8. To end the Site Survey, double-click button 2.
9. Change the Gateway's right rotary dial back to 0.  
The LCD displays the device readings for the Gateway.
10. Double-click button 2 to move back to the top level menu.
11. Single-click button 1 to return to RUN mode.
12. Install the rotary dial access cover, referring to the Installation section of the manual to create an IP67 seal.

#### Interpreting the Site Survey Results

Site Survey results are listed as a percentage of data packets received and indicate the signal strength of the received signal.

	Result	Description
	Green	Packets received at a strong signal strength. A strong signal strength is greater than -90 dBm at the receiver.
	Yellow	Packets received at a good signal strength. A good signal is between -90 and -100 dBm at the receiver.
	Red	Packets received at a weak signal strength. A weak signal is less than -100 dBm at the receiver.
	Missed	Packets not received on the first transmission and requiring a retry.

Judging if the reliability of a network's signal meets the needs of the application is not just a matter of green, yellow, and red packets received. In normal operating mode, when data packets are not received, the transmitter re-sends the packet until all data is received.

For slow monitoring applications such as a tank farm, where data is required in terms of seconds or minutes, receiving most of the data in the 'red' range, indicating a weak but reliable signal, transmits enough data for accurate monitoring. Nodes positioned near the outside range of the radio signal may have 90% of the data packets received in the red zone, again indicating a weak, but reliable signal.

We recommend keeping the missed packets average to less than 25%. When the network misses more than 25% of the data packets, the signal is usually too unreliable or obstacles may be interfering with the signal. When Site Survey reports the missed packets are 25% or higher, improve the radio system performance by:

- **Mounting** the network's antennas higher to clear obstacles in the area and improve the line of sight between Sure Cross® devices
- Using higher gain antennas to focus the energy of the radio signal in a specific direction and extend the signal's range
- Adding data radios to the network to extend the range of a radio network. For more information on data radios, please refer to Banner's white paper on range extension on [www.bannerengineering.com/wireless](http://www.bannerengineering.com/wireless).

### 3.7.2 Conduct a Site Survey from a Gateway Board Model

Conducting a Site Survey, also known as an RSSI (Radio Signal Strength Indication), analyzes the radio communications link between the Gateway and any Node within the network by analyzing the radio signal strength of received data packets and reporting the number of missed packets that required a retry.

Perform a Site Survey before permanently installing the radio network to ensure reliable communication. Only the Gateway can initiate a Site Survey, and the Site Survey analyzes the radio communications link with one Node at a time. Follow these steps to conduct a Site Survey from the board module Gateway.

1. Set the Gateway's rotary dials to the Node address you'd like to conduct a Site Survey with.  
For example, to analyze the signal strength between this Gateway and Node 02, rotate the left rotary dial to 0 and the right rotary dial to 2.  
The Site Survey automatically begins running. If there is no device at address 02, the LED is solid red. If there is a device at address 02, the LED flashes amber.
2. Evaluate the signal strength. The amber LED flashes at specific rates to indicate the Site Survey results. Each signal strength represents the majority of the data packets being received at that signal strength. For example, a strong signal strength indicates the majority of the data packets were received at a strong signal, but a few may have been received at a good or weak signal strength.
  - Eight flashes per second: Very strong signal strength
  - Four flashes per second: Strong signal strength
  - Two flashes per second: Good signal strength
  - One flash per second: Weak signal strength
  - Solid amber LED: No radio communication detected
3. To exit the Site Survey, set the Gateway's rotary dials to 00. Otherwise, after 15 minutes the Gateway automatically exits Site Survey mode.  
The LED flashes green to indicate the Gateway is in standard operating mode.

### 3.7.3 Improving Your Site Survey Results

Refer to the Sure Cross Installation Guide (p/n [151514](#)) for installation details and tips and tricks for improving your radio network's performance.

If your Site Survey results have more yellow than green, consider replacing the Node's antenna with one of the following:

- Use a 2 dBi Omni dome antenna (model BWA-902-D) or a 5 dBi Omni antenna (model BWA-905-C)
- Use a 6 dBi Yagi (directional) antenna (model BWA-9Y6-A)

If the distance between devices is greater than 5,000 meters (3 miles) line-of-sight or objects, such as trees or man-made obstructions, interfere with the path, and the MISSED packet count exceeds 25 per 100 packets, consider the following steps:

- Install the antenna(s) remotely at a higher position (requires an antenna extension cable);
- Use a higher gain antenna;
- Decrease the distance between devices; or
- Use data radios to extend the position of the Gateway relative to the host system.

### Performance Levels

Referenced omni-directional and directional antennas are listed at the end of this section.

Very strong signal strength is 100 green signals (displayed on the LCD) or eight flashes per second (models without LCDs). If the included 2 dBi OMNI antenna does not achieve this signal strength, use a different omni antenna, such as the 2 dBi dome antenna (same gain, different form factor) or 5 dBi antenna (higher gain). You may also use a low-gain directional antenna, such as the 6.5 dBd Yagi antenna.

Strong signal strength is represented by some green signals and some yellow signals (very few red signals and very few missed signals) or four flashes per second. To improve your radio performance, consider using a different omni antenna, such as the 2 dBi dome antenna, 5 dBi antenna, 6 dBi antenna, or 8 dBi antenna. You may also use a low-gain directional antenna, such as the 6.5 dBd Yagi antenna. We also recommend installing the antenna(s) remotely at a higher position. Additional antenna cables are available from Banner Engineering if needed.

Good or weak signal strength equals some yellow signals and a majority of red signals (very few green signals, a small number of yellow signals, and a small to medium number of missed signals) or one to two flashes per second. To improve your radio performance, consider using one of the 6 dBi or 8 dBi omni-directional antennas or the 10 dBd directional antenna. We also recommend installing the antenna(s) remotely at a higher position. Additional antenna cables are available from Banner Engineering if needed.

No radio **communication** is when more than 50% of the radio signals are missed or a solid amber LED. To improve radio performance, use a 8 dBi omni-direction antenna or a 10 dBd directional antenna and elevate the antenna above any obstructions. The lack of signals may also be due to the distance between the Gateway (master radio) and Nodes (remote radio). If this is the case, please contact Banner Engineering for further assistance. We also recommend installing the antenna(s) remotely at a higher position. Additional antenna cables are available from Banner Engineering if needed.

### Omni-Directional (Omni) Antennas

BWA-902-D (2 dBi OMNI antenna, dome style)—For applications where a durable antenna is needed external to the radio enclosure.

BWA-9O5-C (5 dBi OMNI antenna with RP-SMA connector)—Antenna for medium antenna performance increase or to elevate the antenna above obstacles such as buildings or tall crops. We recommend using one of the following LMR200 extension cables (RP-SMA to RP-SMA):

- BWC-2MRSFRS3 (3 meters long)
- BWC-2MRSFRS6 (6 meters long)
- BWC-2MRSFRS9 (9 meters long)
- BWC-2MRSFRS12 (12 meters long)

BWA-9O6-AS (6 dBi OMNI antenna with Type N cable connector)— Antenna for strong antenna performance increase. Requires a RP-SMA to Type N converter cable (BWC-1MRSMN05). May require one of the following antenna extension cables:

- BWC-4MNFN3 (3 meters long)
- BWC-4MNFN6 (6 meters long)
- BWC-4MNFN15 (15 meters long)
- BWC-4MNFN30 (30 meters long)

Requires a surge suppression device (model BWC-LFNBMN-DC) if the antenna is external to a building, connected to other electronics, or elevated.

BWA-9O8-AS (8 dBi OMNI antenna with Type N cable connector)—Antenna for very strong antenna performance increase. Requires a RP-SMA to Type N converter cable (model BWC-1MRSMN05). May require one of the following antenna extension cables:

- BWC-4MNFN3 (3 meters long)
- BWC-4MNFN6 (6 meters long)
- BWC-4MNFN15 (15 meters long)
- BWC-4MNFN30 (30 meters long)

Requires a surge suppression device (model BWC-LFNBMN-DC) if the antenna is external to a building, connected to other electronics, or elevated.

### Directional (Yagi) Antennas

BWA-9Y6-A (6.5 dBi YAGI antenna with Type N cable connector)—Antenna for strong, directional antenna performance. Requires a RP-SMA to Type N converter cable (model BWC-1MRSMN05). May require one of the following antenna extension cables:

- BWC-4MNFN3 (3 meters long)
- BWC-4MNFN6 (6 meters long)
- BWC-4MNFN15 (15 meters long)
- BWC-4MNFN30 (30 meters long)

Requires a surge suppression device (model BWC-LFNBMN-DC) if the antenna is external to a building, connected to other electronics, or elevated.

BWA-9Y10-A (10 dBd YAGI antenna with Type N cable connector)—Antenna for very strong, directional antenna performance increase. Requires a RP-SMA to Type N converter cable (model BWC-1MRSMN05). May requires one of the following antenna extension cables:

- BWC-4MNFN3 (3 meters long)
- BWC-4MNFN6 (6 meters long)
- BWC-4MNFN15 (15 meters long)
- BWC-4MNFN30 (30 meters long)

Requires a surge suppression device (model BWC-LFNBMN-DC) if the antenna is external to a building, connected to other electronics, or elevated.

### 3.7.4 Improving Your Site Survey Results within a **MultiHop** Network

In addition to the information in [Improving Your Site Survey Results](#) on page 18, here are some tip and tricks for MultiHop radio networks.

If a repeater radio is available in the network but is not being used, enable the forced routing function on the radio with a weak signal to force it to use a nearby radio with a stronger signal strength. Reference the Banner Engineering document titled *Forced Routing Method* for more information.

If you cannot use forced routing or add a repeater radio to the network, use a 8 dBi omni-direction antenna or a 10 dBd directional antenna.

We also recommend raising the radio units to a higher elevation, either by physically moving the devices or installing the antenna(s) remotely at a higher position. Additional antenna cables are available from Banner Engineering if needed.

The absent of signals may also be due to the distance between the master (main) and slave (remote) radios. If this is the case, please contact Banner Engineering for further assistance.

### 3.7.5 Additional Information

#### SITE (Site Survey) Menu

The SITE menu displays the results of a Site Survey conducted with this Gateway.

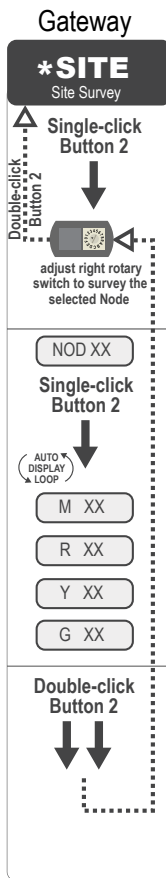

The SITE menu displays the device number of the Node the Site Survey was conducted with as well as the missed, green, yellow, and red received packet count.

The SITE menu is only available on the Gateways.

To access the SITE menu, single-click button 1 to scroll across the menu levels until reaching the Site Survey (SITE) menu.

See [Conduct a Site Survey Using the Menu System](#) on page 17.

See [Interpreting the Site Survey Results](#) on page 17.

#### Conduct a Site Survey Using Modbus Commands

Use Modbus commands sent from the host system to start a Site Survey.

To start a Site Survey using a Modbus write holding register command, send a control code of 32 (0x20) and the Node number 1 through 15 (0x01 to 0x0F) to the Gateway Modbus holding register for I/O 15.

Modbus Register		
	[15:8]	[7:0]
I/O 15	Control Code	Data Field

I/O 15 Control Messages			
Control Code	Data Field	Restrictions	Description
32	Node # 1-15	Gateway only	<p>Enable Site Survey between Gateway and Node defined by the data field. All error messages from the Gateway are ignored when running Site Survey.</p> <p>Only one Node can participate in Site Survey at a time. To disable the Site Survey, use control code 0x20 with Node 0. A Node must be enabled to run the Site Survey, then disabled before selecting the next Node.</p>

### Example Command

Modbus Register		
I/O 15	32	02

When Site Survey runs, the accumulated results are stored in the Gateway's I/O 7 and I/O 8 holding registers. The LEDs on the both the Gateway and the Node's front panel display the signal strength for the wireless RF link. The quality of the communications link is indicated by:

- Green LED = excellent signal strength
- Amber LED = good signal strength
- Red LED = poor signal strength

The signal strength is the transmitted signal strength relative to the ambient RF signal present in a specific location, or noise floor.

The Gateway also displays the Site Survey results on the LCD (for models with an LCD). For one transmit and receive interval, the Gateway saves the lowest signal strength. The LCD and Modbus registers contain the results of the last 100 samples. The totals are a running tally of the last 100 samples and are continuously updated. Four categories are displayed:

- G (green) = excellent signal strength
- Y (yellow) = good signal strength
- R (red) = poor signal strength
- M = Missed packet

To disable Site Survey, send control code 32 (0x20) and Node number 0 (0x0).

### Site Survey Data Holding

With Site Survey active, registers I/O 7 and 8 are Site Survey data holding registers that store the accumulated Site Survey results. Error collections in holding register 8 are saved when Site Survey runs and restored after Site Survey is disabled.

	Register			Example Results	
	[15:8]	[7:0]		[15:8]	[7:0]
I/O 7	Red Total	Missed Total	I/O 7	10	0
I/O 8	Green Total	Yellow Total	I/O 8	80	10



Note: This is the current register arrangement when using Modbus/TCP or Modbus RTU. In some older models, the Modbus/TCP registers are reversed (missed and yellow totals are in [8:15], red and green totals are in [0:7]).

## 4 Installing Your Sure Cross® Radios

Follow these recommendations to install your wireless network components.

### 4.1 Mounting SureCross Devices Outdoors

Use a Secondary Enclosure. For most outdoor applications, we recommend installing your SureCross devices inside a secondary enclosure. For a list of available enclosures, refer to the *Accessories* list.

Point Away From Direct Sunlight. When you are not using a secondary enclosure, minimize the damaging effects of ultra-violet radiation by mounting the devices to avoid facing intense direct sunlight.

- Mount under an overhang or other source of shade,
- Install indoors, or
- Face the devices north when installing outside.

For harsh outdoor applications, consider installing your radio inside a secondary enclosure. For a list of available enclosures, refer to the *Accessories* list.

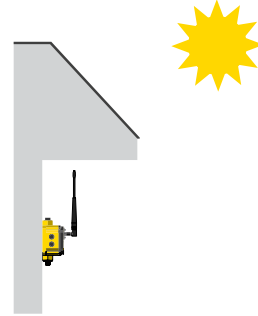

Mount **Vertically** to Avoid **Collecting** Rain. When possible, mount the devices where rain or snow will drain away from the device.

- Mount vertically so that precipitation, dust, and dirt do not accumulate on permeable surfaces.
- Avoid mounting the devices on flat or concave surfaces, especially if the display will be pointing up.

Remove Moisture and **Condensation**. If condensation is present in any device, add a small desiccant packet to the inside of the radio. To help vent the radios, Banner also sells a vented plug (model number BWA-HW-031) for the 1/2-inch NPT port of the SureCross radios.



#### 4.1.1 Watertight Glands and NPT Ports

To make glands and plugs watertight, use PTFE tape and follow these steps.

1. Wrap four to eight passes of polytetrafluoroethylene (PTFE) tape around the threads as close as possible to the hexagonal body of the gland.
2. Manually thread the gland into the housing hole. Never apply more than 5 in-lbf of torque to the gland or its cable clamp nut.<sup>3</sup>



Seal any unused access holes with one of the supplied plastic plugs. To install a watertight plug:

1. Wrap four to eight passes of PTFE tape around the plug's threads, as close as possible to the flanged surface.
2. Carefully thread the plastic plug into the vacant hole in the housing and tighten using a slotting screwdriver. Never apply more than 10 in-lbf torque to the plastic plug.

If your device has an unused NPT port, install a watertight NPT plug:

1. Wrap 12 to 16 passes of PTFE tape evenly across the length of the threads.
2. Manually thread the plug into the housing port until reaching some resistance.
3. Using a crescent wrench, turn the plug until all the plug's threads are engaged by the housing port or until the resistance doubles. Do not over-tighten as this will damage the device. These threads are tapered and will create a waterproof seal without over-tightening.

<sup>3</sup> This is equivalent to the torque generated without using tools. If a wrench is used, apply only very light pressure. Torquing these fittings excessively damages the device.

## 4.2 Other **Installation** Requirements

---

### 4.2 Reduce Chemical Exposure

Before installing any devices in a chemically harsh environment, contact the manufacturer for more information regarding the life-expectancy. Solvents, oxidizing agents, and other chemicals will damage the devices.

### 4.2 Minimize Mechanical Stress

Although these radio devices are very durable, they are sophisticated electronic devices that are sensitive to shock and excessive loading.

- Avoid mounting the devices to an object that may be shifting or vibrating excessively. High levels of static force or acceleration may damage the housing or electronic components.
- Do not subject the devices to external loads. Do not step on them or use them as handgrips.
- Do not allow long lengths of cable to hang from the glands on the Gateway or Node. Cabling heavier than 100 grams should be supported instead of allowed to hang from the housing.
- Do not crack the housing by over-tightening the top screws. Do not exceed the maximum torque of 4 in-lbf.

It is the user's responsibility to install these devices so they will not be subject to over-voltage transients. Always ground the devices in accordance with local, state, or national regulations.

### 4.2 When Installing Performance or **MultiHop 1-Watt** Radios

**Notice:** This equipment must be professionally installed. The output power must be limited, through the use of firmware or a hardware attenuator, when using high-gain antennas such that the +36 dBm EIRP limit is not exceeded.

## 4.3 **Installation** Quick Tips

---

The following are some quick tips for improving the installation of wireless network components.

### 4.3.1 Create a Clear **Communication** Path

Wireless communication is hindered by radio interference and obstructions in the path between the transmitter and receiver. To achieve the best radio performance, carefully consider the installation locations for the Gateways and Nodes and select locations without obstructions in the path.

For more information about antennas, please refer to the *Antenna Basics* reference guide, Banner document p/n 132113.

### 4.3.2 Increase the Height of the Antennas

Position the external antenna vertically for optimal RF communication. If necessary, consider changing the height of the SureCross radio, or its antenna, to improve reception. For outdoor applications, mounting the antenna on top of a building or pole may help achieve a line-of-sight radio link with the other radios in the network.

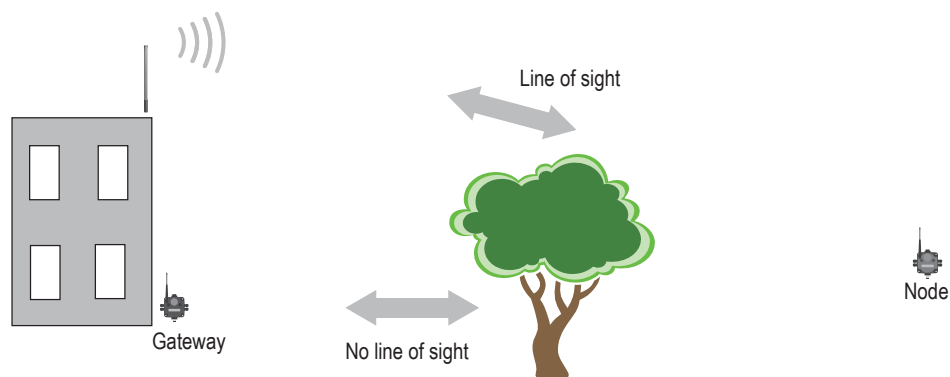

### 4.3.3 Collocated Radios

When the radio network's master device is located too close to another radio device, communications between all devices is interrupted. For this reason, always assign a unique Network ID to your wireless networks. The Network ID (NID) is a unique identifier you assign to each wireless network to minimize the chances of two collocated networks interfering with each other. Assigning different NIDs to different networks improves collocation performance in dense installations.

### 4.3.4 Be Aware of Seasonal Changes

When conducting the initial Site Survey, the fewest possible missed packets for a given link is better. However, seasonal changes may affect the signal strength and the total signal quality. Radios installed outside with 50% missed packets in the winter months may have 80% or more missed packets in the summer when leaves and trees interfere with radio reception.

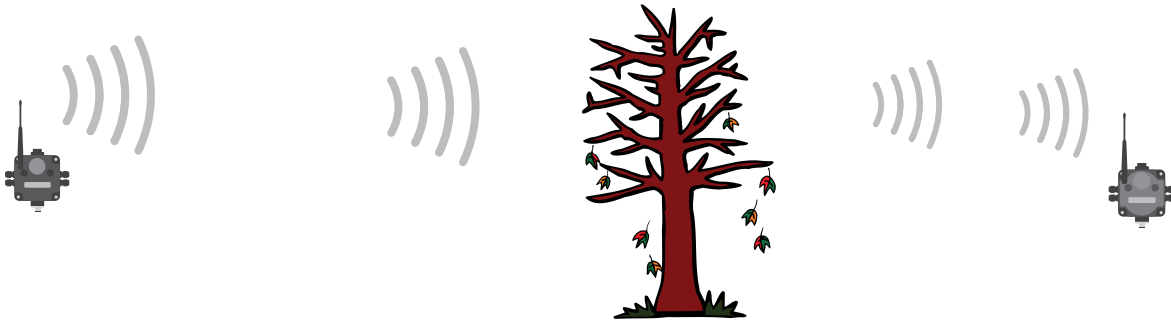

Figure 1. A good signal in winter doesn't always mean you will get the same signal strength the rest of the year.

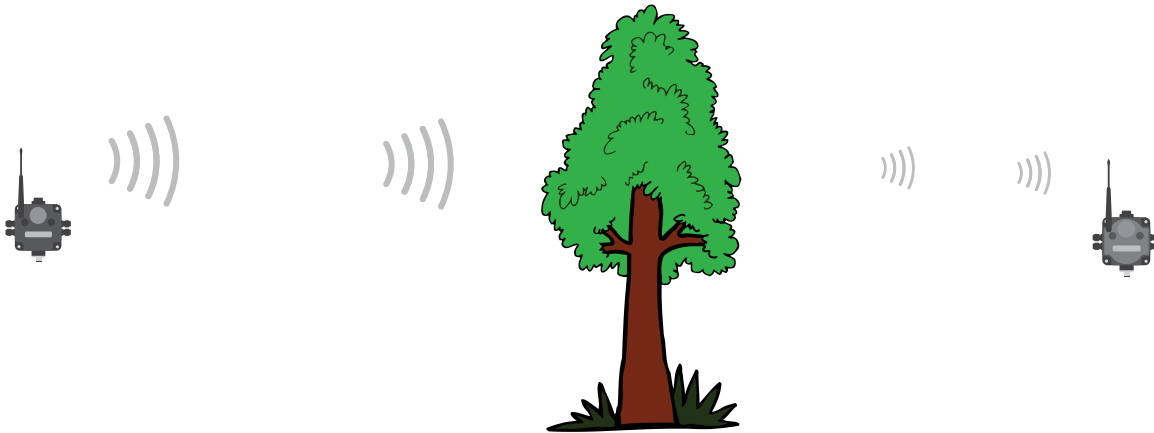

Figure 2. During spring and summer, leaves may block more of the radio signal.

## 4.4 Basic Remote Antenna Installation

A remote antenna system is any antenna system where the antenna is not connected directly to the radio; coaxial cable connects the antenna to the radio.

When installing a remote antenna system, always include a lightning arrestor or coaxial surge suppressor in the system. Remote antenna systems installed without surge protection invalidate the warranty of the radio devices.

Surge suppressors should be properly grounded and mounted at ground level near where the cabling enters a building. Install the surge suppressor indoors or inside a weatherproof enclosure to minimize corrosion or component deterioration. For best results, mount the surge suppressor as close to the ground as possible to minimize the length of the ground connection and use a single-point ground system to avoid creating ground loops.

For more detailed information about how antennas work and how to install them, refer to [Antenna Basics](#) (p/n 132113) (also included as a chapter within the product manual).



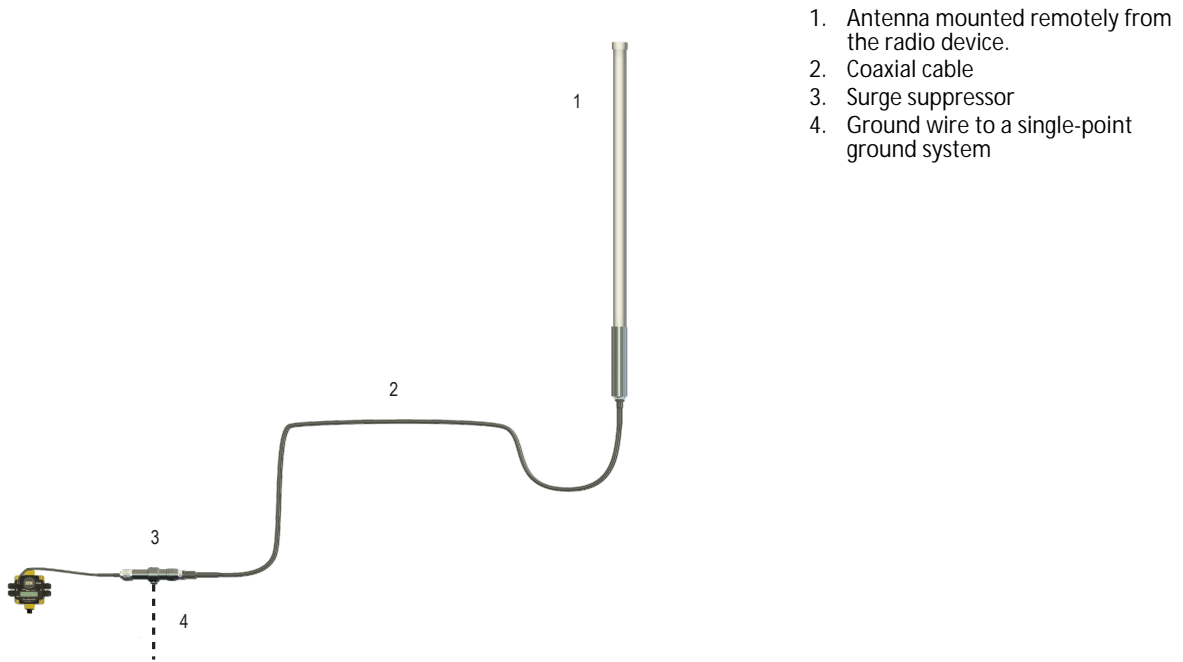

**I/O Isolation.** When connecting analog and discrete I/O to external equipment such as VFDs (Variable Frequency Drives), it may be appropriate to install interposing relays and/or loop isolation devices to protect the DX80 unit from transients, noise, and ground plane interference originating from devices or the environment. Contact Banner Engineering Corp. for more information.

#### 4.4.1 Weatherproof Remote Antenna Installations

Seal the connections with rubber splicing tape and electrical tape to prevent water damage to the cable and connections.

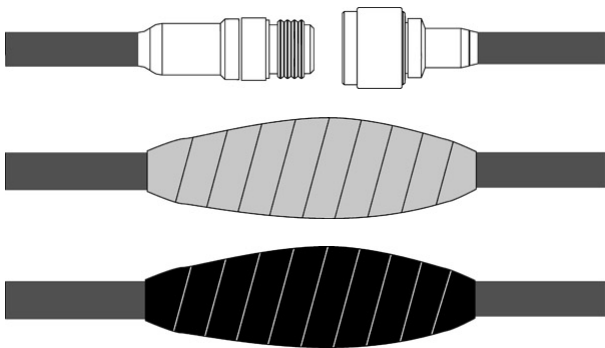

Step 1: Verify both connections are clean and dry before connecting the antenna cable to the antenna or other cable. Hand-tighten the cable connections.

Step 2: Tightly wrap the entire connection with rubber splicing tape. Begin wrapping the rubber splicing tape one inch away from the connection and continue wrapping until you are one inch past the other end of the connection. Each new round of tape should overlap about half the previous round.

Step 3: Protect the rubber splicing tape from UV damage by tightly wrapping electrical tape on top of the rubber splicing tape. The electrical tape should completely cover the rubber splicing tape and overlap the rubber tape by one inch on each side of the connection.

#### 4.4.2 Installing Remote Antennas

Install and properly ground a **qualified** surge suppressor when installing a remote antenna system. Remote antenna configurations installed without surge suppressors invalidate the manufacturer's warranty. Keep the ground wire as short as possible and make all ground connections to a single-point ground system to ensure no ground loops are created. No surge suppressor can absorb all lightning strikes; do not touch the Sure Cross® device or any equipment connected to the Sure Cross device during a thunderstorm.

### 4.4.3 Mount a Dome Antenna to the Enclosure

Use a -D dome antenna when mounting an antenna directly to the outside of the enclosure.

1. Dome antenna
2. DIN rail and DIN rail bracket
3. Enclosure

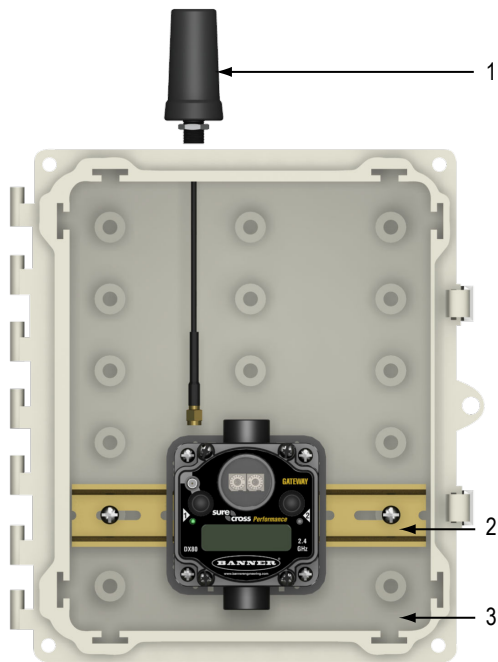

The -D dome antennas come with an 18-inch RP-SMA extension cable connected to the antenna. Use this extension cable to connect the antenna directly to the radio.

To mount, drill a hole in the enclosure and insert the antenna.

Models	Description	List Price
BWA-902-D	Antenna, Omni, 900 MHz, 2 dBd, Dome, RP-SMA MALE Box mount, 18-inch antenna cable	\$95
BWA-202-D	Antenna, Omni, 2.4 GHz, 2 dBd, Dome, RP-SMA MALE Box mount, 18-inch antenna cable	\$95

#### 4.4.4 Use an N-Type, Pole-Mounted Antenna

This antenna mounts remotely from the box, with the SureCross device mounted inside the box.

Ground the surge suppressor and antenna. Keep the ground wire as short as possible and make all ground connections to a single-point ground system to ensure no ground loops are created.

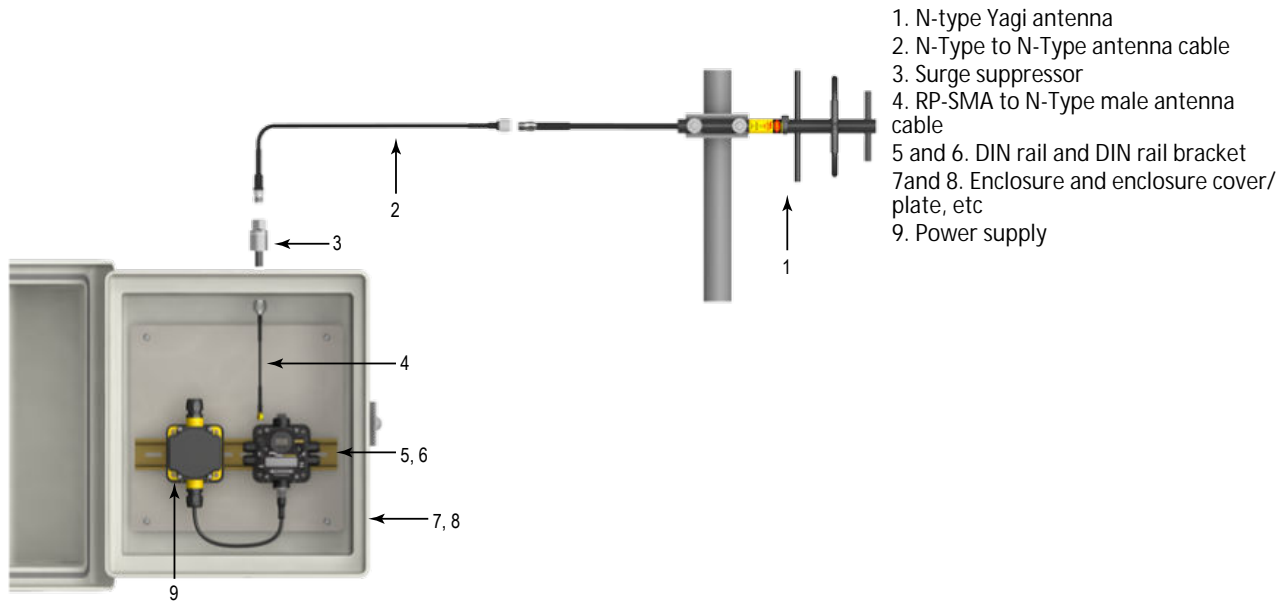

#### Directional (Yagi) Antennas with an N-Type Female Connection

##### BWA-9Y6-A

- 6.5 dBd, 6.8 × 13 inches Outdoor, 900 MHz
- Datasheet: [b\\_3145127](#)

##### BWA-9Y10-A

- 10 dBd, 6.8 × 24 inches Outdoor, 900 MHz
- Datasheet: [b\\_3145130](#)



#### Omni-Directional Fiberglass Antennas with N-Type Female Connections

##### BWA-9O6-A

- 6 dBd, Fiberglass, Full wave, 71.5 inches, 900 MHz
- Datasheet: [b\\_314512](#)

##### BWA-2O8-A

- 8.5 dBi, Fiberglass, 24 inches, 2.4 GHz
- Datasheet: [b\\_3145131](#)

##### BWA-2O6-A

- 6 dBi, Fiberglass, 16 inches (shown), 2.4 GHz
- Datasheet: [b\\_3145117](#)

##### BWA-9O6-AS

- 6 dBi, Fiberglass, 1/4 Wave, 23.6 inches (1.3 inch dia.), 900 MHz
- Datasheet: [b\\_3145125](#)

##### BWA-9O8-AS

- 8 dBi, Fiberglass, 3/4 Wave, 63 inches (1.5 inch dia.), 900 MHz
- Datasheet: [b\\_3145126](#)



Use the LMR400 cables to connect the surge suppressor to the antenna.

N-Type to N-Type Cables—LMR400 Type			
Model	Length (m)	Description	
BWC-4MNFN3	3	LMR400 N-Type Male to N-Type Female	
BWC-4MNFN6	6		
BWC-4MNFN15	15		
BWC-4MNFN30	30		

BWC-LMRSFRPB

- Surge Suppressor, Bulkhead, RP-SMA Type
- RP-SMA to RP-SMA



BWC-LFNBMN-DC

- Surge Suppressor, bulkhead, N-Type, dc Blocking
- N-Type Female, N-Type Male



Use the RP-SMA to N-Type male cables to connect the radio to the surge suppressor.

RP-SMA to N-Type Cables—LMR100 Type			
Model	Length (m)	Description	
BWC-1MRSMN05	0.5	LMR100 RP-SMA to N-Type Male	
BWC-1MRSMN2	2		

# 5 Advanced Setup Instructions and Additional Information

Refer to the following sections for advanced setup instructions or additional information on Banner's SureCross wireless technology and its uses.

## 5.1 DX80 Menu Structure

The Gateways and Nodes each have their own menu structure and options.

### 5.1 DX80 Gateway Set-up Menu

When power is applied, the DX80 begins running. The display screen auto loops through the RUN menu and communication begins between the Gateway and Node(s). Auto looping through the RUN menu is the normal operating mode for all devices on the wireless network.

From the RUN Menu (or any menu), single-click button 1 to advance through the top-level menus. The device auto display loops through the menu options if either of the RUN, DINFO, or FCTRY menus are selected. If the device is paused on the SITE, DVCFG, or DERR menu options, the display does not auto loop.

To enter manual scrolling mode, double-click button 2 at the top level menu. Use the instructions shown in the chart below to navigate the menu system. To return to the top level menus and auto display loop mode, double-click button 2 twice.

The \* before the menu name indicates a top-level menu option. The () indicate submenu items.

When using Rotary Dial Addressing Mode, use the left rotary dial to set the Network ID (NID). Once changed, allow five seconds for the devices to update to the new Network ID.

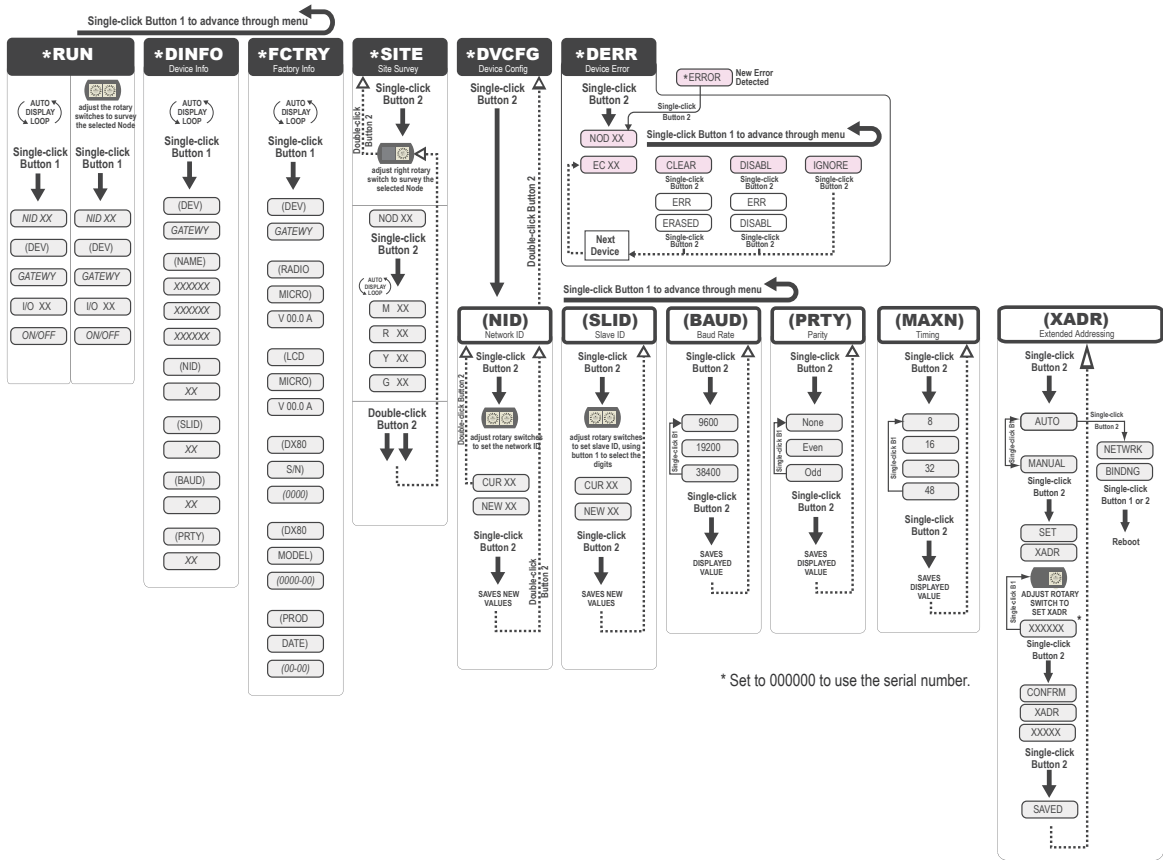

### 5.1 DX80 Node Set-up Menu

When power is applied, the DX80 begins running. The display screen auto loops through the RUN menu and communication begins between the Gateway and Node(s). Auto looping through the RUN menu is the normal operating mode for all devices on the wireless network.

From the RUN Menu (or any menu), single-click button 1 to advance through the top-level menus. The device auto display loops through the menu options if either of the RUN, DINFO, or FCTRY menus are selected. If the device is paused on the DVCFG or DERR menu options, the display does not auto display loop.

To enter manual scrolling mode, double-click button 2 at the top level menu. Use the instructions shown in the chart below to navigate the menu system. To return to the top level menus and auto display loop mode, double-click button 2 twice.

Node LCD Timeout: After 15 minutes of inactivity, the LCD screen stops displaying information. Press any button to refresh the display if the Node has entered this energy-saving mode.

The \* before the menu name indicates a top-level menu option. The () indicate submenu items.

When using Rotary Dial Addressing Mode, use the rotary dials to set the Network ID (NID) and Device ID (NADR) at any time. The left rotary dial sets the Network ID and the right rotary dial sets the Node Address. Once changed, allow five seconds for the devices to update to the new Network ID.

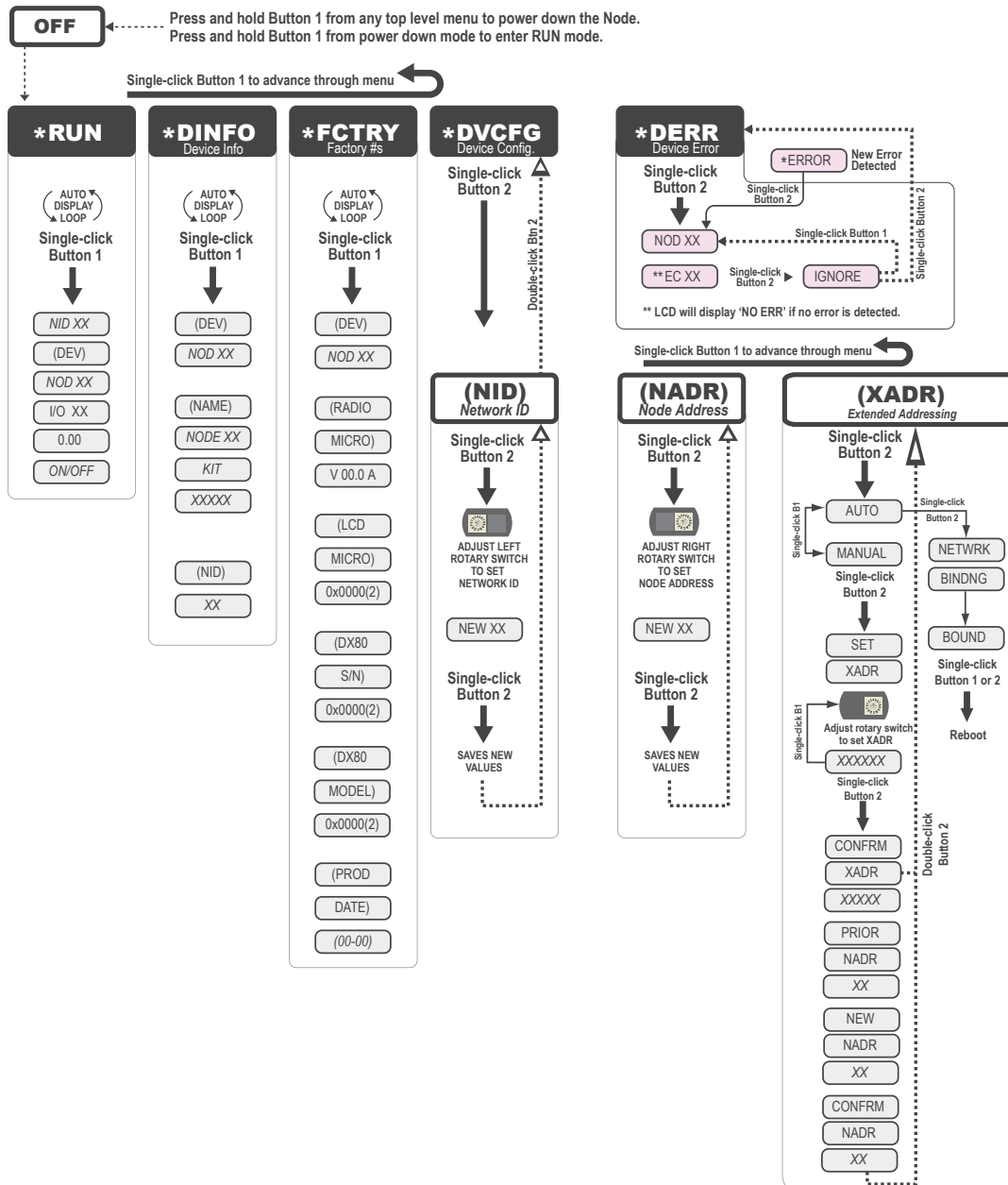

### 5.1.1 RUN Menu

The RUN menu displays the network ID (NID), device name (Gateway or Node), and the I/O values of the device.

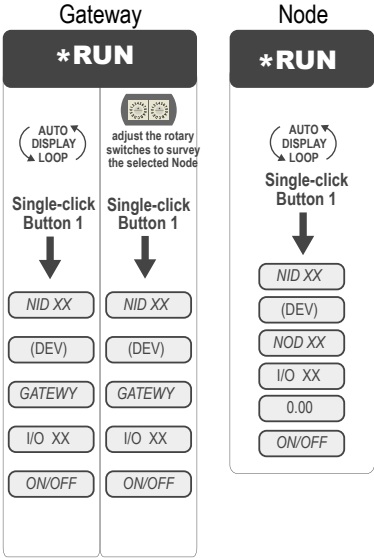

On the Gateway, the I/O displayed may be the I/O of the Gateway or of a selected Node. To view the I/O of a specific Node, set the position of the rotary dials to the Node's address. For example, to view the I/O of Node 12, set the Gateway's left rotary dial to 1 and the right rotary dial to 2.

When using extended address mode, the network ID (NID) is not used. The Network ID is typically used only in rotary dial address mode.

### 5.1.2 DINFO (Device **Information**) Menu

The DINFO menu displays some device-specific information.

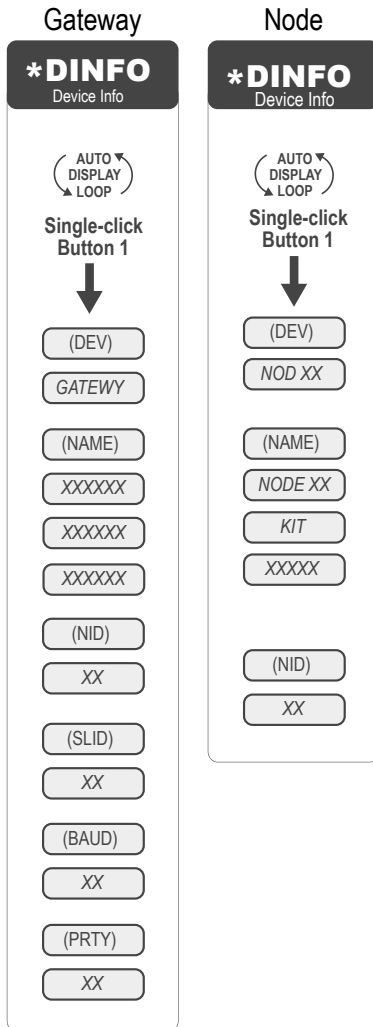

On the Gateway, the DINFO menu displays the device name, the network ID (NID), slave ID, baud rate, and parity. When in extended address mode, the DINFO menu also displays the maximum Node setting and the extended addressing (XADR), or binding, code used to form the network.

On the Node, the DINFO menu displays the device type including the Node address, the device name, and the network ID (NID).

When using extended address (binding) mode, the network ID value is no longer used by the devices. This number is not the extended address (binding) code.



### 5.1.3 FCTRY (Factory) Menu

The FCTRY menu displays the version numbers of various components within the device, including the radio micro number, the LCD number, the device's serial number, the device's model number, and the production date.

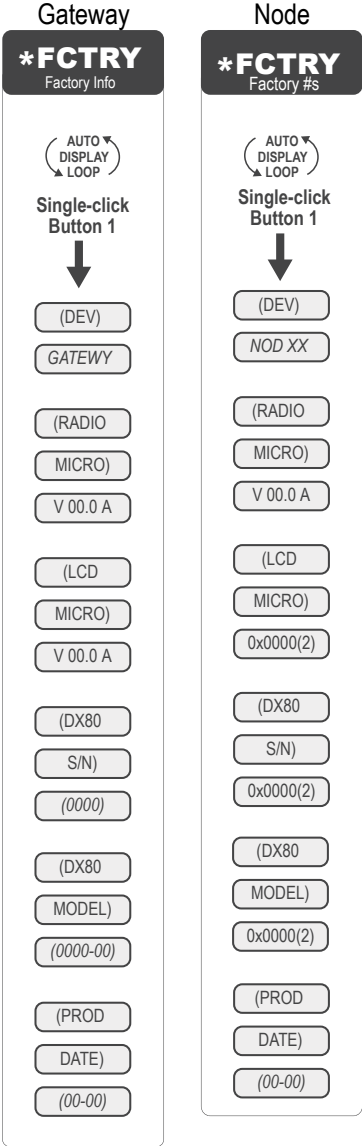

If you call Banner Engineering for technical support, having this information available may help diagnose your particular problem.

### 5.1.4 SITE (Site Survey) Menu

The SITE menu displays the results of a Site Survey conducted with this Gateway.

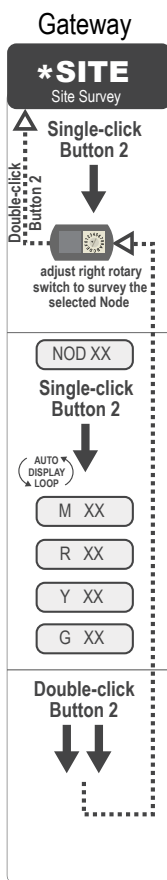

The SITE menu displays the device number of the Node the Site Survey was conducted with as well as the missed, green, yellow, and red received packet count.

The SITE menu is only available on the Gateways.

To access the SITE menu, single-click button 1 to scroll across the menu levels until reaching the Site Survey (SITE) menu.

See [Conduct a Site Survey Using the Menu System](#) on page 17.

See [Interpreting the Site Survey Results](#) on page 17.

### 5.1.5 DVCFG (Device Configuration) Menu

On Gateways, the DVCFG menu allows users to set various device-specific parameters, including the network ID (NID), slave ID (SLID), baud rate, and parity. In extended address mode, use this menu to also set the maximum number of radio devices (MAXN) within the network and the extended address binding code (XADR).

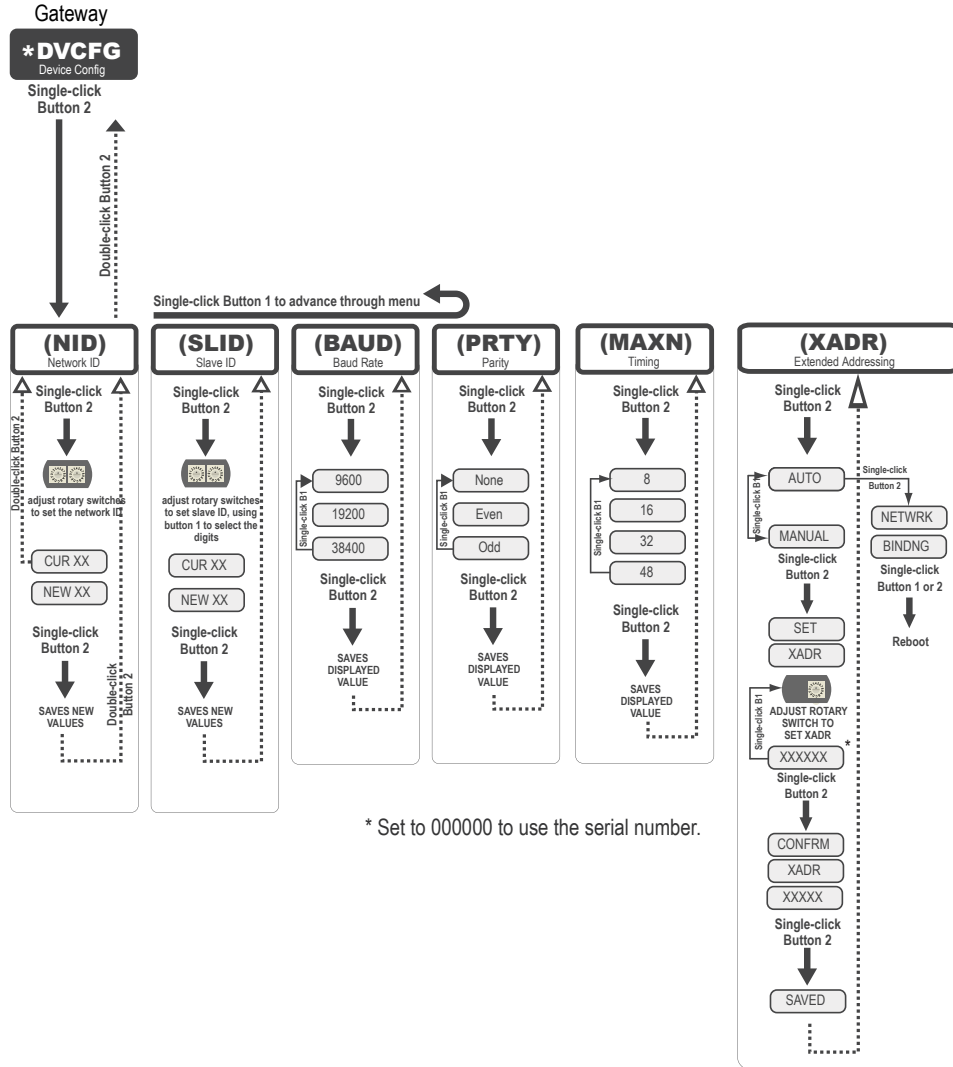

- Baud and Parity. The options for baud rate are: 19200, 38400, or 9600. For parity, select None, Even, or Odd.
- Extended Address (Binding) Code. Binding Nodes to a Gateway ensures the Nodes only exchange data with the Gateway they are bound to. After a Gateway enters binding mode, the Gateway automatically generates and transmits a unique extended addressing (XADR), or binding, code to all Nodes within range that are also in binding mode. The extended addressing (binding) code defines the network, and all radios within a network must use the same code.
- Max Nodes. Selecting the maximum number of system radio devices (Gateway and all Nodes) changes the timing for the wireless network. For example, if you are running four Nodes in your wireless network, set the system's maximum device count to 8. This allows up to 8 radio devices, including the Gateway, in the wireless network and offers the highest throughput, 62.5 milliseconds, for each Node. The choices are 8, 16, 32, and 48 devices.
- Network ID. The Network ID (NID) is a unique identifier you assign to each wireless network to minimize the chances of two collocated networks interfering with each other. Assigning different NIDs to different networks improves collocation performance in dense installations.
- Slave ID. The slave ID is an identifying number used for devices within a Modbus system. By default, Gateways are set to Modbus Slave ID 1. When using more than one Modbus slave, assign each slave a unique ID number.

On Nodes, use the DVCFG to set the network ID (NID) and extended address binding code (XADR). The Node address (NADR), also referred to as a Node ID or device address, is only functional on some models.

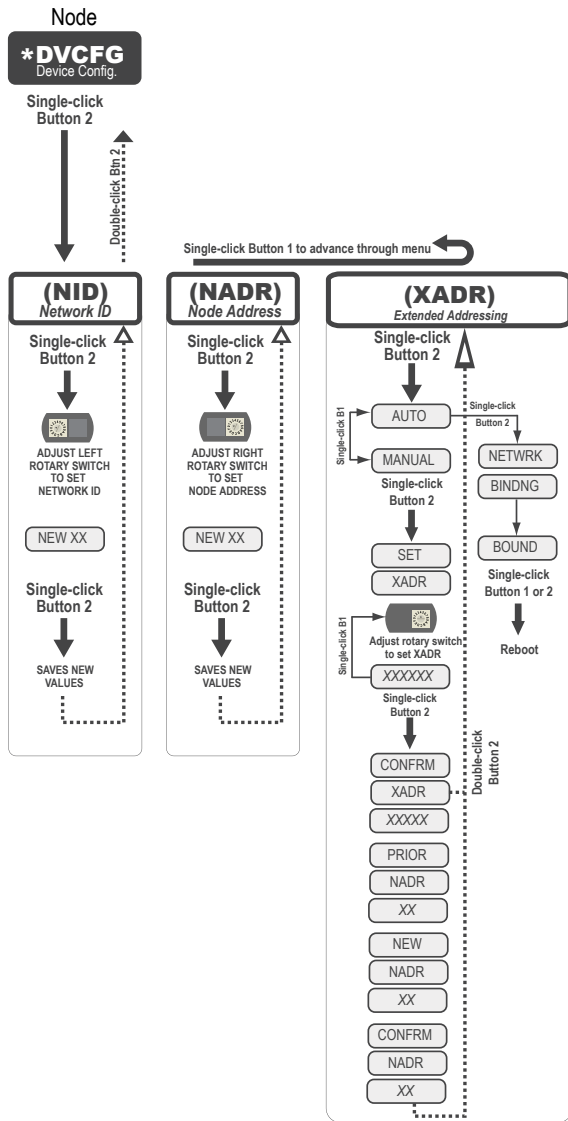

### 5.1.6 DERR (Device Error) Menu

Use the DERR menu to manage device error messages.

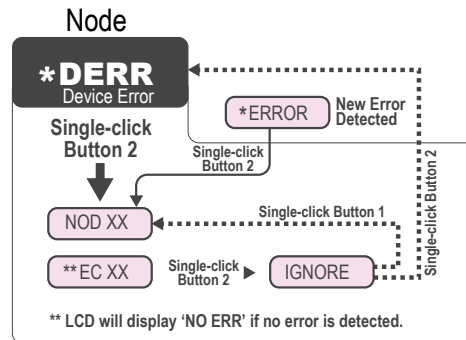
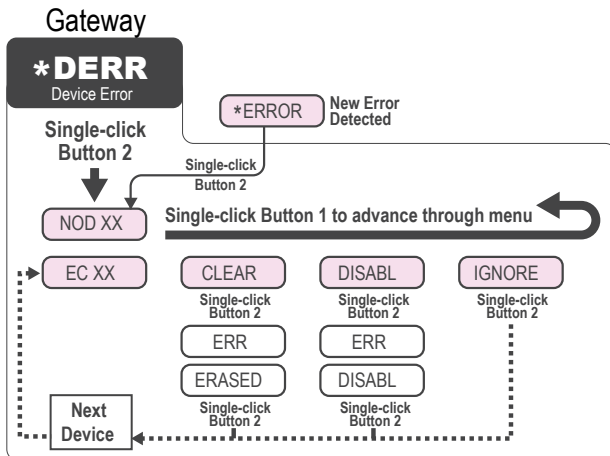

On the Gateway use the DERR menu to clear, disable, or ignore error messages generated by devices within the network. The Node number that generated the error and the error code (EC) display onscreen. Single-click button 1 to advance through the menu of CLEAR (clear this particular instance of the error from the system), DISABL (disable this particular error from appearing from this specific Node), and IGNORE (ignore this error but do not remove it from the system). After the error messages for a Node are cleared, disabled, or ignored, errors for any additional Nodes display on the Gateway's LCD.

On the Node use the DERR menu to view and ignore error messages for that Node.

### 5.2 Web-based Configuration

The SureCross wireless systems are configured using an Ethernet network connection and a common Web page browser. An Ethernet connection can be established from a GatewayPro or from a DX83 Ethernet Bridge serially connected to the Gateway.

The Ethernet Bridge and GatewayPro each ship with an Ethernet crossover cable. One end of the cable is a RJ45 connector and the other end is an industrial Ethernet connector. This cable is designed to be connected directly to a computer.

#### 5.2 Example Layout #1

When connecting a Gateway to a host system, the wireless network must be configured using the User Configuration Tool (UCT). When you are not using a GatewayPro or Ethernet Bridge, you cannot configure the wireless network using the Web Configurator.

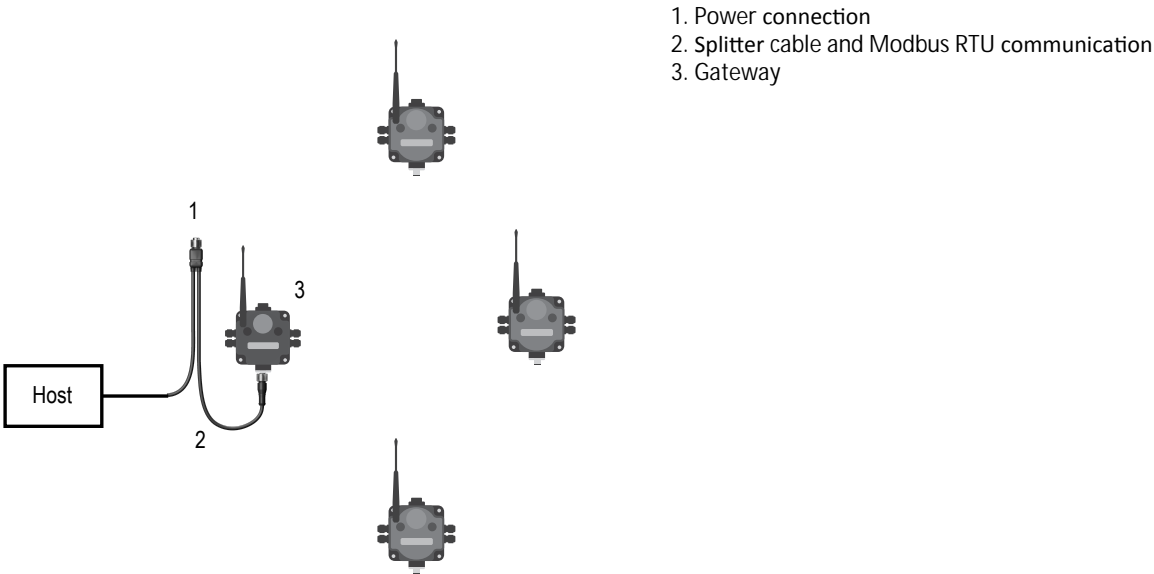

#### 5.2 Example Layout #2

This system uses a GatewayPro connected directly to a host system using an Ethernet crossover cable. This system can be configured using the web pages.

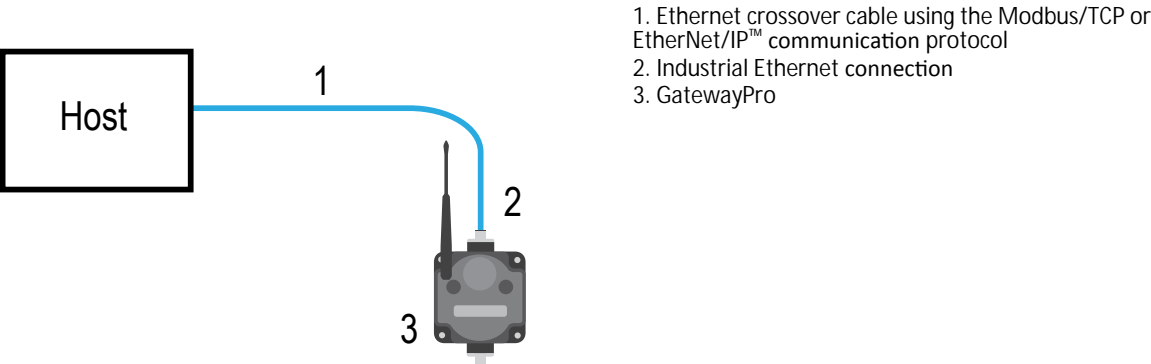

## 5.2 Example Layout #3

This example system layout may also be configured using the web pages. Instead of using a GatewayPro to connect to the host system, a Gateway and Ethernet Bridge is used to achieve the same function. In this configuration, the Gateway is Modbus Slave 1.

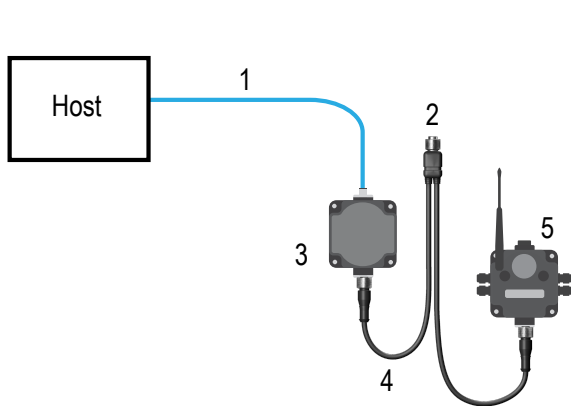

1. Ethernet crossover cable using the Modbus/TCP or EtherNet/IP communication protocol
2. Power connection
3. DX83 Ethernet Bridge
4. Splitter cable CSRB-M1250M125.47M125.73 using Modbus RTU
5. Gateway

Typically, the Modbus RTU connection at a GatewayPro is not used because the GatewayPro contains a master and slave device. The Modbus RTU factory default settings for a standard Gateway are: 19200 baud; 8 data bits; No stop bits; 1 parity bit; Modbus Slave ID 1.

### 5.2.1 Accessing the Web-based Configuration Screens

The configuration Web pages are served from the DX83 Ethernet Bridge or GatewayPro and are accessed using any Internet browser.

Before accessing the Web-based configuration screens, configure the browser for a direct connection to the Internet. If you are experiencing problems connecting, verify the browser is not set to use a proxy server. Use a crossover Ethernet cable when connecting directly from a host computer to the DX83 Ethernet Bridge or GatewayPro; use a standard Ethernet cable when connecting through a switch or Ethernet hub.

The factory default IP address for the DX83 Ethernet Bridge or GatewayPro is: 192.168.0.1 To change the default IP address, set up the host PC with an IP address different from the Ethernet Bridge or GatewayPro IP addresses. (Refer to Banner document p/n 133116 for detailed instructions on setting up the host computer's network IP address.) For example, change the PC host IP address to: 192.168.0.2. To access the configuration screens, follow these steps.

1. Open a Web browser and log into the Ethernet Bridge or GatewayPro by typing the IP address in the browser location window: <http://192.168.0.1>.



The Web home page for the Ethernet Bridge or GatewayPro displays.

2. Click on any tab at the top of page to log into the configuration software.



3. Enter `system` as the user name and `admin` as the password.

After making your changes and saving the file, close the browser to log out of the configuration system.

### 5.2.2 Changing the IP Address

Use the page tabs at the top of the page to select the hierarchical path: `System > Setup > Network`. To change the IP address, type in the new IP address and click the `Change IP` button. The IP address change activates when the Ethernet Bridge or GatewayPro reboots (cycles power).



Important: Verify the new IP address is correct before cycling power to the device. After the IP address is changed, you must enter in the new IP address to access the Web page-based configuration screens. Write down the new IP address (and any other changed parameters on this screen) or print this page and file for your record.

### 5.3 Binding Mode: What does it do?

Binding Nodes to a Gateway ensures the Nodes only exchange data with the Gateway they are bound to. After a Gateway enters binding mode, the Gateway automatically generates and transmits a unique extended addressing (XADR), or binding, code to all Nodes within range that are also in binding mode. The extended addressing (binding) code defines the network, and all radios within a network must use the same code.

After binding your Nodes to the Gateway, make note of the binding code displayed under the \*DVCFG > XADR menu on the Gateway's LCD. Knowing the binding code prevents having to re-bind all Nodes if the Gateway is ever replaced.

### 5.4 More Details About Extended Address Mode

During automatic binding, the Gateway broadcasts the extended address code to all Nodes currently in binding mode. To manually bind, enter the extended address code manually into each network device. Manually binding is particularly useful when replacing or upgrading network devices.

Users of the DX80 product do not need to be aware of other nearby networks to ensure their network does not unintentionally exchange data with other networks. However, assigning different NIDs to different networks improves collocation performance in dense installations; this is true whether the network is in standard addressing mode or extended addressing mode.



Important: The extended addressing code is independent from the system network ID (NID). Consequently, multiple networks can share a NID and will not exchange data; the networks are completely isolated from one another.

	Rotary Switch Mode	Extended Address Mode
Menus		There are more menu options in extended address mode.
Rotary Dials	The left rotary dial sets the Network ID and the right dial sets the Device ID/Address.	On the Gateway, both rotary dials, while in the (NID) menu, set the Network ID. On the Node both rotary dials are used to set the Device ID.
Nodes in Network	A maximum of 15 Nodes can be used in the wireless network	A maximum of 47 Nodes (48 total devices) can be used in the wireless network.

### 5.4.1 Manually Choosing an Extended Address Code - Gateway

Manually choosing the extended address code is useful when replacing components of an existing wireless network.

To determine the existing extended address code, access the DINFO (Device Information) menu of either the existing Gateway or another Node in the network. Follow the submenu structure to the XADR display for that device.

1. Remove the Gateway's top cover.
2. Move DIP switch 1 to the ON position to activate Extended Addressing Mode.
3. Apply power to the Gateway.  
The Gateway's LCD shows POWER, then RUN.
4. On the Gateway, single click button 1 to advance across the menus, stopping at the DVCFG menu.  
The Gateway's LCD shows (DVCFG).
5. Single click button 2 to select DVCFG. Single click button 1 to select from the available menu options, stopping at XADR.
6. Single click button 2 to enter the XADR menu.  
AUTO is automatic binding mode and uses the Gateway's serial number as the extended address code.
7. Single click button 1 to select manual mode.
8. Single click button 2 to enter manual mode.  
MANUAL allows the user to manually enter an extended address code.
9. Single click button 2 to advance to the extended address code entry step.  
After entering manual mode, use the right rotary dial to select the digits of the extended address code. The LCD shows SET XADR 000000.
10. Use the right rotary switch to begin setting the extended address code. Digit selection begins with the left most digit. After selecting the first digit, single click button 1 to advance right to the next digit. All six digits must be filled, even if it is with leading zeros. For example, to use 2245 as the code, enter 002245 into the device.  
To use the Gateway's serial number, enter 000000 as the extended addressing code.
11. Continue entering the code using a single click of button 1 to advance from left to right.  
After reaching the sixth digit, the curser returns to the first digit.
12. Single click button 2 when code entry is complete.  
The Gateway LCD displays the entered value for confirmation by showing CONFRM XADR, then repeating back your value.
13. Single click button 2 to save the code and exit the XADR menu.

When entering the extended address code, the digits auto fill with whatever position the rotary switch is currently in. For example, after entering the 00 part of the extended address code 002245, the third digit auto fills with a 0 until the rotary dial is rotated to 2.

After manually changing the extended address code on a Gateway in an existing network, change the extended address code for all Nodes in that network by either manually setting the code on all Node(s) or by beginning the automatic binding sequence on the Gateway and auto-binding all the Node(s).

### 5.4.2 Manually Choosing an Extended Address (Binding) Code - Node

Manually select the extended address, or binding, code when replacing components of an existing wireless network.

To determine the existing extended address code, access the DINFO (Device Information) menu of either the existing Gateway or another Node in the network. Follow the submenu structure to the XADR display for that device.

1. Remove the Node's top cover.
2. Move DIP switch 1 to the ON position to activate extended address mode.
3. Apply power to the Node.\*  
The LCD displays POWER, then RUN.
4. On the Node, single click button 1 to advance across the menus, stopping at the DVCFG menu.
5. Single click button 2 to select DVCFG. Single click button 1 to select from the available menu options, stopping at XADR.
6. Single click button 2 to enter the XADR menu.  
AUTO is automatic binding mode and uses the Gateway's serial number as the extended address code.
7. Single click button 1, stopping at manual mode.  
MANUAL allows the user to manually enter an extended address code.
8. Single click button 2 to enter manual mode.
9. Single click button 2 to enter the extended address code entry step.  
The LCD shows SET XADR 000000.
10. Use the right rotary switch to begin setting the extended address code. Digit selection begins with the left most digit. After selecting the first digit, single click button 1 to advance right to the next digit. All six digits must be filled, even if it is with leading zeros. For example, to use 2245 as the code, enter 002245 into the device.
11. Continue entering the code using a single click of button 1 to advance from left to right.  
After reaching the sixth digit, the curser returns to the first digit.



12. Single click **button 2** when code entry is complete. The Node LCD displays the entered value for confirmation. The LCD shows CONFRM XADR XXXXXX.
13. If the rotary dial hasn't been returned to the previous Node address (device address or ID), the LCD displays the prior setting as a reminder. Return the rotary dial to its previous Node address.
14. The new Node address setting displays (NEW NADR XX).
15. The Node confirms the new Node address by displaying CONFRM NADR XX.
16. Double click **button 2** to exit the XADR menu and to return to RUN mode.

When entering the extended address code, the digits auto fill with whatever position the rotary switch is currently in. For example, after entering the 00 part of the extended address code 002245, the third digit auto fills with a 0 until the rotary dial is rotated to 2.

\* For devices with batteries integrated into the housing, remove the battery for one minute to cycle power to the device.

### 5.4.3 Setting the Network ID in Extended Addressing Mode

Use the menu system to set the Network ID when using extended address mode.

1. From the top level menus, single-click **button 1** to advance through the menus, stopping at DVCFG (Device Configuration). The Gateway's LCD displays \*DVCFG
2. Single-click **button 2** to enter the DVCFG menu options and stop at (NID). The Gateway's LCD displays (NID)
3. Single-click **button 2**. Enters the (NID) menu option.
4. Using both rotary dials on the Gateway, select a Network ID. The left rotary dial acts as the left digit and the right rotary dial acts as the right digit of the Network ID. In extended addressing mode, the Network ID can only be set from the rotary dials while in the (NID) menu.

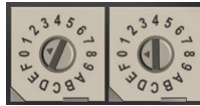

Any Nodes bound to this Gateway 'follow' the Gateway to the new Network ID automatically. The current Network ID and the new Network ID display on the LCD panel.

5. Single-click **button 2**. Saves the new values.
6. Double-click **button 2**. Exits this submenu and the LCD displays (NID).
7. Double-click **button 2**. Exits to the main menu system and returns to RUN mode. The LCD displays \*DVCFG.

### 5.4.4 Automatic Binding Using the Menu Navigation

The easiest way to bind the Gateway to its Nodes is by triple clicking **button 2** to enter automatic binding mode. If you would prefer to begin automatic binding mode using the menu structure instead of the buttons, follow these steps.

Before making any changes to the DIP switches, disconnect the power to the devices. For devices with batteries integrated into the housing, remove the battery.

1. On the Gateway: remove the top cover.
2. Move DIP switch 1 to the ON position. Extended Addressing Mode is activated using DIP switch 1.
3. Apply power to the Gateway. The Gateway's LCD displays POWER, then \*RUN.
4. On the Gateway, single click **button 1** to advance across the menus, stopping at the DVCFG menu. The Gateway's LCD displays (DVCFG).
5. Single click **button 2** to select DVCFG. Single click **button 1** to select from the available menu options, stopping at XADR. The Gateway's LCD displays (XADR).
6. Single click **button 2** to enter XADR mode. When the display reads (AUTO), single click **button 2** again to begin the automatic binding mode. The LEDs flash alternately when the Gateway is in binding mode. Any Node entering binding mode will bind to this Gateway. The Gateway's LCD displays NETWRK BINDNG.
7. On the Node: remove the top cover.
8. Move DIP switch 1 to the ON position. Extended address mode is activated using DIP switch 1.

9. Apply power to the Node.  
The Node's LCD displays POWER, then \*RUN.
10. On the Node, single click **button 1** to advance across the menus, stopping at the DVCFG menu.  
The Node's LCD displays (DVCFG).
11. Single click **button 2** to enter the DVCFG menu.
12. Single click **button 1** to select from the available submenu options, stopping at XADR.  
The Node's LCD displays (XADR).
13. Single click **button 2** to enter the XADR submenu.
14. When the display reads (AUTO), single click **button 2** to begin the automatic binding mode.  
The Node enters binding mode. The Node's LCD displays NETWRK BINDNG. When the Node is bound, the LEDs are both solid red for a few seconds. The Node cycles its power, then enters RUN mode.
15. Use both of the Node's rotary dials to assign a decimal Node address between 01 and 47.



The left rotary dial represents the tens digit (0–4) and the right dial represents the ones digit (0–9) of the device address.

16. Repeat steps 7 through 15 for each additional Node that needs to communicate to that Gateway.
17. On the Gateway: single click **button 1** or **button 2**.  
When **button 1** or **2** is pressed, the Gateway exits binding mode and reboots. The Gateway's LCD displays POWER, then \*RUN.

For devices with batteries integrated into the housing, remove the battery for one minute to cycle power to the device. After making any changes to DIP switch settings, you must cycle power to the device or the DIP switch changes will not be recognized.

## 5.5 Setting the Maximum System Devices

To set the maximum number of devices in your system, use the MAXN submenu, located under the \*DVCFG (Device Configuration) menu.

Selecting the maximum number of system radio devices (Gateway and all Nodes) changes the timing for the wireless network. For example, if you are running four Nodes in your wireless network, set the system's maximum device count to 8. This allows up to 8 radio devices, including the Gateway, in the wireless network and offers the highest throughput, 62.5 milliseconds, for each Node. The choices are 8, 16, 32, and 48 devices.

## 5.6 Storage and Sleep Modes

**Storage Mode** (applies to battery-powered models only)—While in storage mode, the radio does not operate. All Sure Cross® radios powered from an integrated battery ship from the factory in storage mode to conserve the battery. To wake the device, press and hold **button 1** for 5 seconds. To put any FlexPower® or integrated battery Sure Cross radio into storage mode, press and hold **button 1** for 5 seconds. The radio is in storage mode when the LEDs stop blinking, but in some models, the LCD remains on for an additional minute after the radio enters storage mode. After a device has entered storage mode, you must wait 1 minute before waking it.

**Sleep Mode** (applies to both battery and 10–30 V dc powered models)—During normal operation, the Sure Cross radio devices enter sleep mode after 15 minutes of operation. The radio continues to function, but the LCD goes blank. To wake the device, press any **button**.

## 5.7 Modbus Communication Parameters

To access the Modbus device, you may first need to configure system-level communication parameters on the Gateway.

The following procedures are necessary to change the Gateway's slave ID, baud rate, and parity. Setting up the Network and Device IDs, powering up the devices, and conducting the Site Survey for a host-connected network is the same as for the non-host DX80 or DX80 Performance wireless system. All device I/O for the network is accessed using the host/master device.

Parameter	Default Value	Description
Slave ID	1	Defines the slave number (01–99) for the serial Modbus RTU protocol. When operating more than one network with a Modbus Master device, change the Slave IDs.
Baud Rate	19200	Defines communication data rate (19.2, 38.4, or 9.6 kbps) between the Gateway and the Host through the serial interface.
Parity	None	Defines serial parity (none, even, or odd) between Gateway and Host.

### 5.7.1 Setting the Slave ID on a DX80 Gateway

By default, all Gateways are set to Modbus Slave ID 1.

To change the Slave ID on the Gateway, follow these steps.

1. Single click **button 1** to advance between menus. Stop when you reach the DVCFG menu.
2. Press **button 2** once at the \*DVCFG menu to enter the Device Configuration menu.
3. Press **button 1** to advance through the items in the \*DVCFG menu. Stop advancing when you've reached the setting for the slave ID (SLID).  
The screen is displaying (SLID).
4. Press **button 2** once to enter the slave ID (SLID) submenu.  
The screen displays the current slave ID number.
5. Press **button 1** to advance across the three digit slave ID while using the right rotary dial to select the number. To make a change, rotate the right rotary dial to zero, then to the desired number.  
As you press **button 1** to select the digit, the digit changes to reflect the position of the right rotary dial. To set the slave ID to 3, the display should read 003.
6. Press **button 2** once to save your current setting.  
The display reads SAVED.
7. Double click **button 2** to exit the \*DVCFG menu.
8. If using a Network ID (NID), adjust both rotary switches back to the NID value.  
To avoid losing the network connection between the Gateway and Nodes, reset the rotary switches back to their appropriate values before leaving the \*DVCFG sub-menus. If the Gateway and Nodes lose their connection, the network may take up to 20 seconds to re-synchronize.
9. Double-click Gateway push **button 2** to return to the Device Configuration (\*DVCFG) menu.
10. Click Gateway push **button 1** until reaching the \*RUN menu option.

### 5.7.2 Setting the Baud Rate

The baud rate establishes the communication rate between the Gateway and the host system to which it is wired.

Continuing from the previous menu position, follow these steps to set the baud rate.

1. Single-click Gateway push **button 1** to move to the next menu option, the BAUD rate.
2. Single-click Gateway push **button 2** to display the current setting. Single-click Gateway push **button 1** to cycle through the available options. Stop on the desired setting.  
The options are 9600, 19200, 38400. The factory default is 19200.
3. Single-click Gateway push **button 2** to save the new setting.
4. If using a network ID (NID), adjust both rotary switches back to the NID value.  
To avoid losing the network connection between the Gateway and Nodes, reset the rotary switches back to their appropriate values before leaving the \*DVCFG sub-menus. If the Gateway and Nodes lose their connection, the network may take up to 20 seconds to re-synchronize.
5. Double-click Gateway push **button 2** to return to the Device Configuration (\*DVCFG) menu.
6. Click Gateway push **button 1** until reaching the \*RUN menu option.

### 5.7.3 Setting Parity

Parity bits are used to detect errors in data.

Continuing from the previous menu position, follow these steps to set the parity.

1. Single-click Gateway push **button 1** to move to the next field, the PARITY field.
2. Single-click Gateway push **button 2** to display the current setting. Single-click Gateway push **button 1** to cycle through the available options. Stop on the desired setting.  
The options are NONE, EVEN, ODD. The factory default is NONE.
3. Single-click Gateway push **button 2** to save the new setting.
4. If using a network ID (NID), adjust both rotary switches back to the NID value.  
To avoid losing the network connection between the Gateway and Nodes, reset the rotary switches back to their appropriate values before leaving the \*DVCFG sub-menus. If the Gateway and Nodes lose their connection, the network may take up to 20 seconds to re-synchronize.
5. Double-click Gateway push **button 2** to return to the Device Configuration (\*DVCFG) menu.
6. Click Gateway push **button 1** until reaching the \*RUN menu option.

## 5.8 Default Output Conditions

The timeout structure of the SureCross wireless network sets relevant outputs to user-defined conditions when radio or host communications fail.

If the timeout features are enabled, the outputs are set to default states or the last known state before the error. The timeout error conditions are cleared by either a reset command sent from the host, using the front panel display, or using the auto-recover feature. Communications timeouts occur in three areas within the SureCross wireless system:

- Host Link Failure to the Gateway (Modbus Timeout)
- Gateway Link Failure with any Node
- Node Link Failure with the Gateway

### 5.8.1 Host Link Failure

A host link failure occurs when the defined timeout period, typically set to four seconds, has elapsed with no communications between the host system (or Modbus master device) and the Gateway.

The Gateway places an error code in its I/O 8 register and sends a message to all relevant Nodes within the system to set outputs to the user-defined default states. Each Node has an enable flag for a host link failure condition. If a Node's 'host link failure' flag is not set, the outputs on the Node are not affected.

In the example shown, a host link failure between the host system and Gateway result in the outputs of Node 1 and Node 2 sent to the defined conditions if both Nodes have the host link failure checkbox selected.

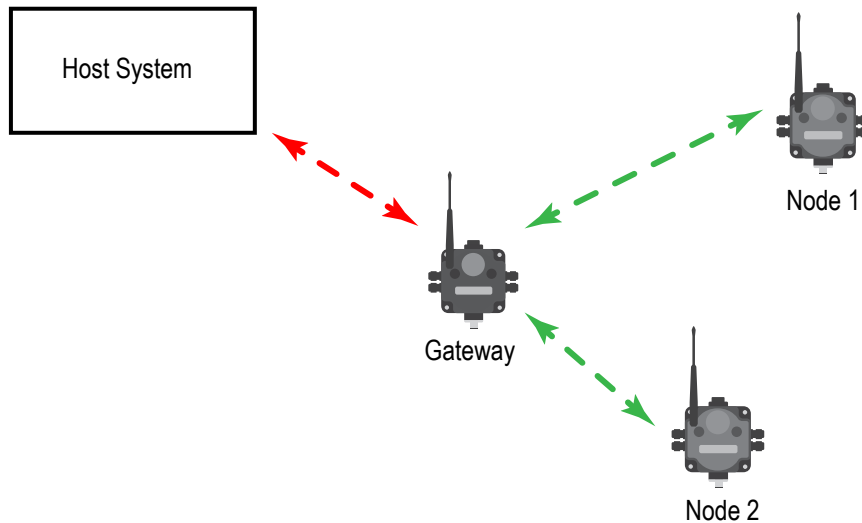

### 5.8.2 Gateway Link Failure

Gateway link failures are determined by three global parameters: polling interval, maximum missed message count, and re-link count.

The polling interval (or rate) defines how often the Gateway communicates with each Node to verify the radio link is operating. The Gateway increments a Node's missed message count if a Node does not immediately report back from a polling request. If a Node's missed message count exceeds the maximum missed message count, the Gateway generates a timeout error in the Modbus I/O 8 register of the appropriate Node.

The auto-recover feature uses the re-link count parameter. If enabled, the error condition heals itself if the Gateway and Node have successfully exchanged N-number of good polling messages. The N-number is the re-link count, or the number of messages required to re-establish a radio link.

When the Node's Gateway Link Failure flag is set and the Gateway determines a timeout condition exists for a Node, any outputs linked from the failing Node are set to the user-defined default state. Each Node has a Gateway Link Failure flag that can be set or cleared depending on the particular application.

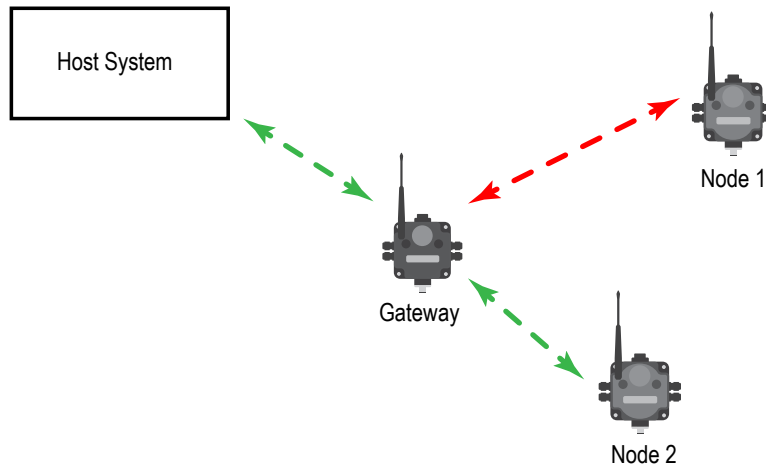

In the sample system shown, the communication link between the Gateway and Node 1 has failed. Node 2 must have its Gateway Link Failure flag set to allow any outputs linked to Node 1 to be set to the defined default state when the communication link between Node 1 and the Gateway fails.

### 5.8.3 Node Link Failure

A Node Link Failure is determined by the polling interval/rate or the out-of-sync timing.

When a Node detects a communications failure with the Gateway and the Node Link Failure flag is set, the output points are set to the user-defined states and the inputs are frozen. When output points are set to their default states because of an error condition, only the Gateway can clear the error condition and resume normal operation. The front panel buttons or the Gateway's register I/O 15 clear error conditions.

Clearing a lost radio link error does not restore communications. Banner recommends determining and resolving the cause of the radio link error, then allowing the system to auto-recover the lost communications.

**Polling Interval.** The global polling interval defines the time interval during which the Node should expect a polling request from the Gateway.

**Out of Sync.** An out of sync condition is met when a Node fails to receive the Gateway's beacon within a factory-set time period, about 10 seconds. Both the out of sync and polling interval conditions are used to detect a failure because the Node can remain in sync with the Gateway but be unable to transmit data. If the Gateway drops out of the network, the Nodes detects the out of sync condition long before the polling interval expires.

## 5.9 Defining the Units

The units parameter defines the range and/or type of data value associated with an input or output.

Selecting Units from within any configuration tool changes the units definition of several parameters, including threshold, hysteresis, and delta. For example, if the units are 0 to 20 mA, the threshold, hysteresis, and delta values are entered as milliampere values. Selecting Temp °C changes the threshold, hysteresis, and delta units to degrees Celsius.

Signed values range from -32768 to +32767 and allow for the measurement of negative values. Signed values are typically used for measuring temperatures. Signed values are stored as two's complement values.

Unsigned values range from 0 to 65535 and are used to measure values that do not go below zero, such as 4 to 20 mA, distance, or a counter.

### 5.9.1 Interpreting Register Values in the Banner Wireless System

The units conversion table defines the type and range of values for each type of I/O.

The wireless devices have many different units of measure for inputs including: milliamp (mA), voltage (V), temperature (°C or °F), humidity (RH), or a raw 16-bit or 32-bit value. Outputs can be either current (4 to 20 mA, 0 to 20 mA) or voltage (0 to 10 V dc). All values stored in Modbus registers are unsigned numbers, except for temperature readings. The temperature readings are stored as signed numbers (two's complement).

The following table defines the range of values and descriptions for input units.

Input Type	I/O Range		Holding Register Representation		Data Conversion	Description
	Min.	Max.	Min.	Max.		
Discrete	0	1	0	1	-	-
0 to 20 mA	0.0 mA	20.0 mA	0	65535	$(20 \text{ mA} \div 65535) \times \text{Reg Value} = \text{mA}$	Linear mapping of unsigned register value to current
4 to 20 mA	4.0 mA	20.0 mA	0	65535	$((16 \text{ mA} \div 65535) \times \text{Reg Value}) + 4 = \text{mA}$	Linear mapping of unsigned register value to current
0 to 10 V dc	0.0 V dc	10.0 V dc	0	65535	$(10 \text{ V} \div 65535) \times \text{Reg Value} = \text{V}$	Linear mapping of unsigned register value to voltage
Temp C/F (high resolution)	-1638.3	+1638.4	0	65535	$(\text{Converted Reg Value}) \div 20 = \text{Temp}$	Signed Values
Counter	0	65535	0	65535	-	-
16-bit T30UF	0 mm	65535 mm	0	65535	None; stored as millimeter value	Unsigned
Humidity	0% RH	100% RH	0	10000	$(\text{Reg Value}) \div 100 = \text{Relative Humidity (RH)}$	Unsigned

Temperature Measurements:

- In high resolution mode, the temperature = (Modbus register value) ÷ 20. For high resolution temperature input, 0 in the register is interpreted as 0° and 65535 in the register (0xFFFF) is interpreted as -1 ÷ 20 = -0.05°.
- In low resolution mode, the temperature is (Modbus register value) ÷ 2. For low resolution temperature input, 0 in the register is interpreted as 0° and 65535 in the register (0xFFFF) is interpreted as -1 ÷ 2 = -0.5°. The I/O range values are -16383 through 16384.

When using a 4 to 20 mA sensor with a 0 to 20 mA input, the sensor uses the 4 to 20 mA section of the total range. Using a 4 to 20 mA with a 0 to 20 mA input allows you to determine when you have an error condition with the sensor. A normal input reading between 4 and 20 mA indicates a functioning sensor whereas a value below 4 mA indicates an error condition, such as a broken wire or loose connection. Some Sure Cross devices allow you to configure the analog inputs and outputs to use either 0 to 20 mA or 4 to 20 mA.

## 5.10 Setting up the Wireless Network Using the Rotary Dials

Follow these steps to set up your wireless network using the rotary dials instead of using extended addressing mode. Banner recommends using Extended Addressing Mode, but some older products may only recognize Rotary Dial Address Mode.

### 5.10.1 Rotary Dial Address Mode

Rotary dial address mode uses the left dial to set the Network ID and the right dial to set the Device Address (device ID). The wireless RF network is defined by the Network ID (NID) assigned to the Gateway and its Nodes. Each device within this common network must have a unique Device Address assigned.

For factory configured kits, the Network ID and Device Addresses have been assigned. Otherwise, use the rotary dials (shown below) to define both the NID and Device Address for each device.

To operate more than 15 Nodes in your wireless network, use Extended Address Mode and device binding instead of Rotary Dial Address Mode.

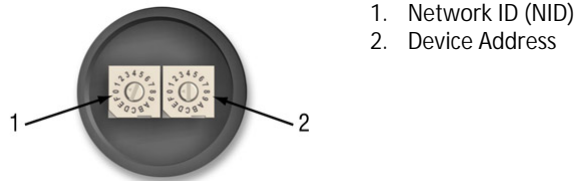

### 5.10.2 Setting the Network ID Using the Rotary Dials

The wireless network is defined by the Network ID (NID) assigned to the Gateway and its Nodes.

Each device within this common network must have a unique Device Address assigned. When using Rotary Dial Address Mode, set the Network ID on the Gateway and all its Nodes using the left rotary dial.

1. Remove rotary dial access covers. Turn counterclockwise to remove and clockwise to tighten.
2. On the Gateway, set the left rotary dial to 1. The factory default NID setting on all devices is 1.
3. On all Nodes within the same network, set the left rotary dial to 1. Assign the same NID to all devices within a single network (hexadecimal 0-F).

When more than one network is operating in the same space, assign a unique Network ID to each network.

### 5.10.3 Setting the Device Address Using the Rotary Dials

The Device ID establishes a unique identifier for each device within a wireless network.

1. On the Gateway, set the right rotary dial to 0.  
A device address of 0 on the Gateway displays settings for the Gateway itself. To view settings for another device on the network, adjust the right rotary dial on the Gateway to the desired device address.
2. On the first Node (device address = 1), set the right rotary dial to 1. Do not change the Device ID for pre-configured kits as this would affect the factory mapping of the I/O.
3. On the second Node (device address = 2), set the right rotary dial to 2.
4. Continue setting the device address for each additional Node using a unique number (...3,4,5).

After setting both the Network ID and Device Address for all devices, re-install the rotary dial access covers, referring to the Installation section for IP67 instructions. A successful radio link is identified by a blinking green LED 1 on each Node.

### 5.10.4 Setting Up Channel Search Mode

A Gateway runs Channel Search Mode on power up or when the Gateway's Network ID is changed.

Before beginning, apply power to the Gateway.

After Channel Search Mode begins, the Gateway determines if its assigned Network ID is available for use or is already in use by another radio network. For example, if a Gateway powers up set to Network ID 2, Channel Search Mode begins running as shown below.

1. Apply power to the Gateway and set the rotary dial to a Network ID number (shown here as Network ID 2).  
Channel Search Mode begins running, and LED 1 is solid red and LED 2 is flashing amber. The LCD displays START CHANNEL SEARCH MODE. The test takes one minute to complete and counts down from 60 seconds. The LCD shows SEARCH NID 2 1M 0S. If the Network ID is not already in use, the LCD displays NID OK and enters RUN mode.
2. If the Network ID is already in use by another DX80 Gateway device, an IN USE message displays. Use the left rotary dial to select another ID.
3. After selecting a new Network ID, click button two once to restart Channel Search Mode.  
The screen cycles between displaying the current Network ID setting and a new NID setting until either the left rotary dial is changed to another Network ID or the test is aborted. (LED 1 is solid red and LED 2 flashes red.) Once a new Network ID is selected, Channel Search Mode begins again.
4. After entering RUN mode, the LCD display shows the current I/O status of the Gateway.  
The Gateway and GatewayPro start in \*RUN mode. The LCD shows the current Network ID (NID), identifies the device, then begins cycling through the I/O points (GatewayPro has no I/O points).

To cancel Channel Search Mode, double-click button two. The word ABORT displays on the LCD and both LEDs are solid red. The Gateway enters RUN mode, operating on the Network ID chosen.

To ignore the Channel Search Mode results and use a Network ID that Channel Search Mode determined was in use, double-click button two. The word IGNORE displays on the LCD and both LEDs are solid red. The Gateway enters RUN mode, operating on the Network ID chosen despite being in use by another device.

#### Channel Search Mode Flowchart

The example shown below is testing Network ID 2.

The LCD displays the text shown. While Channel Search Mode runs, LED 1 is solid red and LED 2 flashes yellow.

The device tests Network ID 2 for availability and counts down from one minute, zero seconds.

The selected Network ID is available for use. LED 1 is solid red, LED 2 is solid yellow.

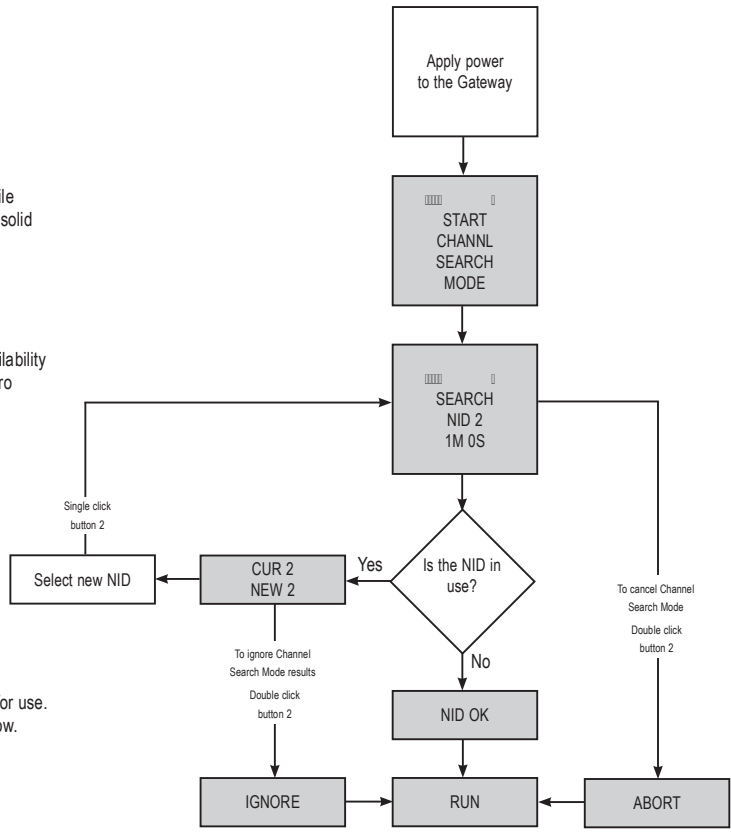



# 6 System Layouts

Because of the flexibility of the DX80 wireless devices, many different configurations using Gateways, Nodes, GatewayPros, Ethernet Bridges, Modbus slave devices, data radios, data radio repeaters, and/or solar powered systems are possible, both as stand-alone systems and host-connected systems.



DX83 Ethernet Bridge



DX80 Gateway, 900 MHz



DX80DR9M-H MultiHop Radio

## 6.1 Stand-Alone Systems

### 6.1.1 Mapped Pairs (DX70)

In this system, a DX70 pair is used to map I/O in a simple one-to-one configuration. Inputs on one DX70 are mapped to the outputs of the other device. DX70 kits are configured at the factory and require no additional configuration by the user.

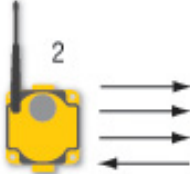
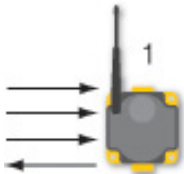

Item	Model No.	Description
1	DX70G...	DX70 Gateway
2	DX70N...	DX70 Node

### 6.1.2 Gateway with **Multiple** Nodes (DX80)

In this configuration, the Gateway is the master of the wireless network.

Configure this network using the User Configuration Tool (UCT) and RS-485 to USB adapter cable. The UCT is used to map inputs and outputs between Nodes and Gateways.

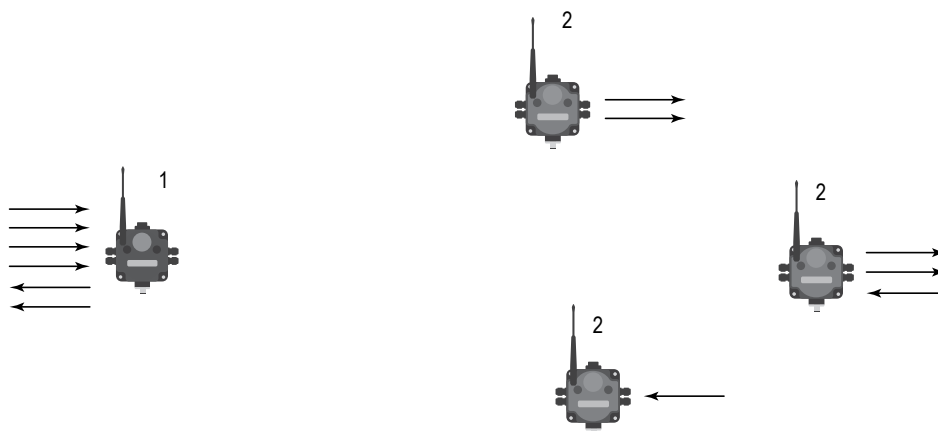

Item	Model No.	Description
1	DX80G...	DX80 or DX80 Performance Gateway
2	DX80N...	DX80 or DX80 Performance Node
	81398	User Configuration Tool (free to download from the <a href="#">Wireless Products</a> section of Banner Engineering's website)
	BWA-HW-006	RS-485 to USB adapter cable (not shown)

### 6.1.3 Gateway **Configured** as a Modbus Master

This example network uses the Gateway as master of the wireless network and master of the Modbus network. This configuration is used when the I/O capacity of the Gateway is exceeded.

The Gateway is configured with a table of mapping entries that allow the DX85 Modbus RTU Remote I/O devices (as Modbus slaves) to be mapped to the wireless Nodes. The DX85 devices add additional I/O points to the network through hard-wired fieldbus connections on the Gateway side.

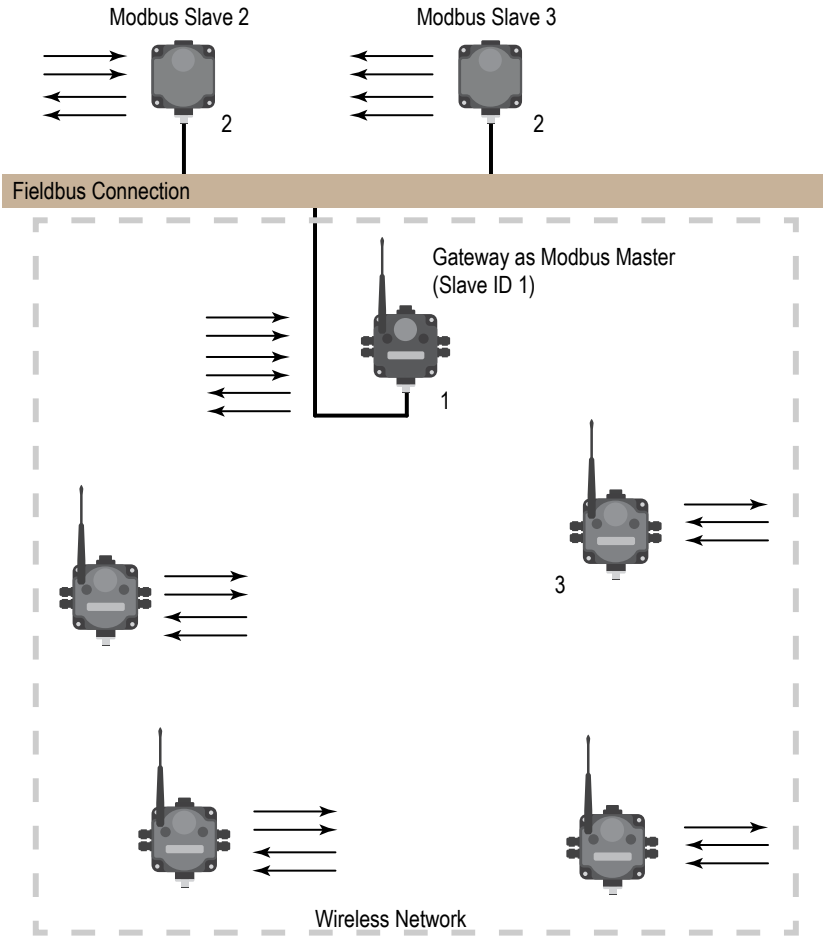

Item	Model No.	Description
1	DX80G...	DX80 or DX80 Performance Gateway
2	DX85M...	DX85 Modbus RTU Remote I/O
3	DX80N...	DX80 or DX80 Performance Nodes or FlexPower Nodes
	81398	User Configuration Tool (free to download from the <a href="#">Wireless Products</a> section of Banner Engineering's website)
	BWA-HW-006	RS-485 to USB adapter cable (not shown)

## 6.2 Modbus RTU

### 6.2.1 Modbus RTU Host Controlled **Operation**

A simple host-connected system uses an RS-485 serial cable to connect the Gateway to a host system.

The host system may be a PC or a PLC unit. Because the serial cable is used to connect to a host system, the communications protocol used is Modbus RTU. The wireless network is a Modbus slave. In this configuration, the wireless network collects I/O data and sends it back to a Modbus host system.

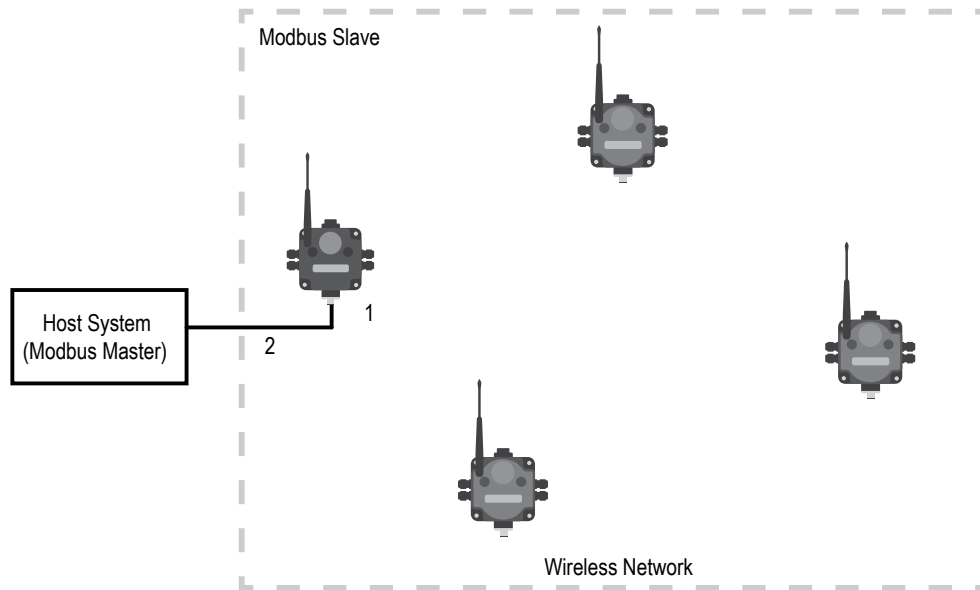

Item	Model No.	Description
1	DX80G...	DX80 or DX80 Performance Gateway
2	CSRB-M1250M125.47M125.73	Cable, RS-485, quick disconnect 5-pin Euro, male trunk, female branches, black
	MQDC1-5***	Cable, RS-485, quick disconnect 5-pin Euro, female single end, lengths vary (not shown)

### 6.2.2 Modbus RTU with **Multiple** Slave Devices

In the example host controlled configuration, the Gateway is a Modbus slave to the host system, but remains the master of the wireless network.

The Gateway is connected directly to the host system using an RS-485 serial cable. This system may also connect DX85 Modbus RTU Remote I/O devices to the serial cable to expand the available I/O. The Gateway and each DX85 connected as shown below are Modbus slave devices to the host system.

Purpose: This wireless network also collects I/O data and sends it back to a Modbus host system, but adds local wired I/O points.

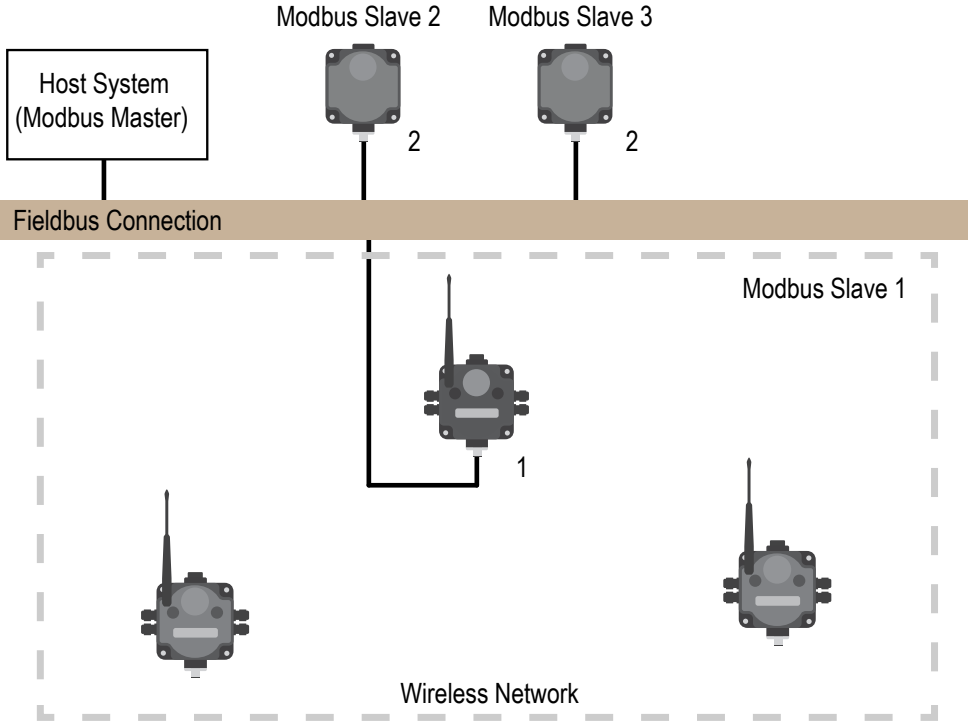

Item	Model No.	Description
1	DX80G...	DX80 or DX80 Performance Gateway
2	DX85M...	DX85 Modbus RTU Remote I/O
3	MQDC1-5***	Cable, RS-485, quick disconnect 5-pin Euro, female single end, lengths vary (not shown)

### 6.2.3 Modbus RTU with **Multiple** Slave Devices - Layout 2

In this example host controlled configuration, the Gateway is a Modbus slave to the host system, but remains the master of the wireless network.

The Gateway is connected directly to the host system using a fieldbus connection. This system also connects DX85 Modbus RTU Remote I/O devices and a third-party Modbus slave device to the serial bus to expand the available I/O. The Gateway and each DX85 connected as shown below are Modbus slave devices to the host system.

Purpose: This wireless network collects I/O data and sends it back to a Modbus host system, but adds local wired I/O points and expands the network using a fieldbus connection.

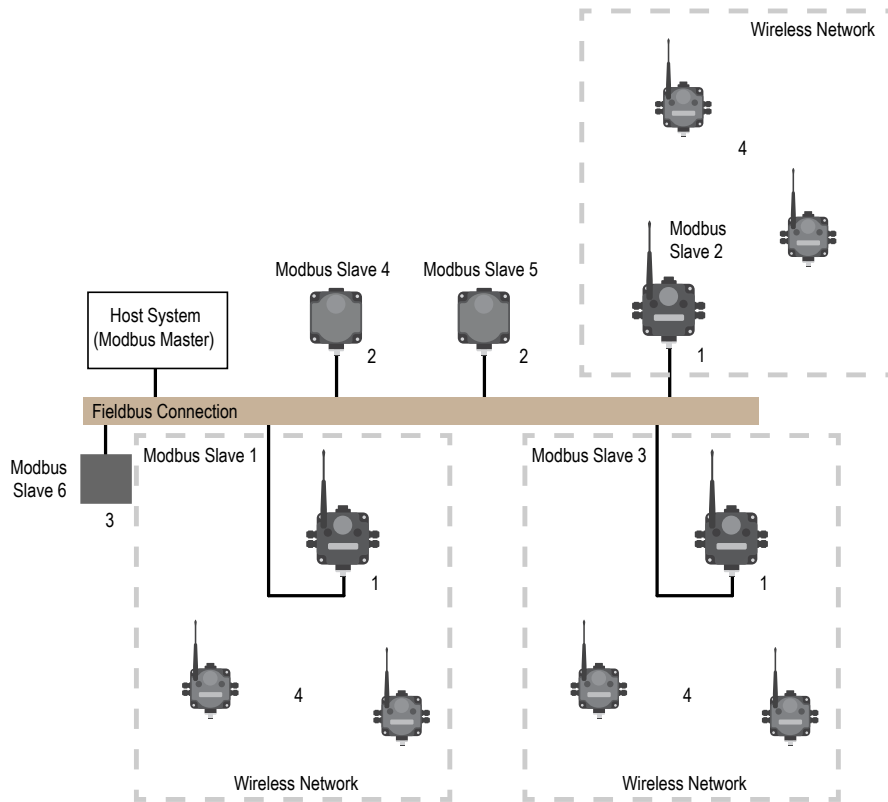

Item	Model No.	Description
1	DX80G...	DX80 or DX80 Performance Gateway
2	DX85M...	DX85 Modbus RTU Remote I/O
3		Third party Modbus slave device
4	DX80N...	DX80 or DX80 Performance Nodes or FlexPower Nodes

### 6.3 Modbus/TCP and EtherNet/IP

#### 6.3.1 Host Connected - DX80 GatewayPro

Connect a GatewayPro to a host system using the GatewayPro's industrial Ethernet connection.

To connect the GatewayPro directly to the host system, use a crossover cable. By default, the GatewayPro is a Modbus/TCP or EtherNet/IP™ server. To configure the GatewayPro as a Modbus client device, use the configuration Web pages.

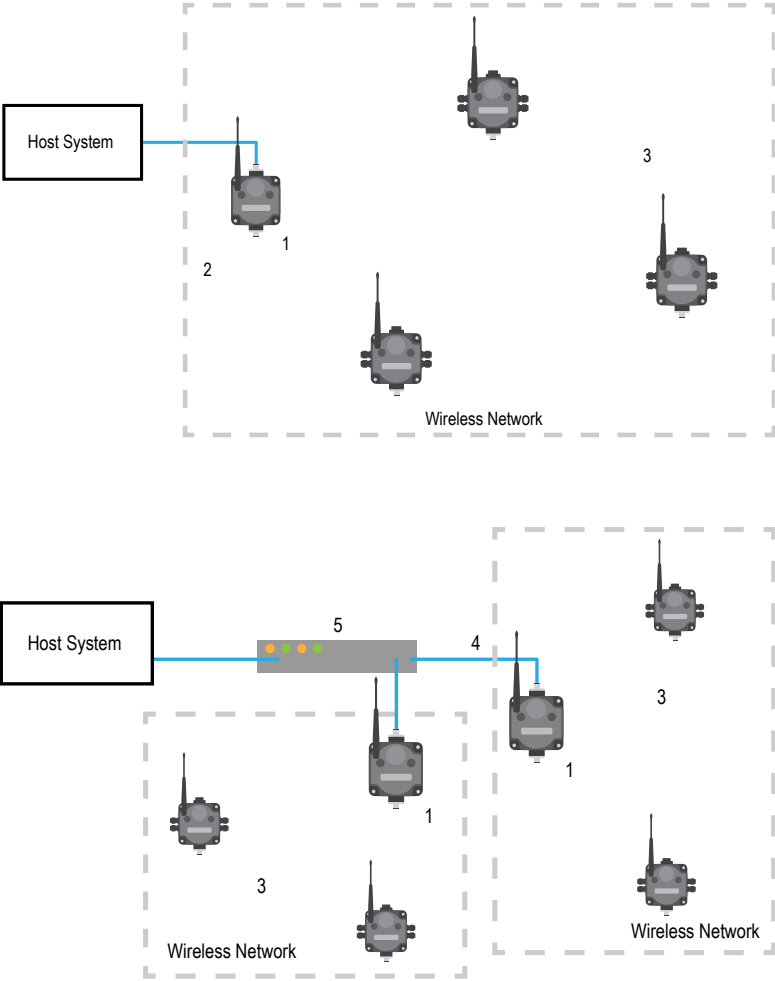

Item	Model No.	Description
1	DX80P**6S	DX80 or DX80 Performance GatewayPro, Protocol converter or Advanced Config models
2	BWA-EX2M	Ethernet Cable, M12 Industrial/RJ45, Crossover, 2 m (using Modbus/TCP or EtherNet/IP)
3	DX80N...	DX80 or DX80 Performance Nodes or FlexPower Nodes
4	BWA-E2M	Ethernet Cable, M12 Industrial/RJ45, Straight, 2 m
5		Ethernet hub or switch box

## 6.4 Data Radios

### 6.4.1 Data Radios

Data radios extend the range of the Modbus network and keep the network addressing system simple. In this basic example, the data radios act as a wire replacement to extend the Modbus network.

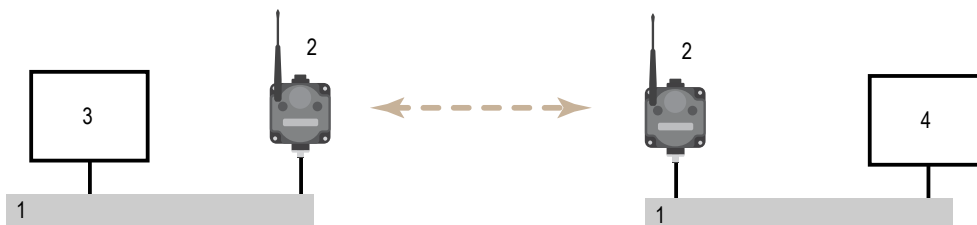

1. Fieldbus connection
2. Data radio
3. Modbus master device
4. Modbus slave device

### 6.4.2 Data Radios with DX85 Modbus RTU Remote I/O Devices

In this example network, DX85 Extended Remote I/O devices are wired to the data radios and act as Modbus master or slave devices. The data radios extend the range of the Modbus network.

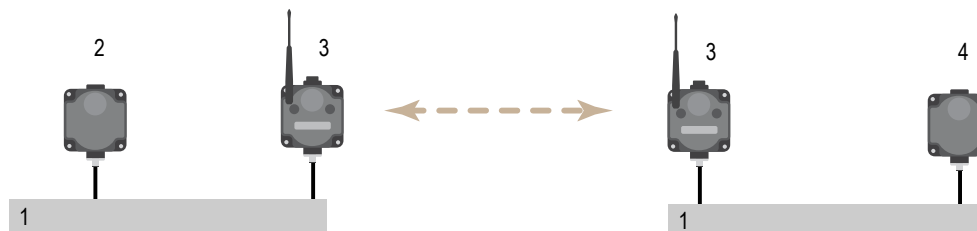

1. Fieldbus connection
2. DX85 as Modbus master
3. Data radio
4. DX85 as Modbus slave



### 6.4.3 Data Radios with a Gateway as the Modbus Master

In this example network, the Gateway is both the master for the radio network and the master for the Modbus network. The DX85 shown is a Modbus slave; the data radios extend the range of the Modbus network.

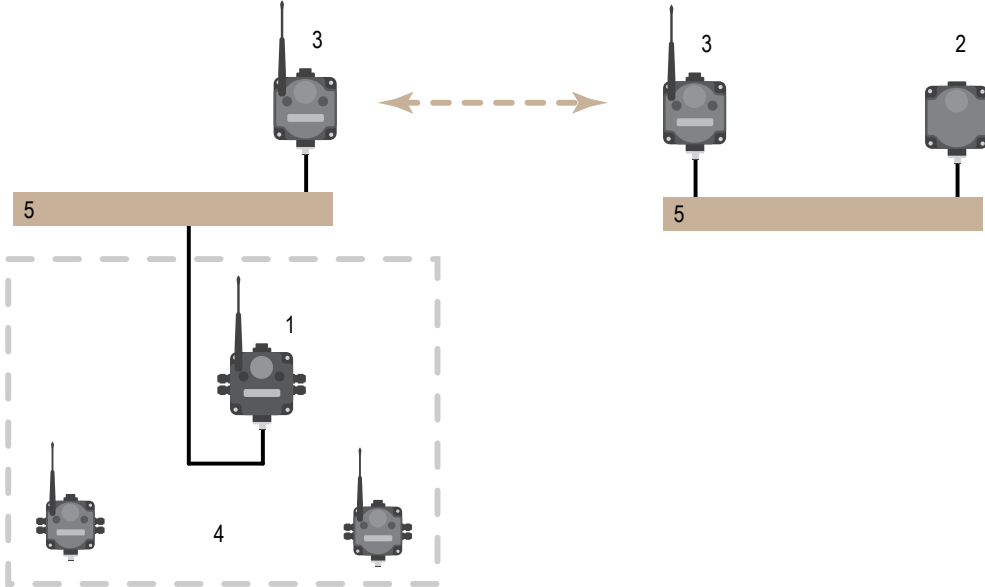

Item	Model No.	Description
1	DX80G...	DX80 or DX80 Performance Gateway (configured as a Modbus master for this example)
2	DX85M...	DX85 Modbus RTU Remote I/O (configured as a Modbus slave for this example)
3	DX80DR*M-H	MultiHop Data Radio
4	DX80N...	DX80 or DX80 Performance Nodes or FlexPower Nodes
5		Fieldbus connection

## 7 Sensor Connections

The Sensor Connections guide lists most common Banner and non-Banner sensors and how to wire them to the DX80 devices.

This reference guide lists typical connections. If you have additional questions about a specific sensor or its connection instructions, please contact Banner Engineering or the manufacturer of the sensor you are using.

**Discrete Sensors.** Neither the inputs nor the outputs on the DX80 devices are isolated. Under certain operating conditions, externally powered sensors may need to have ground in common with the DX80 device to which they are connected. The power sources do not have to be the same.

**Analog Sensors.** For analog sensors, the ground/dc common of the sensor should be connected to the ground of the DX80 device. For best results, Banner recommends that the power source for the sensor and DX80 device is the same.

### 7.1 Discrete Inputs

**Discrete Sensors.** Neither the inputs nor the outputs on the DX80 devices are isolated. Under certain operating conditions, externally powered sensors may need to have ground in common with the DX80 device to which they are connected. The power sources do not have to be the same.

#### 7.1.1 Discrete Inputs, Sourcing

##### Two-Wire Sensors

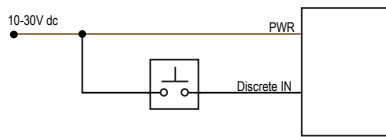

Wiring diagram for a sourcing (PNP), two-wire sensor powered using the SureCross device terminal block.

The sensor's power source might need to be the same as the SureCross device power source.

##### Three-Wire Sensors

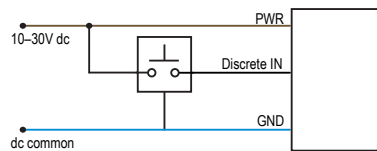

Wiring diagram for a sourcing (PNP), three-wire sensor powered using the SureCross device terminal block. Under certain conditions, the dc commons between the sensor and the SureCross device might need to be connected.

The sensor's power source might need to be the same as the SureCross device power source.

#### 7.1.2 Discrete Inputs, Sinking

##### Two-Wire Sensors

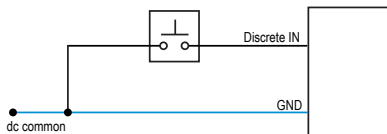

Wiring diagram for a sinking (NPN) two-wire sensor powered using the SureCross device terminal block. Under certain conditions, the dc commons between the sensor and the SureCross device might need to be connected.

##### Three-Wire Sensors

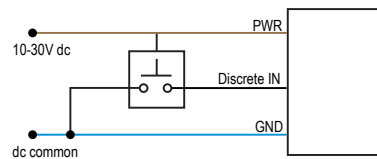

Wiring diagram for a sinking (NPN) three-wire sensor powered using the SureCross device terminal block. Under certain conditions, the dc commons between the sensor and the SureCross device might need to be connected.

#### 7.1.3 Discrete Inputs, MINI-BEAM

##### MINI-BEAM

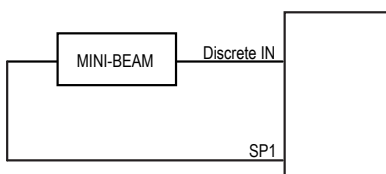

MINI-BEAM

Two-wire MINI-BEAM sensor using a FlexPower Node and powered using the Node's switch power.

7.2 Discrete Outputs

7.2.1 Discrete Outputs

Sourcing (PNP)

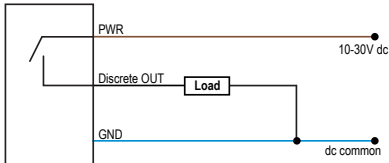

Wiring diagram for a sourcing (PNP) two-wire output load powered using the SureCross device terminal block. Under certain conditions, the dc commons between the load and the SureCross device might need to be connected.

Sinking (NPN)

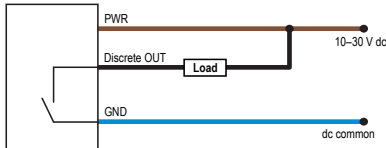

Wiring diagram for a sinking (NPN) two-wire output. Under certain conditions, the dc commons between the load and the SureCross device might need to be connected.

The sensor's power source might need to be the same as the SureCross device power source.

7.3 Analog Inputs

Analog Sensors. For analog sensors, the ground/dc common of the sensor should be connected to the ground of the DX80 device. For best results, Banner recommends that the power source for the sensor and DX80 device is the same.

7.3.1 Analog Inputs, Powered using SureCross Device Terminals

Two-Wire Sensors

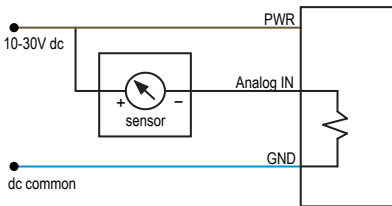

Two-wire analog sensor powered from a 10–30V dc power SureCross device using the PWR terminal.

Do not exceed analog input ratings for analog inputs. Only connect sensor outputs to analog inputs.

Three-Wire Sensors

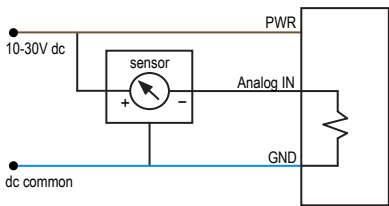

Three-wire analog sensor powered from 10–30V dc power SureCross device using the PWR terminal.

Do not exceed analog input ratings for analog inputs. Only connect sensor outputs to analog inputs.

7.3.2 Analog Inputs, Powered from Switch Power

Two-Wire Sensors

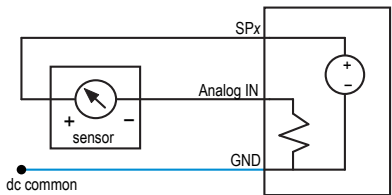

Three-Wire Sensors

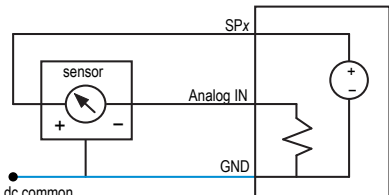

Two-Wire Sensors

Two-wire analog sensor or two-wire NAMUR proximity sensor using a FlexPower Node and powered using the Node's switch power.

Do not exceed analog input ratings for analog inputs. Only connect sensor outputs to analog inputs.

Three-Wire Sensors

Three-wire analog sensor using a FlexPower Node and powered using the Node's switch power.

Do not exceed analog input ratings for analog inputs. Only connect sensor outputs to analog inputs.

7.3.3 Analog Inputs, Powered Externally

Do not exceed analog input ratings for analog inputs. Only connect sensor outputs to analog inputs.

Two-Wire Sensors

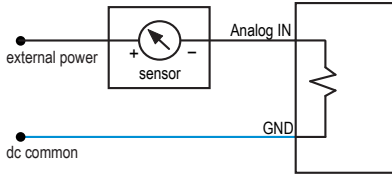

Two-wire analog sensor using a FlexPower Node but the sensor is powered externally (not from the SureCross device).

Three-Wire Sensors

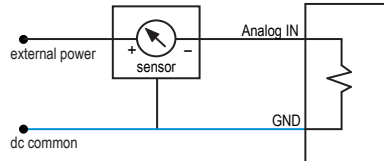

Three-wire analog sensor using a FlexPower Node but the sensor is powered externally (not from the SureCross device).

7.3.4 Analog Inputs, Temperature Sensors

Thermocouple

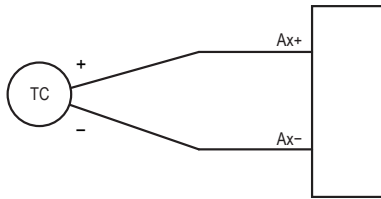

TC Type	- Wire	+ Wire
J	red	white
K	red	yellow
R	red	black

RTD

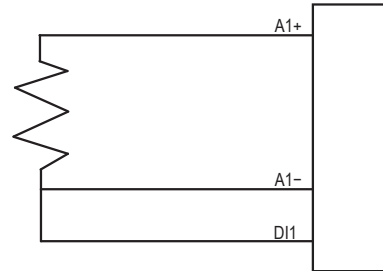

This wiring diagram applies to a standard three-wire RTD sensor. When using thermocouple and RTD sensors, the quality of the power supply influences the accuracy of the signal.

7.3.5 Analog Inputs, QT50U Long-Range Ultrasonic Sensor

QT50U Ultrasonic Sensor

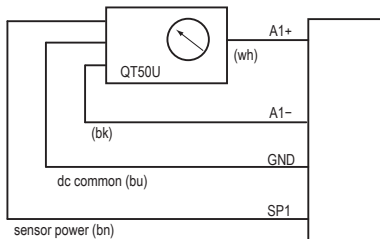

Four-wire QT50U sensor, using a FlexPower Node, and powered using the Node's switch power terminal. The QT50U output is set to 4–20 mA.

Do not apply power to the Ax+ connection.

## 7.4 Analog Outputs

### 7.4.1 Analog Outputs, Three-Wire Sensors

Powered from the SureCross Terminals | Powered Externally

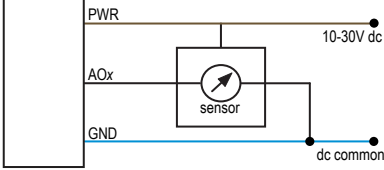

Three-wire analog output device powered by the SureCross device.

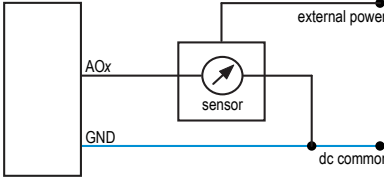

Three-wire analog output device powered externally (not from the SureCross device).

### 7.4.2 Analog Outputs, Drive Motor Controllers

AI- Referenced to Ground | AI- Not Referenced to Ground

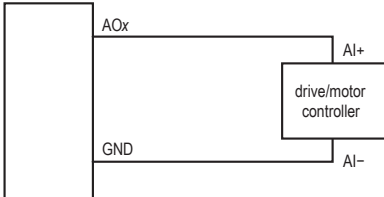

When the AI- can be referenced to ground, use this wiring diagram for drive/motor controllers.

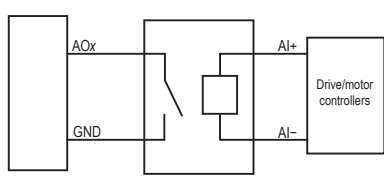

When the AI- cannot be referenced to ground, use this wiring diagram for drive/motor controllers.

## 8 Sure Cross® Power Solutions

The Sure Cross Power Solutions guide lists the various power options for Sure Cross devices. Also included in this guide is a battery life calculation for some discrete and analog sensors and brief instructions explaining how to measure your sensor's current draw and calculate the estimated battery life for your installation.

### 8.1 Using 10 to 30 V dc Power

For locations with power, the 10 to 30 V dc devices offer an easy-to-install solution for sensing devices.

- 10 to 30 V dc can power more sensors and more types of sensors to obtain the necessary data.
- The number of sensors powered by the Sure Cross device is only limited by the number of I/O points available.
- The Node may be set to high-speed I/O sample and reporting rates for quicker data collection.

### 8.2 What is FlexPower®?

Banner's FlexPower technology supplies a true wireless solution by allowing the device to operate using either 10 to 30 V dc, 3.6 V lithium D cell batteries, or solar power. This unique power management system can operate a FlexPower Node and an optimized sensing device for up to five years on a single lithium D cell.

- FlexPower Nodes may be powered from 10 to 30 V dc and use an external battery supply module to provide a battery back-up solution.
- When a FlexPower Node receives 10 to 30 V dc, it operates like a standard 10 to 30 V dc Node.
- Good applications for FlexPower devices operating from batteries include sensors that require no or very little power, including dry contacts, RTDs, and thermocouples.

The following FlexPower options are available:

- DX81-LITH, a single battery supply module;
- DX81P6, a 6-pack of lithium batteries;
- DX81H, a single battery supply module designed specifically to power the DX99 Intrinsically Safe devices with polycarbonate housings; and
- BWA-SOLAR PANEL 3W, 5W, or 20W, solar panel assemblies.



DX81-LITH: Single battery supply module



DX81P6: Six-pack battery supply module



BWA-SOLAR PANEL 3W, BWA-SOLAR PANEL 5W, or BWA-SOLAR PANEL 20W: Includes 3 W, 5 W, or 20 W solar panel; order the controller separately when you are not using the solar panel with a DXM Wireless Controller. For more information about solar power solutions, see *Sure Cross® Solar Solutions*.

DX81H: Single battery supply module designed specifically to power the DX99 Intrinsically Safe devices with polycarbonate housings

#### 8.2.1 Switch Power

Efficient power management technology enables some FlexPower devices to include an internal power supply, called switch power (SP), that briefly steps up to power sensors requiring 5, 10, or 15 V power (e.g. 4 to 20 mA loop-powered sensors). When the switch power output cycles on, the voltage is stepped up to power the sensor for a specific time. The warmup time denotes how long the sensor must be powered before a reliable reading can be taken. After the warmup time has passed, the input reads the sensor, then the switch power shuts off to prolong battery life. The switch power voltage, warm-up time, and sample interval are configurable parameters.

- To reduce power consumption and extend battery life, use slower sample and reporting rates. Faster sample and report rates can be configured, but decrease battery life. For details, refer to the DIP switch configurable parameters for your device.
- The FlexPower switched power management system can operate a FlexPower Node and most sensing devices for up to five years on a single lithium D cell.

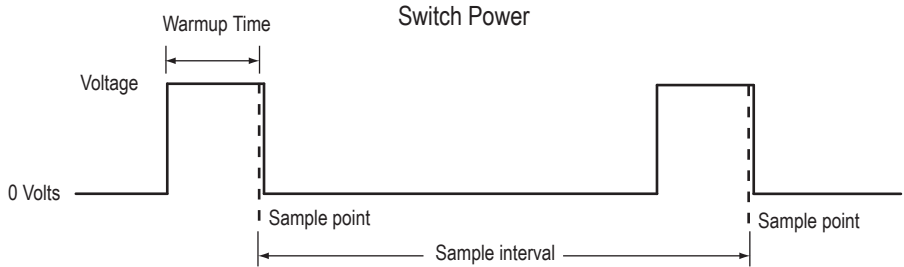

### 8.2.2 FlexPower with Integrated **Battery**

Some FlexPower devices operate using a **battery** integrated into the housing.

These devices powered by integrated **batteries**:

- Operate only from the **battery** and cannot use an external power supply, and
- Are limited in the available I/O because of the limited connectivity.

## 8.3 **Battery** Life Calculations

### 8.3.1 **Battery** Life for Some Analog Sensors

The **battery** life calculations, in years, for some analog sensors are shown in the table below.

Table 1: *Battery Life in Years*

	Manufacturer	Device	Model	Boost Voltage	Warmup Time
1	Banner	U-Sonic/Distance	QT50ULBQ6-75390	15 V	500 ms
2	Esterlink/KPSI	Submersible Level	KPSI Series 700	10 V	10 ms
3	Turck	Pressure	PT100R-11-L13-H1131	10 V	10 ms

Sample and Report Rates							
	1 second	2 seconds	4 seconds	16 seconds	64 seconds	5 minutes	15 minutes
1	0.00	0.00	0.00	0.26	0.91	2.61	4.45
2	0.87	1.45	2.15	3.32	3.89	4.25	4.25
3	0.87	1.45	2.15	3.32	3.89	4.25	4.25

Note, **battery** life calculations are based on the sensor operating 24 hours a day, 365 days a year.

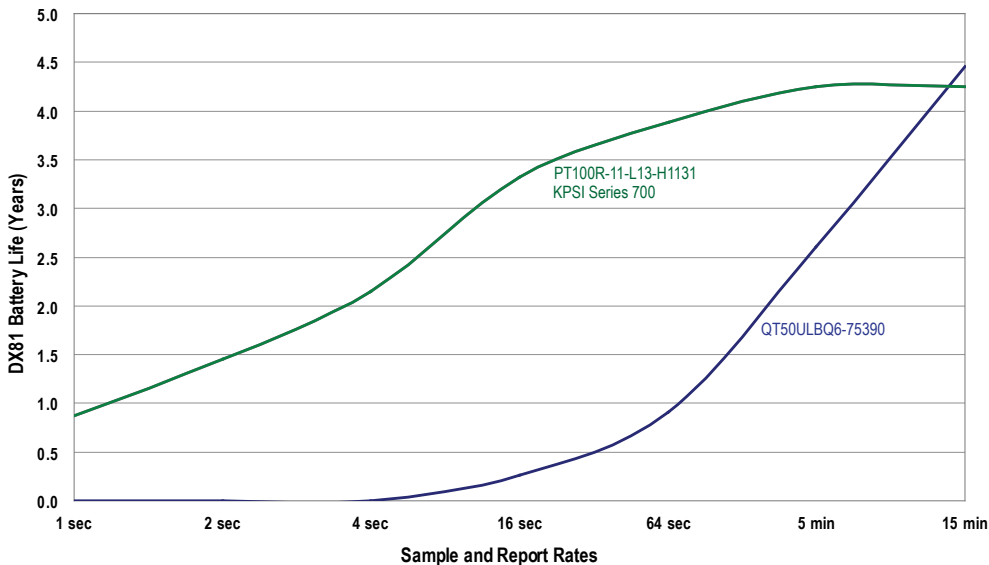

For each sensor characterized, a boost voltage and warmup time was specified. The sample and reports rates were varied to calculate the estimated battery life. For example, a Banner QT50ULBQ6-75390 sensor set to a boost voltage of 15 volts, a warm-up time of 500 milliseconds, and a sample and report rate of 15 minutes, should have a battery life of 4.45 years.

All battery life calculations are approximations based on a strong radio signal. Weaker radio connections and missed packets will decrease the battery life.

### 8.3.2 Discrete Configuration

The battery life calculations, in years, for some discrete sensors are shown in the table below.

Table 2: Battery Life in Years

	Manufacturer	Device	Model	Boost Voltage	Warmup Time
1	Banner	Optical	SM312DQD-78419	5 V	4 ms
2	Turck	Inductive Proximity	Bi10U-M30-AP6X-H1141	10 V	10 ms

Sample and Report Rates							
	62.5 ms	125 ms	250 ms	500 ms	1 second	2 seconds	16 seconds
1	0.97	1.67	2.62	3.74	4.75	5.49	6.28
2	0.20	0.40	0.72	1.27	2.05	2.99	5.07

Note, battery life calculations are based on the sensor operating 24 hours a day, 365 days a year.

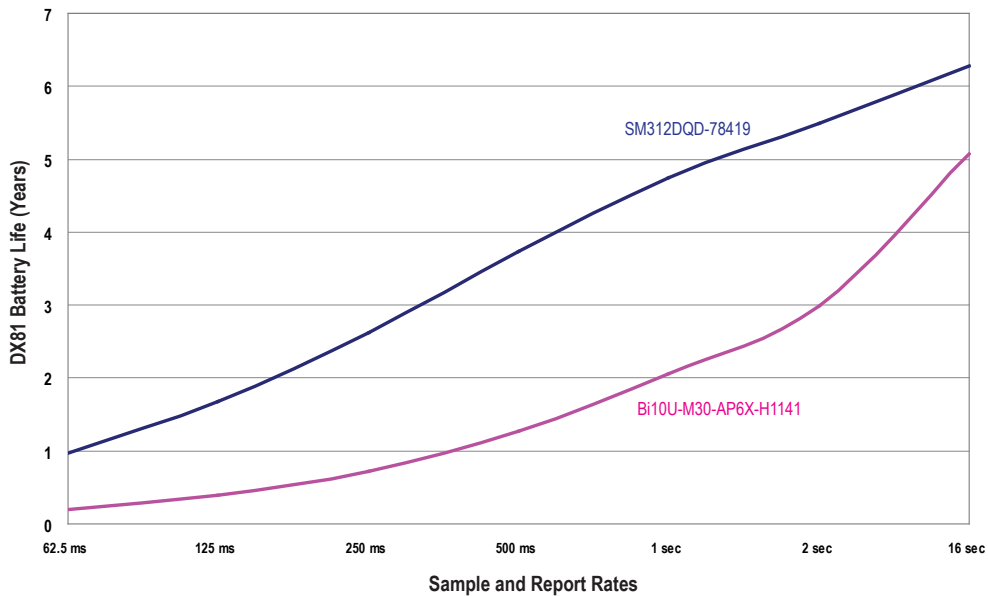

For each sensor characterized, a boost voltage and warmup time was specified. The sample and reports rates were varied to calculate the estimated battery life. For example, a Banner Optical sensor, model SM312DQD-78419, set to a boost voltage of 5 volts, a warm-up time of 4 milliseconds, and a sample and report rate of 16 seconds, should have a battery life of just over 6 years.

The curves for discrete devices represent a “worst case” as far as battery use because we are assuming for each sample of the sensor’s output a change in state has occurred (e.g., target present to target absent or vice versa), sending a radio message from Node to Gateway. No messaging occurs unless there is a change to report. Actual battery life depends on how many state changes actually occur.

All battery life calculations are approximations based on a strong radio signal. Weaker radio connections and missed packets will decrease the battery life.

### 8.3.3 Battery Life of Temperature and Humidity Sensor

The following battery life calculations are based on reading/reporting one register or reading/reporting the contents of all three registers.



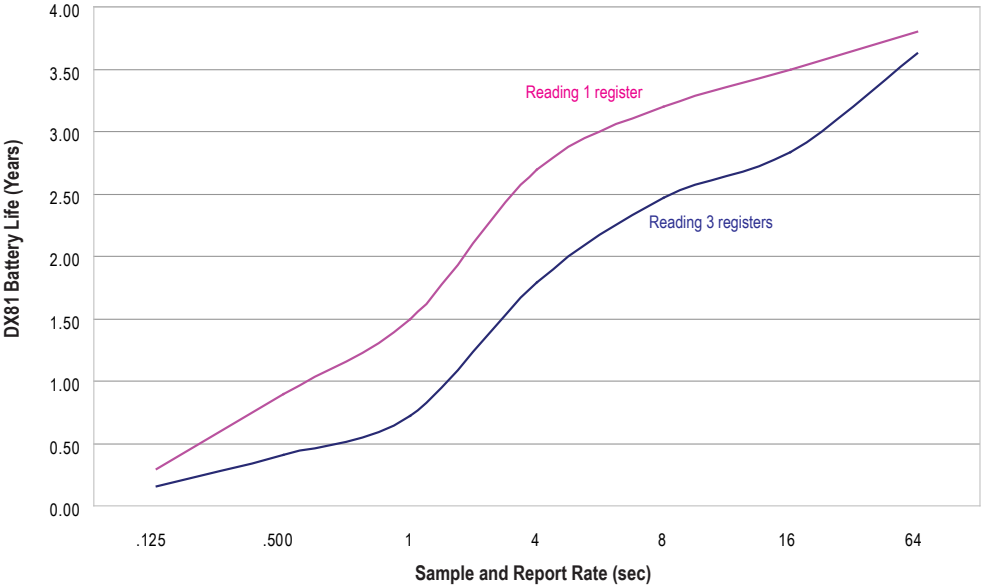

These values are estimated based on the current hardware and software configuration and are subject to change without notice. Environmental conditions will also contribute to the battery’s lifespan. Current estimates are based on a battery operating at room temperature. All battery life calculations are approximations based on a strong radio signal. Weaker radio connections and missed packets will decrease the battery life.

8.3.4 Battery Life of Wireless Q45 Nodes

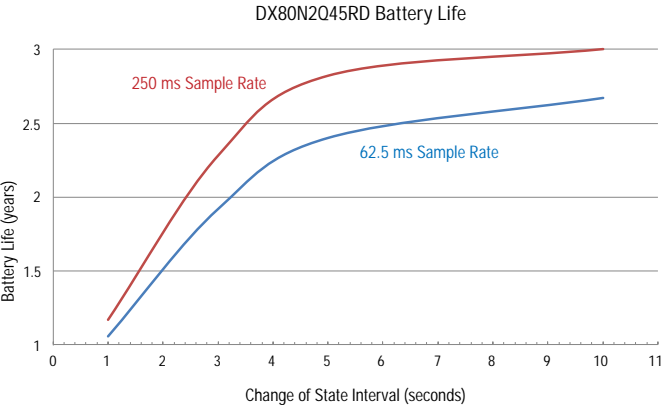
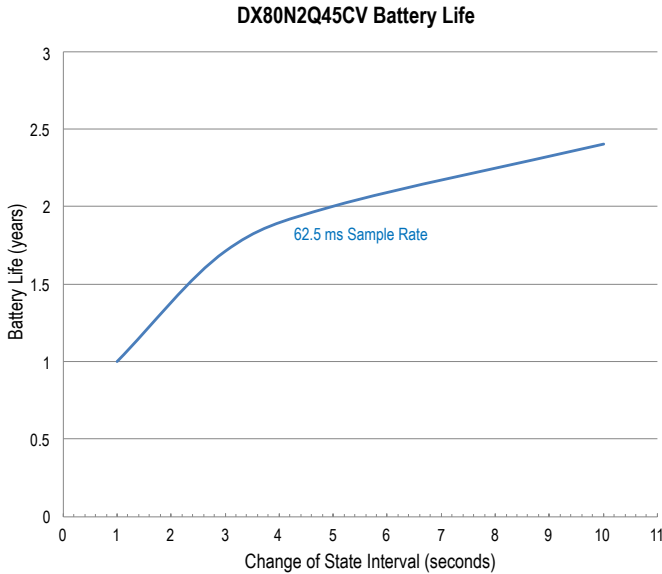

**Q45 Retroreflective Battery Life**

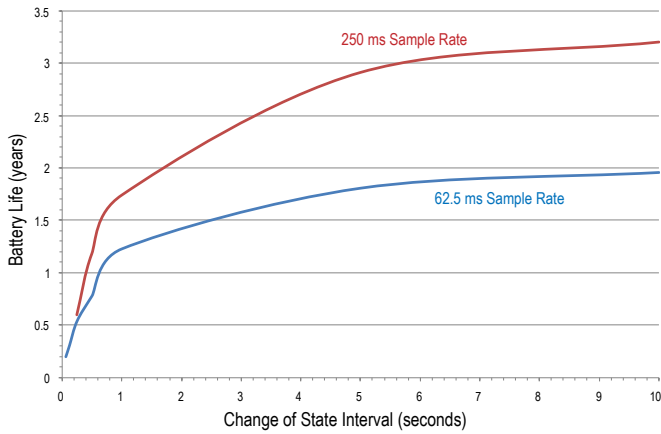

**8.3.5 Battery Life for a P6 Node Connected to a Vibration and Temperature (VT1) Sensor**

The following battery life estimates use the default configuration of the Performance P6 Node, which is a 5 minute sample and report rate.

- 900 MHz 1 Watt: 2.5 years
- 900 MHz 250 mW: 3.4 years
- 2.4 GHz: 4.3 years

**8.3.6 Battery Life for a Q45U Node Connected to a 1-Wire Serial Sensor**

This is the battery life curve for a 1-wire serial sensor (such as a VT1 Vibration/Temperature sensor) connected to a 1-Wire Serial Interface Node, such as a Wireless Q45VT or Q45U Node.

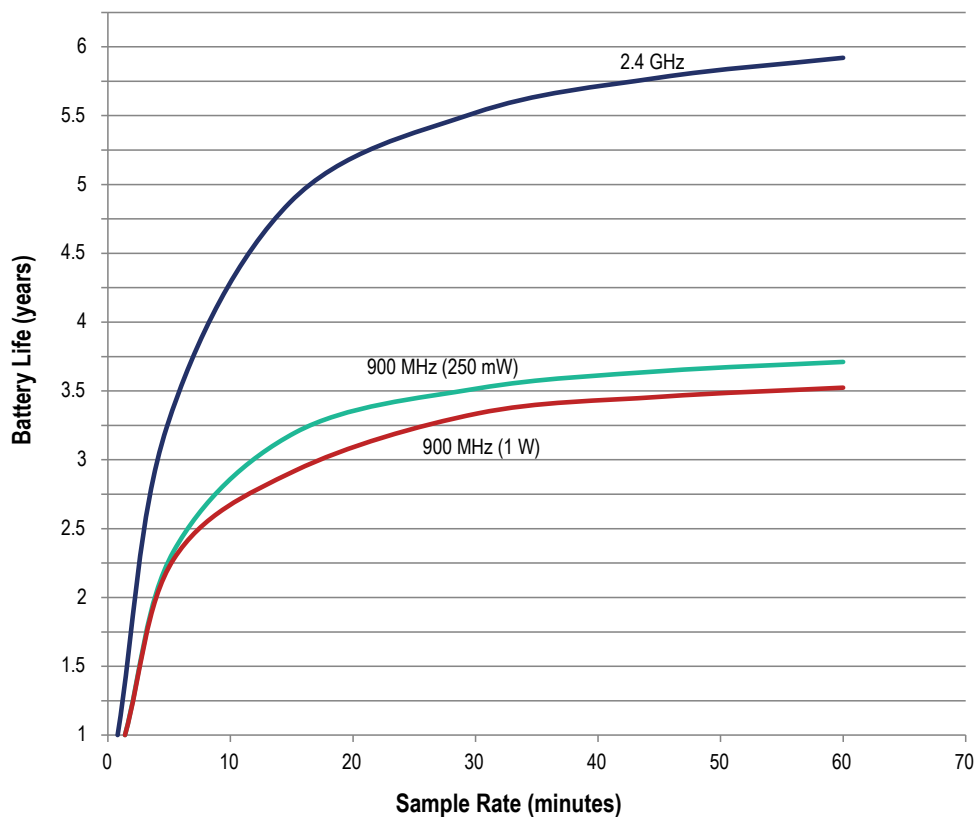

### 8.3.7 Calculating Battery Life

To estimate the battery life for a sensor not included in our list, use the configuration and cable shown (Banner cable BWA-HW-010) to measure the current draw of your system.

1. Connect the cable to the FlexPower Node and the battery supply module as shown below. The cable's male end plugs into the FlexPower Node and the female end plugs into the battery module.
2. Connect an averaging Fluke meter to the leads. Set the meter to read in amps, not milliamps.
3. Turn off the Node's LCD panel by clicking button 2 five times.
4. Allow the meter to measure the operation for at least 10 times the length of the sample rate.

To estimate the battery life in hours:  $\text{Battery Life (in hours)} = (16,000 \text{ mA Hr}) \div (\text{average current in mA})$

To estimate the battery life in years:  $\text{Battery Life (in years)} = (16,000 \text{ mA Hr}) \div [(\text{average current in mA}) (8736 \text{ Hr per year})]$

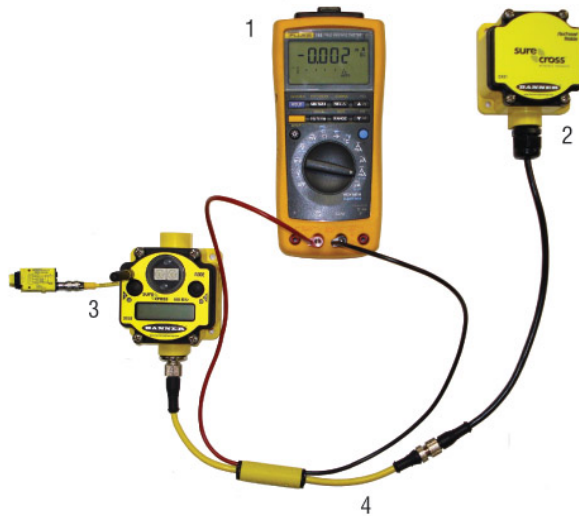

1. Averaging Fluke Meter
2. DX81 Battery Supply Module
3. DX80 FlexPower Node with MINI-BEAM
4. BWA-HW-010 Cable, FlexPower Current Monitoring

## 9 Maintenance

Follow these instructions to perform basic maintenance tasks.

### 9.1 Replacing the Main Body Gasket

---

Check the main body gasket every time a SureCross device is opened.



Replace the gasket when it is damaged, discolored, or showing signs of wear. The gasket must be:

- Fully seated within its channel along the full length of the perimeter, and
- Positioned straight within the channel with no twisting, stress, or stretching.

### 9.2 Replacing the Rotary Dial Access Cover

---

Check the rotary dial access cover o-ring every time the access cover is removed.



Replace the o-ring when it is damaged, discolored, or showing signs of wear. The o-ring should be:

- Seated firmly against the threads without stretching to fit or without bulging loosely, and
- Pushed against the flanged cover.

When removing or closing the rotary dial access cover, manually twist the cover into position. Do not allow cross-threading between the cover and the device's face. After the cover is in place and manually tightened, use a small screwdriver (no longer than five inches total length) as a lever to apply enough torque to bring the rotary dial access cover even with the cover surface.

### 9.3 Battery Replacement

---

#### 9.3.1 Replacing the Battery

When the FlexPower Supply Module is installed outdoors or in a high humidity environment, apply dielectric grease to the battery terminals to prevent moisture and corrosion buildup.

To replace the lithium "D" cell battery in the FlexPower Supply Module, follow these steps.

1. Unplug the battery module from the SureCross device it powers.
2. Remove the four screws mounting the battery module face plate to the body and remove the face plate.
3. Remove the discharged battery by pressing the battery towards the negative terminal to compress the spring. Pry up on the battery's positive end to remove from the battery holder.
4. Replace with a new battery. Only use a 3.6 V lithium battery from Xeno, model number XL-205F.
5. Verify the battery's positive and negative terminals align to the positive and negative terminals of the battery holder mounted within the case. Caution: There is a risk of explosion if the battery is replaced incorrectly.
6. After replacing the battery, allow up to 60 seconds for the device to power up.
7. Properly dispose of your used battery according to local regulations by taking it to a hazardous waste collection site, an e-waste disposal center, or any other facility qualified to accept lithium batteries.

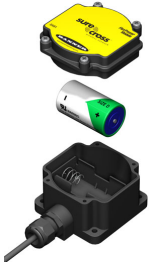

As with all batteries, these are a fire, explosion, and severe burn hazard. Do not burn or expose them to high temperatures. Do not recharge, crush, disassemble, or expose the contents to water.

The battery may be replaced in explosive gas atmospheres.

Replacement battery model number: BWA-BATT-001. For pricing and availability, contact Banner Engineering.



**WARNING:**

- Potential electrostatic charging hazard — only clean with a damp cloth.
- The replacement battery **MUST** be a Banner approved battery, model number BWA-BATT-001. Use of a different battery will **VOID** the intrinsic safety rating of this device and may result in an explosion!
- When replacing the battery, the negative end of the battery holder is the side with the spring terminal. This side is marked with a minus (-) sign.
- Do not attempt to recharge the battery. These batteries are not rechargeable. Recharging may cause serious injury to personnel or damage the equipment. Replace only with factory recommended batteries.

### 9.3.2 Installing or Replacing the **Battery** (DX80 Models)

To install or replace a lithium "D" cell battery in any integrated housing model, follow these steps.

1. Remove the four screws mounting the face plate to the housing and remove the face plate.
2. Remove the discharged battery (if applicable) by pressing the battery toward the negative terminal to compress the spring. Pry up on the battery's positive end to remove from the battery holder.
3. Install the new battery. Only use a 3.6 V lithium battery from Xeno, model number XL-205F.
4. Verify the battery's positive and negative terminals align to the positive and negative terminals of the battery holder mounted within the case. The negative end is toward the spring.

Caution: There is a risk of explosion if the battery is replaced incorrectly.

5. After installing the battery, allow up to 60 seconds for the device to power up.
6. Properly dispose of used batteries according to local regulations by taking it to a hazardous waste collection site, an e-waste disposal center, or other facility qualified to accept lithium batteries.



As with all batteries, these are a fire, explosion, and severe burn hazard. Do not burn or expose them to high temperatures. Do not recharge, crush, disassemble, or expose the contents to water.

Replacement battery model number: BWA-BATT-001. For pricing and availability, contact Banner Engineering.

### 9.3.3 Replacing the **Battery** (DX99...D Models)

To replace the lithium "D" cell battery in the metal housings, follow these steps.

1. Unscrew the lid of the metal enclosure.
2. Lift the radio out of the metal enclosure and pull the spacer frame off the back side of the radio.
3. Disconnect the radio by unplugging the ribbon cable from the radio board and set aside the radio and spacer frame.
4. Remove the discharged battery.
5. Replace with a new battery. Only use a 3.6 V lithium battery from Xeno, model number XL-205F.
6. Verify the battery's positive and negative terminals align to the positive and negative terminals of the battery holder mounted within the case. Caution: There is a risk of explosion if the battery is replaced incorrectly.
7. Wait two minutes.
8. Insert the ribbon cable through the center of the spacer frame, then plug the ribbon cable back into the radio board.

9. Insert the radio back onto the spacer frame pins. Push the radio and spacer frame assembly back into the enclosure until it is seated.
10. Screw on the lid and tighten.
11. After replacing the battery, allow up to 60 seconds for the device to power up.
12. Properly dispose of your used battery according to local regulations by taking it to a hazardous waste collection site, an e-waste disposal center, or other facility qualified to accept lithium batteries.



As with all batteries, these are a fire, explosion, and severe burn hazard. Do not burn or expose them to high temperatures. Do not recharge, crush, disassemble, or expose the contents to water.

The battery may be replaced in explosive gas atmospheres. Replacement battery model number: BWA-BATT-001. For pricing and availability, contact Banner Engineering.



**WARNING:**

- Do not replace battery when an explosive dust atmosphere may be present.
- The replacement battery **MUST** be a Banner approved battery, model number BWA-BATT-001. Use of a **different** battery will **VOID** the intrinsic safety rating of this device and may result in an explosion!
- When replacing the battery, the negative end of the battery holder is the side by the large capacitors. This side is marked with a minus (-) sign.
- Do not attempt to recharge the battery. These batteries are not rechargeable. Recharging may cause serious injury to personnel or damage the equipment. Replace only with factory recommended batteries.

# 10 Troubleshooting

The following troubleshooting tips include some basic instructions for common problems.

## 10.1 Startup Problems

The following problems are associated with starting up your radios.

The radio won't wake up. While in storage mode, the radio does not operate. All Sure Cross® radios powered from an integrated battery ship from the factory in storage mode to conserve the battery. To wake the device, press and hold button 1 for 5 seconds. To put any FlexPower® or integrated battery Sure Cross radio into storage mode, press and hold button 1 for 5 seconds. The radio is in storage mode when the LEDs stop blinking, but in some models, the LCD remains on for an additional minute after the radio enters storage mode. After a device has entered storage mode, you must wait 1 minute before waking it.

The sensors are not powered. Many SureCross devices have several switch power outputs for powering sensors. Enable the power supplies using the I/O point parameters for sensor supply #, supply output voltage, and warm-up time.

The radio seems only **partially** powered. If your ribbon cable has been unplugged from the radio board, verify the ribbon cable is fully seated and that it has been plugged into all pins. It is possible to accidentally plug in the ribbon cable and miss the top row of pins (shown). When the ribbon cable is plugged in incorrectly, the radio may partially power up, but it will not be able to communicate to any sensors nor will it communicate with the wireless network.





The radio won't enter binding mode. If you did not disconnect the power before changing the DIP switch positions, you must cycle power to the device. If you do not cycle power, the device does not register the DIP switch changes. For devices with an integrated battery, cycle the power by removing the battery for one minute.

## 10.2 LED Message Codes

Solid or flashing LEDs mean different things depending on whether the device is a Gateway, GatewayPro, Node, or DX85 Remote I/O Modbus Slave.

LED 1	LED 2	Definition/Solution
● Solid green		Gateway, DX85: Power is on
⊙ Flashing green		Node: Good radio communication link
	⊙ Flashing amber	Gateway, DX85: Active Modbus communication
⊙ Flashing red	⊙ Flashing red	Device error. If the LCD also reports BAD EE, contact the factory for replacement.

LED 1	LED 2	Definition/Solution
	 Flashing red	<p>Gateway, DX85: Modbus communication error</p> <p>For a Gateway system, a Modbus communications error indicates a bad transmission or checksum error between the host and the Gateway device. For a GatewayPro system, a Modbus communications error indicates a communications problem internal to the GatewayPro. For a Gateway and Ethernet Bridge system, a Modbus communication error indicates a communication problem between the Gateway and the Ethernet Bridge.</p> <p>Solutions:</p> <ol style="list-style-type: none"> <li>1. The default communications settings for the RS485 port are: 1 start bit, 8 data bits, no parity, 1 stop bit, and 19.2k baud. The DX80 Gateway uses Modbus RTU protocol for all communications. Supported Modbus function codes are 3, 6, and 16.</li> <li>2. Verify the DX80 model supports RS485 serial communications.</li> <li>3. RS485 termination or biasing is not supplied on the Gateway and should be provided externally to the DX80. (Termination is not required by the Gateway, proper biasing of the serial lines is required.)</li> <li>4. Bad connection or bad cable.</li> </ol>
	 Flashing red	<p>Node: No radio communication</p> <p>There are two settings on every Node device used to synchronize to the Gateway device:</p> <ul style="list-style-type: none"> <li>• The Node must be bound to the Gateway.</li> <li>• Each Node ID within that network must be set to a unique number.</li> </ul> <p>Solutions:</p> <ol style="list-style-type: none"> <li>1. If the Gateway and Node are less than two meters apart, device communication may fail (radios may saturate). If the Gateway is less than two meters from another Gateway, send and receive transmissions between all devices the Gateways communicate with fails.</li> <li>2. The Gateway and Node may be too far apart to achieve synchronization – consult the factory for options.</li> <li>3. Use a qualified antenna on both the Gateway and Node devices.</li> <li>4. After any system parameter change, cycle the power to re-synchronize all devices.</li> <li>5. When a Node loses synchronization, it is programmed to attempt re-synchronization for five seconds, then sleep for fifteen seconds. Synchronizing may require up to twenty seconds.</li> <li>6. Re-cycle power on the Gateway and Node devices.</li> </ol>
	Not blinking amber	<p>GatewayPro: No Modbus communication</p> <p>Solution:</p> <ol style="list-style-type: none"> <li>1. The GatewayPro’s LED 2 should always be blinking amber to indicate Modbus communication. If the LED 2 does not blink amber, verify the baud rates, slave IDs, parity, and stop bits are set correctly.</li> <li>2. Check the cables connecting the GatewayPro to the host device.</li> </ol>
No LED 1	No LED 2	<p>All DX80 devices display “POWER” on the LCD for the first five to ten seconds after applying power. A DX80 Gateway always has a green LED 1 on when power is connected. DX80 Node devices flash a red LED 2 every three seconds or a green LED 1 every second depending on the RF Link status.</p> <p>If no LEDs are lighting up:</p> <ol style="list-style-type: none"> <li>1. Put battery powered devices into power-down mode by pressing and holding button 1 for three to five seconds. To return from power-down mode, press and hold button 1 for three to five seconds.</li> <li>2. Recheck the power connections and power requirements. Battery-powered devices require 3.6–5.5V dc. Non-battery powered devices require 10–30V dc.</li> <li>3. After replacing the battery, allow up to sixty seconds for the device to power up.</li> <li>4. The GatewayPro cannot be attached to another Modbus master device or a Modbus slave ID 1 via RS-485. Special configuration using the Web page configuration tool allows the GatewayPro to become a slave unit when necessary.</li> </ol>



## 10.3 LCD Message Codes

These message codes display on the device's LCD.

Message	Solution
BAD EE	System Error. A system error typically represents a failure of the EE PROM. Contact the factory for replacement.
EC XX	The XX refers to the Modbus register 8 message code shown in <a href="#">Modbus Message Codes for Register 8</a> on page 73. The LCD displays the message code in decimal; host-controlled systems read the message codes in hex.  DX80 display shows *ERROR: The Gateway uses fully-acknowledged polling to ensure each Node radio link is robust. If a prescribed number of sequential polling cycles are not acknowledged by a Node, the Gateway considers the radio link with that Node to be timed out. All outputs on the Node in question are set to the user-selected default state or the output holds its last state, depending on user configuration options set using the User Configuration Tool. If the Node's radio link recovers and the Gateway or GatewayPro determines enough acknowledged polling messages have accumulated, the link is reinstated.
EC 53	Radio Device (polling/heartbeat) Timeout. (Decimal value 13569.) A Node dropped out of the wireless network based on the parameters defined for polling or heartbeat. For more information, see Message Code 35 in <a href="#">Modbus Message Codes for Register 8</a> on page 73.
EC 54	Modbus time-out. A Gateway timeout (time of inactivity on the serial channel) was detected. For more information, see Message Code 36 in <a href="#">Modbus Message Codes for Register 8</a> on page 73.
No LCD	All DX80s display "POWER" on the LCD for the first 5 to 10 seconds after applying power. A Gateway's LED 1 is solid green when power is connected. Nodes flash a red LED 2 every 3 seconds or a green LED 1 every second depending on the radio link status. <ul style="list-style-type: none"> <li>Battery-powered devices turn off the LCD after 15 minutes (factory default). Push any button to reactivate the LCD. Battery-powered devices may be in storage mode. To put battery powered devices into storage mode, hold button 1 for 5 seconds. To return from storage mode, hold button 1 for 5 seconds.</li> <li>Recheck the power connections and power requirements. Battery-powered devices require 3.6 to 5.5 V dc. Non-battery powered devices require 10 to 30 V dc.</li> <li>After replacing the battery, allow up to sixty seconds for the device to power up.</li> </ul>

### 10.3.1 Modbus Message Codes for Register 8

Register I/O 8 is reserved for device messages or Site Survey data when in Site Survey mode.

Conditions are detected as they occur and are reported to the Gateway. After the message is sent to the Gateway, the Node does not resend the message until the condition changes or there is a higher priority message. The higher the message code, the higher the priority. For more information about how Site Survey data is stored in registers 7 and 8, refer to [Conducting a Site Survey \(Gateway and Nodes\)](#) on page 16.

The following are the Modbus message codes, shown in hex, that may appear on the SureCross devices' I/O 8 Modbus register.

Message Code [15:8]	Data Field [7:0]	Description
00	80	Normal operation. Device message register contents 0x0080 indicate the Node is synchronized to the Gateway. (Decimal value 128.) A value of zero (0) indicates there is no device present.
01	00-FF	Unknown message. The message was received correctly (correct checksum), but it is not a recognized command. This type of message is usually caused by devices with poor radio links or collocated networks that are not uniquely separated by binding codes and Network IDs. Network performance is not affected. (Decimal values 256 through 511.)
35	01	Radio Device (polling/heartbeat) Timeout. (Decimal value 13569.) A Node dropped out of the wireless network based on the polling or heartbeat parameters. Refer to the User Configuration Tool documentation for polling or heartbeat parameters and the timeout operation. When the least significant bit is on (1), an error condition exists. <ul style="list-style-type: none"> <li>Run a site survey to determine the quality of the radio link. If no communication exists between the Gateway and Node, verify the power at the Node and all antenna connections. Blocked radio communications may also be a result of recently changed environmental conditions.</li> <li>Replace the battery of a battery-powered Node. Although the LCD and device may appear functional, the battery may not have enough capacity to handle radio communication.</li> </ul>
36	01	Modbus time-out. A Gateway timeout (inactivity on the serial channel) was detected. (Decimal value 13825.) When the least significant bit is on (1), an error condition exists.
FE	--	Modbus register 8 device messages are disabled. The Modbus register 8 clears or disables messages using the Gateway's Modbus register 15. (Decimal values 65024 through 65279.)

## 10.4 Inputs and Outputs

Some inputs or outputs are not working.

**Option 1.** From the Node, access the menu system and use manual scrolling mode within \*RUN to freeze the I/O status on the LCD display for the device in question. Verify that when the input device changes state or changes value, the LCD mirrors the behavior. If the Node is in a hazardous location, access the Node's I/O from the Gateway by changing the Gateway's right rotary dial to the Node number in question. For example, to view the I/O status of Node 3, move the Gateway's right rotary dial to 3. The Gateway's LCD now scrolls through Node 3's I/O. To freeze the display on a particular I/O point, double-click button 2. The autoscrolling on the Gateway stops at the \*RUN screen. Single-click button 1 to advance through the Node's I/O points.

**Option 2.** Verify the LCD on the output side mirrors the linked input's behavior. If the input device state LCD on the origination DX80 and the LCD on the destination DX80 behave the same, there may be a wiring issue or an interfacing problem. Consult the factory.

**Option 3.** Nodes will not sample inputs unless the Nodes are in sync with a Gateway. Verify your Node is in sync with its Gateway.

## 10.5 Radio Link Time-Out and Recovery (Non-Host Connected Systems)

The SureCross® wireless devices employ a deterministic link time-out method to address radio link interruption or failure. When a specific Node/Gateway radio link fails, all pertinent wired outputs are de-energized until the link is recovered (see component datasheet for more information.) Through this process, users of Banner wireless networks can be assured that disruptions in the communications link result in predictable system behavior.

The link time-out feature uses a fully-acknowledged polling method to determine the radio link status of each Node on the network.

If after a specified number of sequential polling cycles the Node does not acknowledge a message, the Gateway considers the link with that Node timed out. The LCDs on both the Node and Gateway show \*ERROR. Following a time-out, the Node de-energizes outputs and the Gateway sets all outputs linked to the Node in question to a de-energized state. Inputs from the Node mapped to outputs on the Gateway are suspended during a link time-out.

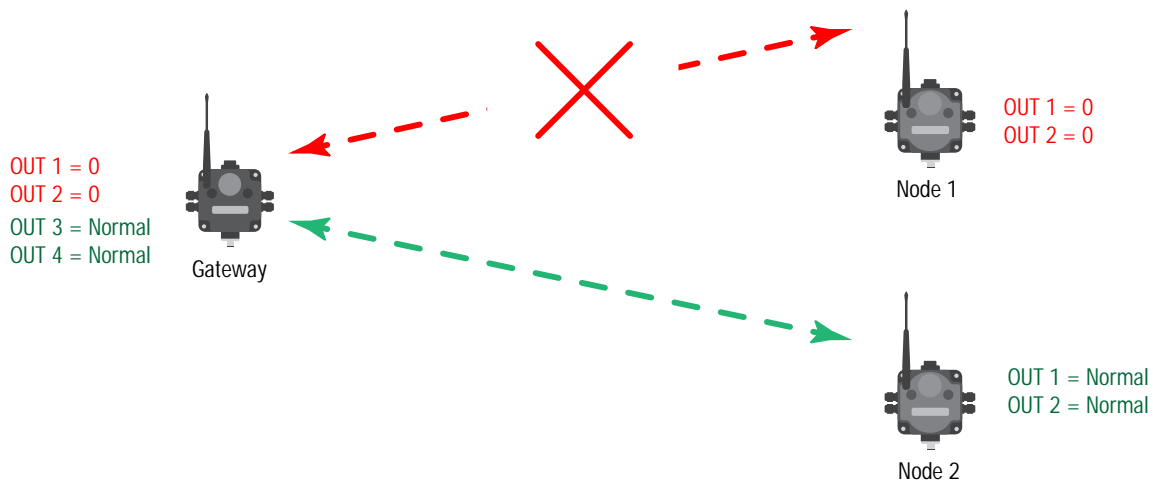

Figure 3. Radio link between the Gateway and Node 1 has timed out.

After a link has failed, the Gateway must receive a specified number of good data packets from the Node in question before the link is reinstated. Outputs are restored to current values after the link recovers.

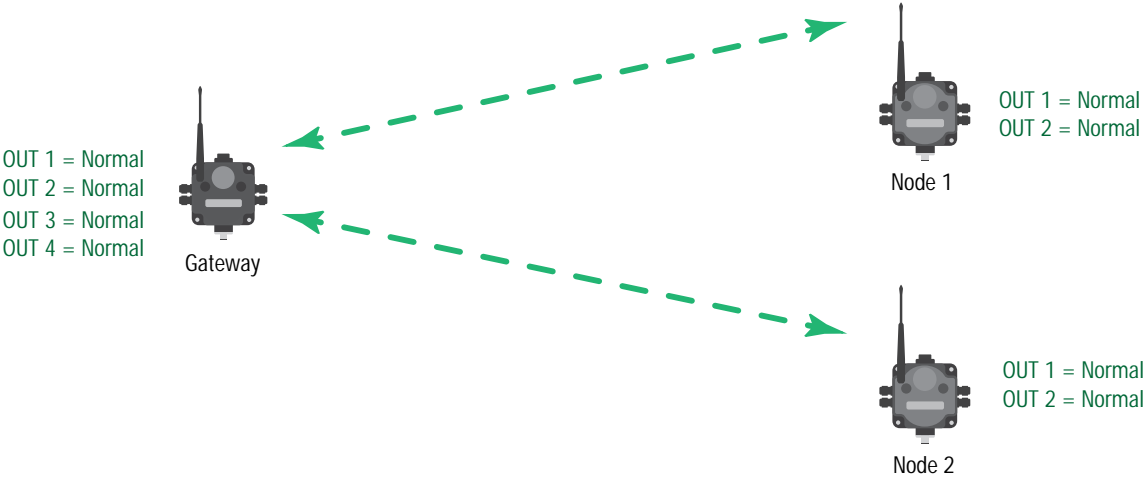

Figure 4. Radio link between the Gateway and Node 1 has recovered.

# 11 Accessories

The accessories list includes FCC approved antennas, antenna cabling, surge suppressors, power supplies, replacement batteries, enclosures, cables, and other hardware.

## 11.1 Selecting an Enclosure

Select the enclosure size based on what you intend to mount inside it. Always select the largest enclosure you can to allow for future expansion.

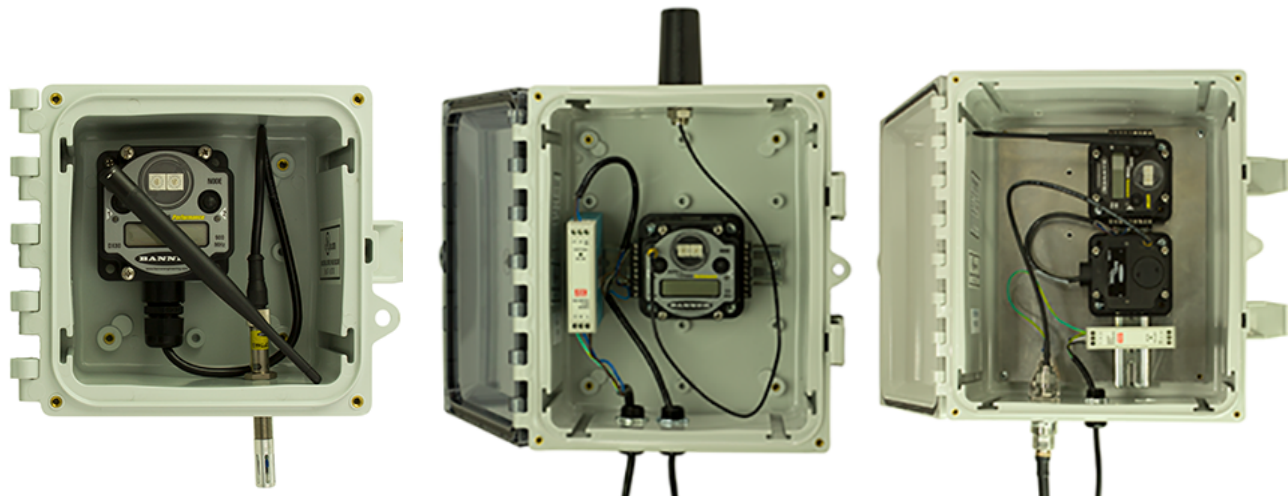

6 × 6 inch: Fits a single DX80.

10 × 8 inch: Fits a power supply, surge suppressor, a single DX80, and a few relays. This is a popular size but can get cramped.

12 × 10 inch: This is the recommended size; provides ample room for multiple radios and accessories.

### 11.1.1 Polycarbonate Enclosures

Polycarbonate Enclosures with Opaque Covers		Polycarbonate Enclosures with Clear Covers	
Models	Description	Models	Description
<a href="#">BWA-AH664</a>	Enclosure, Polycarbonate, with Opaque Cover, 6 × 6 × 4	<a href="#">BWA-AH664C</a>	Enclosure, Polycarbonate, with Clear Cover, 6 × 6 × 4
<a href="#">BWA-AH864</a>	Enclosure, Polycarbonate, with Opaque Cover, 8 × 6 × 4	<a href="#">BWA-AH864C</a>	Enclosure, Polycarbonate, with Clear Cover, 8 × 6 × 4
<a href="#">BWA-AH1084</a>	Enclosure, Polycarbonate, with Opaque Cover, 10 × 8 × 4	<a href="#">BWA-AH1084C</a>	Enclosure, Polycarbonate, with Clear Cover, 10 × 8 × 4
<a href="#">BWA-AH12106</a>	Enclosure, Polycarbonate, with Opaque Cover, 12 × 10 × 6	<a href="#">BWA-AH12106C</a>	Enclosure, Polycarbonate, with Clear Cover, 12 × 10 × 6
<a href="#">BWA-AH14126</a>	Enclosure, Polycarbonate, with Opaque Cover, 14 × 12 × 6	<a href="#">BWA-AH14126C</a>	Enclosure, Polycarbonate, with Clear Cover, 14 × 12 × 6
<a href="#">BWA-AH16148</a>	Enclosure, Polycarbonate, with Opaque Cover, 16 × 14 × 8	<a href="#">BWA-AH16148C</a>	Enclosure, Polycarbonate, with Clear Cover, 16 × 14 × 8
<a href="#">BWA-AH181610</a>	Enclosure, Polycarbonate, with Opaque Cover, 18 × 16 × 10	<a href="#">BWA-AH181610C</a>	Enclosure, Polycarbonate, with Clear Cover, 18 × 16 × 10

Swing Panel Kits	
Models	Description
BWA-AH66SPK	Swing Panel Kit, 6 × 6, includes mounts and screws
BWA-AH86SPK	Swing Panel Kit, 8 × 6, includes mounts and screws
BWA-AH108SPK	Swing Panel Kit, 8 × 10, includes mounts and screws
BWA-AH1210SPK	Swing Panel Kit, 12 × 10, includes mounts and screws
BWA-AH1412SPK	Swing Panel Kit, 14 × 12, includes mounts and screws
BWA-AH1614SPK	Swing Panel Kit, 16 × 14, includes mounts and screws
BWA-AH1816SPK	Swing Panel Kit, 18 × 16, includes mounts and screws

Back Panel Kits	
Models	Description
BWA-BP66A	Back Panel, Aluminum, 6 × 6
BWA-BP86A	Back Panel, Aluminum, 8 × 6
BWA-BP108A	Back Panel, Aluminum, 10 × 8
BWA-BP1210A	Back Panel, Aluminum, 12 × 10
BWA-BP1412A	Back Panel, Aluminum, 14 × 12
BWA-BP1614A	Back Panel, Aluminum, 16 × 14
BWA-BP1816A	Back Panel, Aluminum, 18 × 16

DIN Rail Kits (with Self-Threading Screws)	
Models	Description
BWA-AH6DR	DIN Rail Kit, 6", 2 trilobular/self-threading screws
BWA-AH8DR	DIN Rail Kit, 8", 2 trilobular/self-threading screws
BWA-AH10DR	DIN Rail Kit, 10", 2 trilobular/self-threading screws
BWA-AH12DR	DIN Rail Kit, 12", 2 trilobular/self-threading screws
BWA-AH14DR	DIN Rail Kit, 14", 2 trilobular/self-threading screws
BWA-AH16DR	DIN Rail Kit, 16", 2 trilobular/self-threading screws
BWA-AH18DR	DIN Rail Kit, 18", 2 trilobular/self-threading screws
BWA-AHTBS	Trilobular/self-threading screws, #10-32 × 0.375 PHL PH ZINC, 10 pack

Enclosure Accessories	
Models	Description
BWA-AHAK	Accessory Kit, includes all screws, inserts, and mounting feet, for replacement only

### 11.1.2 Fiberglass Enclosures

Models	Description	
<a href="#">BWA-EF1086</a>	Hinged fiberglass enclosure, 10" × 8" × 6"	
<a href="#">BWA-EF866</a>	Hinged fiberglass enclosure, 8" × 6" × 6"	
BWA-PANEL-108	Panel, 10 × 8	
BWA-PANEL-86	Panel, 8 × 6	

## 11.2 Selecting an Antenna

Select your antenna based on your specific application needs. There are three basic antenna solutions:

- Use the supplied rubber duck antenna inside the enclosure. DX80 products come with a 2 dBi rubber duck antenna. Often simply attaching the supplied antenna to the radio provides enough radio range to meet your needs.
- Mount a dome antenna to the enclosure. The -D antennas can be mounted directly on the enclosure.
- Use an N-type pole-mounted antenna, with surge suppressor. The -A and -AS antennas can be mounted remotely from the enclosure and require the BWC-LFNBMN-DC surge suppressor.

## 11.2.1 Antennas: Rubber RP-SMA

The following rubber, or rubber duck, antennas have an RP-SMA male connection.

### Omni-Directional Antennas with RP-SMA Male Connections

#### BWA-902-C

- 2 dBi, Rubber swivel, 900 MHz (ships with 900 MHz radios)
- Datasheet: [b\\_3145120](#)

#### BWA-905-C

- 5 dBi, Rubber swivel, 900 MHz
- Datasheet: [b\\_3145123](#)

#### BWA-202-C

- 2 dBi, Rubber swivel, 3 1/4 inches, 2.4 GHz (ships with 2.4 GHz radios)
- Datasheet: [b\\_3145114](#)

#### BWA-205-C

- 5 dBi, Rubber swivel, 6 1/2 inches, 2.4 GHz
- Datasheet: [b\\_3145116](#)

#### BWA-207-C

- 7 dBi, Rubber swivel, 9 1/4 inches, 2.4 GHz
- Datasheet: [b\\_3145118](#)



#### BWA-902-RA

- 2 dBi, Rubber fixed right angle
- 900 MHz

#### BWA-902-RA2

- 2 dBi 1/2-wave, Rubber fixed right angle
- 900 MHz
- 160 mm tall

#### BWA-201-001

- 1 dBi, Rubber, 1 inch tall
- 2.4 GHz



## 11.2.2 Antennas: Dome

#### BWA-902-D

- Dome antenna, 2 dBi, 18-inch cable, 900 MHz
- RP-SMA Box Mount
- Datasheet: [b\\_314512](#)

#### BWA-202-D

- Dome antenna, 2 dBi, 18-inch cable, 2.4 GHz
- RP-SMA Box Mount
- Datasheet: [b\\_3145115](#)



For remote mounting options, use bracket SMBAMS18RA listed in the [Brackets and Mounting Options](#) on page 82 section.

## 11.2.3 Antennas: Other

#### BWA-205-M

- Magnetic whip antenna, 5 dBi, 12 ft cable, 2.4 GHz
- RP-SMA Male connection



## 11.2.4 Antennas: Fiberglass N-Type

The following fiberglass antennas are typically used outdoors.

### Omni-Directional Fiberglass Antennas with N-Type Female Connections

- BWA-906-A
  - 6 dBi, Fiberglass, Full wave, 71.5 inches, 900 MHz
  - Datasheet: [b\\_314512](#)
- BWA-208-A
  - 8.5 dBi, Fiberglass, 24 inches, 2.4 GHz
  - Datasheet: [b\\_3145131](#)
- BWA-206-A
  - 6 dBi, Fiberglass, 16 inches (shown), 2.4 GHz
  - Datasheet: [b\\_3145117](#)
- BWA-906-AS
  - 6 dBi, Fiberglass, 1/4 Wave, 23.6 inches (1.3 inch dia.), 900 MHz
  - Datasheet: [b\\_3145125](#)
- BWA-908-AS
  - 8 dBi, Fiberglass, 3/4 Wave, 63 inches (1.5 inch dia.), 900 MHz
  - Datasheet: [b\\_3145126](#)



### 11.2.5 Antennas: Yagi N-Type

**Directional (Yagi) Antennas with an N-Type Female Connection**

- BWA-9Y6-A
  - 6.5 dBi, 6.8 × 13 inches Outdoor, 900 MHz
  - Datasheet: [b\\_3145127](#)
- BWA-9Y10-A
  - 10 dBi, 6.8 × 24 inches Outdoor, 900 MHz
  - Datasheet: [b\\_3145130](#)



### 11.2.6 Antennas: Cellular

- BWA-CDMA-002
  - CDMA cellular multiband
  - 2 dBi
  - RP-SMA male connection
  - 6.3 inch blade style

### 11.2.7 Antenna Cables: RP-SMA to RP-SMA

Use these cables to connect a radio to a bulkhead surge suppressor or a bulkhead surge suppressor to an RP-SMA antenna. These cables may be used inside an enclosure or without an enclosure.

RP-SMA to RP-SMA Antenna Cables—RG58 Type			
Model	Length (m)	Description	
BWC-1MRSFRS0.2	0.2	RG58, RP-SMA Male to RP-SMA Female Bulkhead	
BWC-1MRSFRS1	1		
BWC-1MRSFRS2	2		
BWC-1MRSFRS4	4		

RP-SMA to RP-SMA Antenna Cables—LMR200 Type			
Model	Length (m)	Description	
BWC-2MRSFRS3	3	LMR200, RP-SMA Male to RP-SMA Female	
BWC-2MRSFRS6	6		
BWC-2MRSFRS9	9		

RP-SMA to RP-SMA Antenna Cables—LMR200 Type			
Model	Length (m)	Description	
BWC-2MRSFRS12	12		

### 11.2.8 Antenna Cables: RP-SMA to N-Type

Use an LMR100 cable to connect a radio to an N-type antenna, N-type antenna extension cable, or N-type surge suppressor. These cables may be used inside or outside the enclosure or without an enclosure.

RP-SMA to N-Type Cables—LMR100 Type			
Model	Length (m)	Description	
BWC-1MRSMN05	0.5	LMR100 RP-SMA to N-Type Male	
BWC-1MRSMN2	2		

### 11.2.9 Antenna Cables: N-Type

These LMR400 cables are antenna extension cables, connecting an N-type antenna to another N-type antenna cable. These cables are usually used outside the enclosure.

N-Type to N-Type Cables—LMR400 Type			
Model	Length (m)	Description	
BWC-4MNFN3	3	LMR400 N-Type Male to N-Type Female	
BWC-4MNFN6	6		
BWC-4MNFN15	15		
BWC-4MNFN30	30		

### 11.2.10 Surge Suppressors

Always install and properly ground a qualified surge suppressor when installing a remote antenna system (antenna not directly connected to the Sure Cross radio). Remote antenna configurations installed without a surge suppressor invalidate the manufacturer's warranty.

#### BWC-LMRSFRPB

- Surge Suppressor, Bulkhead, RP-SMA Type
- RP-SMA to RP-SMA



#### BWC-LFNBMN-DC

- Surge Suppressor, bulkhead, N-Type, dc Blocking
- N-Type Female, N-Type Male



## 11.3 Power Supplies



### 11.3.1 DC Power Supplies

Models	Description	
PSW-24-1	DC Power Supply, 100-240 V ac 50/60 Hz input, 24 V dc 1 A output, UL Listed Class 2	
<a href="#">PSD-24-4</a>	DC Power Supply, 90-264 V ac 50/60 Hz input, 24 V dc output, US-style wall plug input, 4-pin M12/ Euro-style output; 2 m (6 ft) cable, UL Listed Class 2	



Models	Description	
<a href="#">PSDINP-24-06</a>	DC Power Supply, 0.63 Amps, 24 V dc, with DIN Rail Mount, Class I Division 2 (Groups A, B, C, D) Rated	
<a href="#">PSDINP-24-13</a>	DC Power Supply, 1.3 Amps, 24 V dc, with DIN Rail Mount, Class I Division 2 (Groups A, B, C, D) Rated	
<a href="#">PSDINP-24-25</a>	DC Power Supply, 2.5 Amps, 24 V dc, with DIN Rail Mount, Class I Division 2 (Groups A, B, C, D) Rated	

### 11.3.2 FlexPower Supplies and Replacement Batteries

Power Supplies		
Models	Description	
<a href="#">DX81-LITH</a>	Battery Supply Module with mounting hardware	
<a href="#">DX81H</a>	Battery Supply Module with mounting hardware, for DX99 polycarbonate housing devices	
<a href="#">DX81P6</a>	Battery Supply Module, six "D" cells, with mounting hardware	
<a href="#">BWA-SOLAR PANEL 3W</a>	Solar Panel, 12 V, 3 W, Multicrystalline, 188 × 195 × 15, Wall/Pole clamp style mounting bracket included (does not include controller)	
<a href="#">BWA-SOLAR PANEL 5W</a>	Solar Panel, 12 V, 5 W, Multicrystalline, 270 × 222 × 17, Wall/Pole clamp style mounting bracket included (does not include controller)	
<a href="#">BWA-SOLAR PANEL 20W</a>	Solar Panel, 12 V, 20 W, Multicrystalline, 573 × 357 × 30, "L" style mounting bracket included (does not include controller)	
<a href="#">BWA-SOLAR CNTRL-12V</a>	Solar Controller, 6 A Load Current, 12 V System Voltage, recommended for 20 W or less solar panel and a Sealed Lead Acid Battery (sold separately)	

Replacement Batteries		
Model	Description	
BWA-BATT-001	Lithium "D" cell for DX81-LITH and DX81H Battery Supply Module, 1 battery	
BWA-BATT-006	Lithium "AA" cell for Wireless Q45 Sensors, 2 batteries	

### 11.4 Relays

Models	Description	
<a href="#">IB6RP</a>	Interface Relay Box, 18 to 26 V dc inputs, isolated relay outputs (not shown)	
<a href="#">BWA-RELAY-12V</a>	Relay, Blade Style with Base, 12 V	
<a href="#">BWA-RELAY-24V</a>	Relay, Blade Style with Base, 24 V	
<a href="#">BWA-RH1B-UDC12V</a>	Relay, Blade Style, No Base, 12 V (replacement part)	
<a href="#">BWA-RH1B-UDC24V</a>	Relay, Blade Style, No Base, 24 V (replacement part)	

Models	Description
<a href="#">BWA-SH1B-05</a>	Relay Base Only (replacement part)

## 11.5 Brackets and Mounting Options

### BWA-HW-001 Mounting Hardware Kit

- Screw, M5-0.8 x 25 mm, SS (4)
- Screw, M5-0.8 x 16 mm, SS (4)
- Hex nut, M5-0.8 mm, SS (4)
- Bolt, #8-32 x 3/4", SS (4)

### Brackets

#### SMBDX80DIN

- Black reinforced thermoplastic
- Bracket for mounting on a 35 mm DIN rail

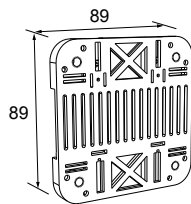

#### DIN-35-..

35 mm DIN Rail

Model	Length
DIN-35-70	70
DIN-35-105	105
DIN-35-140	140

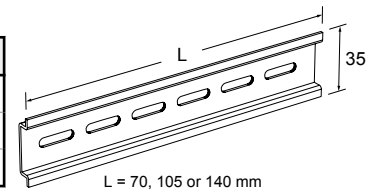

Hole center spacing: 35.1  
Hole size: 25.4 x 5.3

Use to mount DX80 board-level devices, such as DX80Nx-PBx or DX80DRx-HBx models.

#### BWA-HW-034

- DIN rail clip, black plastic



This standard Banner bracket can also be used to remotely mount dome antennas.

#### SMBAMS18RA

- Right-angle SMBAMS series bracket with 18 mm hole
- Articulation slots for 90+° rotation
- 12-ga. (2.6 mm) cold-rolled steel

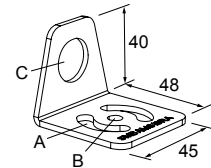

Hole center spacing: A = 26.0, A to B = 13.0  
Hole size: A = 26.8 x 7.0, B = ø 6.5, C = ø 19.0

Use to mount vibration sensor models QM42VT1 and VT2.

#### BWA-BK-001

- Includes magnetic mounting bracket SMB42FLM12 and 2 mounting screws

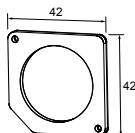

Use to mount vibration sensor models QM42VT1 and VT2.

#### BWA-BK-002

- Includes SMB42FL stainless steel bracket, 1/4"-28 screw mount, and 1 piece of 3M™ thermally conductive adhesive transfer tape

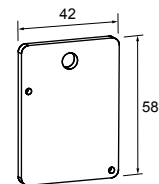

**Brackets**

**BWA-BK-004**

- Mounts both the K50U Ultrasonic sensor and a Wireless Q45U Node or DX80 Node

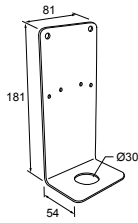

**BWA-BK-006**

- Mounts both the K50U Ultrasonic sensor and a Wireless Q45U Node

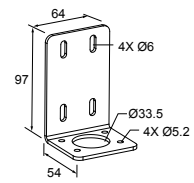

**Adhesive Mounts**

**BWA-HW-057**

- 3M™ Thermally Conductive Adhesive Transfer Tape 8820
- Provides a heat-transfer path between heat-generating components and heat sinks or other cooling devices
- 3 pieces per pack
- Tape is 20 mils (0.50 mm) thick; liner is 1.5-2 mil (37.5-50 µm) thick
- Thermally conductive ceramic filler
- Dual liner using silicone-treated polyester: easy-release PET liner is clear, tight side PET liner is blue

**11.6 Cables**

**11.6.1 Ethernet Cables**

Use a crossover cable to connect the GatewayPro or DX83 Ethernet Bridge to a host system without using an Ethernet switchbox or hub. When using a switchbox or hub, use a straight cable.

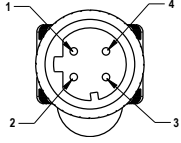
RSCD RJ45 Ethernet to 4-Pin M12/Euro-Style Cordsets				
Model	Length	Style	Dimensions	Pinout
BWA-E2M	2 m (6.6 ft)	Straight RSCD RJ45 440		  1 = White/orange (+Tx) 2 = Orange (-Tx) 3 = White/blue (+Rx) 4 = N/C 5 = N/C 6 = Blue (-Rx) 7 = N/C 8 = N/C
BWA-E8M	8 m (26.2 ft)			
BWA-EX2M	2 m (6.6 ft)	Crossover RSCD RJ45CR 440		1 = White/Orange (+Tx) 2 = White/Blue (+Rx) 3 = Orange (-Tx) 4 = Blue (-Rx)

## 11.6.2 Adapter Cables

### BWA-HW-006

- Adapter cable, USB to RS-485
- For use with the User Configuration Tool software (UCT)
- Datasheet: [140377](#)

### BWA-UCT-900 (shown)

- Adapter cable with power, USB to RS-485
- For use with the User Configuration Tool software (UCT)
- Supplies power to 1 Watt radios
- Datasheet: [140377](#)



### BWA-USB1WIRE-001

- PC USB to 1-wire serial interface converter
- Use with the Sensor Configuration Tool software to communicate directly with 1-wire serial interface sensors
- Datasheet: [170020](#)



## 11.6.3 Splitter Cables

Use CSRB-M1250M125.47M125.73 to split power between two *FlexPower* or solar powered devices. DO NOT use this cable to connect a *FlexPower* devices to a 10 to 30 V dc powered device.

Use CSRB-M1253.28M1253.28M1253.28 to connect one *FlexPower* device (data radio, *FlexPower* Gateway, etc) to two power sources, such as the *FlexPower* Solar Supply and DX81P6 Battery Pack.

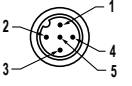
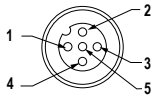
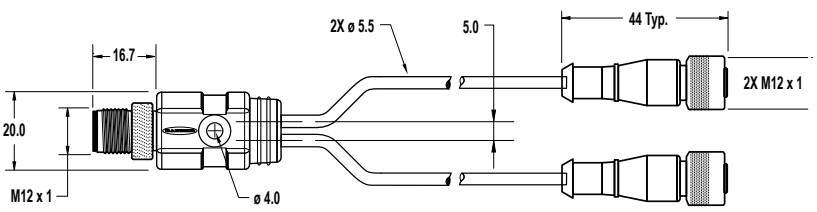
5-Pin Threaded M12/Euro-Style Splitter Cordsets—Rounded Junction			
Model	Length	Style	Pinout
CSRB-M1250M125.47M125.73	Trunk: 0 m (male) Branches: 0.14 m and 0.22 m (female)	Straight	Male 
CSRB-M1253.28M1253.28M1253.28	Trunk: 1 m (female) Branches: 1 m (male)		Female 
			<p>1 = Brown 2 = White 3 = Blue 4 = Black 5 = Gray</p>

Use the following 4-pin splitter cables to split power between two 10 to 30 V dc powered devices, such as a data radio and Gateway, or between a DX85 and Gateway.

4-Pin Threaded M12/Euro-Style Splitter Cordsets—Flat Junction			
Model	Branches (Female)	Trunk (Male)	Pinout
CSB-M1240M1240	No branch	No trunk	
CSB-M1240M1241	2 x 0.30 m (1 ft)	No trunk	
CSB-M1241M1241		0.30 m (1 ft)	
CSB-M1248M1241		2.50 m (8 ft)	
CSB-M12415M1241		4.57 m (15 ft)	
CSB-M12425M1241		7.60 m (25 ft)	
CSB-UNT425M1241		7.60 m (25 ft) unterminated	

<b>BWA-DRSPLITTER</b> <ul style="list-style-type: none"> <li>• Splitter cable, DB9 Female (RS232) trunk to 5-pin M12/Euro-style male and female</li> <li>• Datasheet: <a href="#">155284</a></li> </ul>
---------------------------------------------------------------------------------------------------------------------------------------------------------------------------------------------------------

### 11.6.4 Euro-Style Cordsets - Single Ended

When facing the Node or Gateway toward you and the quick disconnect connection is facing down, the right-angle cables exit to the right.

Right-angle cordsets are not compatible with the DX70 devices. When using the FlexPower Node with integrated battery, use a double ended cordset. For a FlexPower Node with external power supply, use a single ended cordset. If using the **communication** lines, the cable length cannot exceed 3 meters, or 10 feet.

5-Pin Threaded M12/Euro-Style Cordsets—Single Ended				
Model	Length	Style	Dimensions	Pinout (Female)
MQDC1-501.5	0.50 m (1.5 ft)	Straight		
MQDC1-506	1.83 m (6 ft)			
MQDC1-515	4.57 m (15 ft)			
MQDC1-530	9.14 m (30 ft)			
MQDC1-506RA	1.83 m (6 ft)	Right-Angle		
MQDC1-515RA	4.57 m (15 ft)			
MQDC1-530RA	9.14 m (30 ft)			

Models	Description
BWA-QD5.5	Prewired 5-pin M12/Euro-style quick disconnect (QD), 1/2-14 NBSM
BWA-QD8.5	Prewired, 8-pin M12/Euro-style quick disconnect (QD), 1/2-14 NBSM

Models	Description
BWA-QD12.5	Prewired 12-pin M12/Euro-style quick disconnect (QD), 1/2-14 NBSM
FIC-M12F4	4-pin M12/Euro-style straight female field-wireable connector
MODMC-401	300 mm (12 in) cordset with a 4-pin M12/Euro-style straight male quick disconnect (QD), single ended, longer for DX80...C models

### 11.6.5 Euro-Style Cordsets - Double Ended

When using the FlexPower Node with integrated battery, use a double ended cordset. When using a FlexPower Node with external power supply, use a single ended cordset. If using the **communication** lines, the cable length cannot exceed 3 meters (10 ft).

5-Pin Threaded M12/Euro-Style Cordsets—Double Ended and Less Than 3 m Long				
Model	Length	Style	Dimensions	Pinout
DEE2R-51D	0.31 m (1 ft)	Female Straight/ Male Straight		Male
DEE2R-53D	0.91 m (3 ft)			Female
DEE2R-58D	2.44 m (8 ft)			

### 11.6.6 Other Cables

**BWA-RIBBON-001**

- Ribbon cable, 20-pin DBL socket



**BWA-HW-010**

- Cable, FlexPower Current Monitoring

## 11.7 Other Accessories



### 11.7.1 DX85 Modbus RTU Remote I/O Devices

These remote I/O devices have a Modbus interface and are used to expand the I/O of the Gateway or the Modbus host.

Models	Description	
<a href="#">DX85M6P6</a>	DX85 Modbus RTU Remote I/O, 6 Discrete IN, 6 Discrete OUT	 <p>IP67 Housing</p>  <p>IP20 Housing</p>
<a href="#">DX85M4P4M2M2</a>	DX85 Modbus RTU Remote I/O, 4 Discrete IN, 4 Discrete OUT, 2 Analog IN, 2 Analog OUT (0 to 20 mA)	
<a href="#">DX85M4P8</a>	DX85 Modbus RTU Remote I/O, 4 Discrete IN, 8 Discrete OUT	
<a href="#">DX85M8P4</a>	DX85 Modbus RTU Remote I/O, 8 Discrete IN, 4 Discrete OUT	
<a href="#">DX85M0P0M4M4</a>	DX85 Modbus RTU Remote I/O, 4 Analog IN, 4 Analog OUT (0 to 20 mA)	
<a href="#">DX85M-P7</a>	DX85 Modbus RTU Remote I/O, Up to 12 sinking inputs or up to 12 NMOS sinking outputs (for a total of 12 I/O)	
<a href="#">DX85M-P8</a>	DX85 Modbus RTU Remote I/O, Up to 12 sourcing inputs or up to 12 sourcing outputs (for a total of 12 I/O)	

Note: Add a “C” to the end of any DX85 model to order that I/O mix with an IP20 housing. The IP20 models are Class I, Division 2 certified when installed in a suitable enclosure.

### 11.7.2 Cable Glands and Plugs

Models	Description	
BWA-HP.5-10	Dummy Hole Plugs: 1/2-inch NPT, 10 pack	
BWA-HW-031	Vent Plug, 1/2-inch NPT, IP67	
BWA-HW-059	Vent Plug, Plastic, 1/2-inch NPT, Strain-relief fitting, with o-ring, for 0.2 to 0.35 dia cable	
BWA-HW-053	Plug Conduit, Plastic Hex, 1/2-14 NPT, for 1.2 to 2.5 mm dia	
BWA-HW-052	Cable Gland Pack: 1/2-inch NPT gland, 1/2-inch NPT multi-cable gland, and 1/2-inch NPT vent plug	
BWA-CG.5-10	Cable Glands: 1/2-inch NPT, Cordgrips for cable diameters 0.17 to 0.45 inch, 10 Pack	 <p>4</p>
BWA-CG.5-3X5.6-10	Cable Glands: 1/2-inch NPT, Cordgrip for 3 holes of 2.8 to 5.6 mm diam, 10 Pack	
BWA-CG.5-2X2.5-10	Cable Glands: 1/2-inch NPT, Cordgrip for 2 holes of 1.2 to 2.5 mm diam, 10 Pack	
BWA-CG.5-6X4.0-10	Cable Glands: 1/2-inch NPT, Cordgrip for 6 holes of 2 to 4 mm diam, 10 Pack	
BWA-CG.5-6X3.0-10	Cable Glands: 1/2-inch NPT, Cordgrip for 6 holes of 1.5 to 3 mm diam, 10 Pack	





### 11.7.3 Hardware and Replacement Parts

Models	Description
BWA-HW-002	DX80 Access Hardware Kit Plastic threaded plugs, PG-7 (4) Nylon gland fittings, PG-7 (4) Hex nuts, PG-7 (4) Plug, 1/2-inch NPT Nylon gland fitting, 1/2-inch NPT
BWA-HW-003	PTFE Tape, 1/4 inches wide, 600 inches long

4 Shown with PTFE tape wrapping

Models	Description
BWA-HW-004	Replacement Seals O-ring, rotary access cover, PG21 (2) O-ring, body gasket (2) Access cover, rotary dials, clear plastic (2)
BWA-HW-009	Solar assembly hardware pack, includes brackets, bolts, and set screws
BWA-HW-007	Housing Kit, DX80, top and bottom, 10 pieces
BWA-HW-008	Housing Kit, DX81, top and bottom, 10 pieces
BWA-HW-044	Terminal header for the MultiHop Ethernet Data Radio
BWA-HW-011	Terminal Block Headers, IP20, 2 pack
BWA-HW-012	DX99 Antenna Extension Pack Screw, M4-0.7 x 20, pan head, black steel Flexible Antenna Cable, 12 inches, SMA male to SMA female
BWA-HW-032	Access hardware for the E housing, one 1/2-inch plug, one 1/2-inch gland
BWA-HW-037	Clear plastic retaining ring for DX99 metal housings, 10 pack

### 11.7.4 Metal Housing Accessories

<p>BWA-9O2-001</p> <ul style="list-style-type: none"> <li>Dome antenna</li> <li>2 dBi, 18-inch cable, 1/2" SS NPT Port, 900 MHz</li> </ul> <p>BWA-9O2-002</p> <ul style="list-style-type: none"> <li>Dome antenna</li> <li>2 dBi, 18-inch cable, 3/4" SS NPT Port, 900 MHz</li> </ul>		<p>BWA-2O2-001</p> <ul style="list-style-type: none"> <li>Dome antenna</li> <li>2 dBi, 18-inch cable, 1/2" SS NPT Port, 2.4 GHz</li> </ul> <p>BWA-2O2-002</p> <ul style="list-style-type: none"> <li>Dome antenna</li> <li>2 dBi, 18-inch cable, 3/4" SS NPT Port, 2.4 GHz</li> </ul>	
<p>BWA-HW-016</p> <ul style="list-style-type: none"> <li>Antenna Feedthrough, Stainless Steel</li> <li>1/2" NPT</li> </ul> <p>BWA-HW-017</p> <ul style="list-style-type: none"> <li>Antenna Feedthrough, Stainless Steel</li> <li>3/4" NPT</li> </ul>		<p>BWA-AXFS0130</p> <ul style="list-style-type: none"> <li>AXF™ Explosion-Proof Antenna Coupler</li> </ul>	
<p>BWA-HW-012</p> <ul style="list-style-type: none"> <li>DX99 Antenna Extension Pack</li> <li>M4-0.7 x 20 black steel pan head screw</li> <li>Flexible antenna cable 12" SMA male to SMA female</li> </ul>	<p>BWA-HW-037</p> <ul style="list-style-type: none"> <li>Clear plastic retaining ring for DX99 metal housings</li> <li>Qty: 10</li> </ul>		



## 12 Sure Cross® Radio Certifications

Banner's Sure Cross product line is certified by the FCC, European Union, and many other countries for operation within specific radio frequencies.

### 12.1 FCC Certification, 900MHz

The DX80 Module complies with Part 15 of the FCC rules and regulations.

FCC ID: TGUDX80 This device complies with Part 15 of the FCC Rules. Operation is subject to the following two conditions: (1) this device may not cause harmful interference, and (2) this device must accept any interference received, including interference that may cause undesired operation.

#### 12.1 FCC Notices

**IMPORTANT:** The DX80 Modules have been certified by the FCC for use with other products without any further certification (as per FCC section 2.1091). Changes or modifications not expressly approved by the manufacturer could void the user's authority to operate the equipment.

**IMPORTANT:** The DX80 Modules have been certified for fixed base station and mobile applications. If modules will be used for portable applications, the device must undergo SAR testing.

**IMPORTANT:** If integrated into another product, the FCC ID label must be visible through a window on the final device or it must be visible when an access panel, door, or cover is easily removed. If not, a second label must be placed on the outside of the final device that contains the following text: Contains FCC ID: TGUDX80.

#### 12.1 Note

This equipment has been tested and found to comply with the limits for a Class B digital device, pursuant to Part 15 of the FCC Rules. These limits are designed to provide reasonable protection against harmful interference in a residential installation. This equipment generates, uses, and can radiate radio frequency energy and, if not installed and used in accordance with the instructions, may cause harmful interference to radio communications. However, there is no guarantee that interference will not occur in a particular installation. If this equipment does cause harmful interference to radio or television reception, which can be determined by turning the equipment off and on, the user is encouraged to try to correct the interference by one or more of the following measures:

- Reorient or relocate the receiving antenna,
- Increase the separation between the equipment and receiving module,
- Connect the equipment into an outlet on a circuit different from that to which the receiving module is connected, and/or
- Consult the dealer or an experienced radio/TV technician for help.

**Antenna Warning:** This device has been tested with Reverse Polarity SMA connectors with the antennas listed in [Table 3](#) on page 89. When integrated into OEM products, fixed antennas require installation preventing end-users from replacing them with non-approved antennas. Antennas not listed in the tables must be tested to comply with FCC Section 15.203 (unique antenna connectors) and Section 15.247 (emissions).

#### 12.1 FCC Approved Antennas

**WARNING:** This equipment is approved only for mobile and base station transmitting devices. Antenna(s) used for this transmitter must be installed to provide a separation distance of at least 20 cm from all persons and must not be collocated or operating in conjunction with any other antenna or transmitter.

DX80 Module may be used only with Approved Antennas that have been tested with this module.

Table 3: Certified Antennas for 900 MHz

Model Number	Antenna Type	Maximum Gain
	Integral antenna	Unity gain
BWA-901-x	Omni, 1/4 wave dipole	≤2 dBi
BWA-902-C	Omni, 1/2 wave dipole, Swivel	≤2 dBi
BWA-906-A	Omni Wideband, Fiberglass Radome	≤8.2 dBi
BWA-905-B	Omni Base Whip	≤7.2 dBi
BWA-9Y10-A	Yagi	≤10 dBi

### 12.2 FCC Certification, 900 MHz, 1 Watt Radios

The DX80 Module complies with Part 15 of the FCC rules and regulations.

FCC ID: UE3RM1809 This device complies with Part 15 of the FCC Rules. Operation is subject to the following two conditions: (1) this device may not cause harmful interference, and (2) this device must accept any interference received, including interference that may cause undesired operation.

### 12.2 FCC Notices

**IMPORTANT:** The radio modules have been certified by the FCC for use with other products without any further certification (as per FCC section 2.1091). Changes or modifications not expressly approved by the manufacturer could void the user’s authority to operate the equipment.

**IMPORTANT:** The radio modules have been certified for fixed base station and mobile applications. If modules will be used for portable applications, the device must undergo SAR testing.

**IMPORTANT:** If integrated into another product, the FCC ID label must be visible through a window on the final device or it must be visible when an access panel, door, or cover is easily removed. If not, a second label must be placed on the outside of the final device that contains the following text: Contains FCC ID: UE3RM1809.

### 12.2 Note

This equipment has been tested and found to comply with the limits for a Class B digital device, pursuant to Part 15 of the FCC Rules. These limits are designed to provide reasonable protection against harmful interference in a residential installation. This equipment generates, uses, and can radiate radio frequency energy and, if not installed and used in accordance with the instructions, may cause harmful interference to radio communications. However, there is no guarantee that interference will not occur in a particular installation. If this equipment does cause harmful interference to radio or television reception, which can be determined by turning the equipment off and on, the user is encouraged to try to correct the interference by one or more of the following measures:

- Reorient or relocate the receiving antenna,
- Increase the separation between the equipment and receiving module,
- Connect the equipment into an outlet on a circuit different from that to which the receiving module is connected, and/or
- Consult the dealer or an experienced radio/TV technician for help.

**Antenna WARNING:** This device has been tested with Reverse Polarity SMA connectors with the antennas listed in [Table 4](#) on page 90. When integrated into OEM products, fixed antennas require installation preventing end-users from replacing them with non-approved antennas. Antennas not listed in the tables must be tested to comply with FCC Section 15.203 (unique antenna connectors) and Section 15.247 (emissions).

### 12.2 FCC Approved Antennas

**WARNING:** This equipment is approved only for mobile and base station transmitting devices. Antenna(s) used for this transmitter must be installed to provide a separation distance of at least 20 cm from all persons and must not be collocated or operating in conjunction with any other antenna or transmitter.

DX80 Module may be used only with Approved Antennas that have been tested with this module.

Table 4: Certified Antennas for 900 MHz 1 Watt

Model Number	Antenna Type	Maximum Gain	Minimum Required Cable/Connector Loss
-	Integral Antenna	Unity gain	0
BWA-901-x	Omni, 1/4 wave dipole	≤2 dBi	0
BWA-902-C	Omni, 1/2 wave dipole, Swivel	≤2 dBi	0
BWA-906-A	Omni Wideband, Fiberglass Radome	≤8.2 dBi	2.2 dB
BWA-905-B	Omni Base Whip	≤7.2 dBi	1.2 dB
BWA-9Y10-A	Yagi	≤10 dBi	4 dB

### 12.3 FCC Certification, 2.4GHz

The DX80 Module complies with Part 15 of the FCC rules and regulations.

FCC ID: UE300DX80-2400 This device complies with Part 15 of the FCC Rules. Operation is subject to the following two conditions: (1) this device may not cause harmful interference, and (2) this device must accept any interference received, including interference that may cause undesired operation.

### 12.3 FCC Notices

**IMPORTANT:** The DX80 Modules have been certified by the FCC for use with other products without any further certification (as per FCC section 2.1091). Changes or modifications not expressly approved by the manufacturer could void the user’s authority to operate the equipment.

**IMPORTANT:** The DX80 Modules have been certified for fixed base station and mobile applications. If modules will be used for portable applications, the device must undergo SAR testing.

**IMPORTANT:** If integrated into another product, the FCC ID label must be visible through a window on the final device or it must be visible when an access panel, door, or cover is easily removed. If not, a second label must be placed on the outside of the final device that contains the following text: Contains FCC ID: UE300DX80-2400.

### 12.3 Note

This equipment has been tested and found to comply with the limits for a Class B digital device, pursuant to Part 15 of the FCC Rules. These limits are designed to provide reasonable protection against harmful interference in a residential installation. This equipment generates, uses, and can radiate radio frequency energy and, if not installed and used in accordance with the instructions, may cause harmful interference to radio communications. However, there is no guarantee that interference will not occur in a particular installation. If this equipment does cause harmful interference to radio or television reception, which can be determined by turning the equipment off and on, the user is encouraged to try to correct the interference by one or more of the following measures:

- Reorient or relocate the receiving antenna,
- Increase the separation between the equipment and receiving module,
- Connect the equipment into an outlet on a circuit different from that to which the receiving module is connected, and/or
- Consult the dealer or an experienced radio/TV technician for help.

**Antenna Warning:** This device has been tested with Reverse Polarity SMA connectors with the antennas listed in [Table 5](#) on page 91. When integrated into OEM products, fixed antennas require installation preventing end-users from replacing them with non-approved antennas. Antennas not listed in the tables must be tested to comply with FCC Section 15.203 (unique antenna connectors) and Section 15.247 (emissions).

### 12.3 FCC Approved Antennas

**WARNING:** This equipment is approved only for mobile and base station transmitting devices. Antenna(s) used for this transmitter must be installed to provide a separation distance of at least 20 cm from all persons and must not be collocated or operating in conjunction with any other antenna or transmitter.

DX80 Module may be used only with Approved Antennas that have been tested with this module.

*Table 5: Certified Antennas for 2.4 GHz*

Model	Antenna Type	Maximum Gain
	Integral antenna	Unity gain
BWA-202-C	Omni, 1/2 wave dipole, Swivel	≤2 dBi
BWA-205-C	Omni, Collinear, Swivel	≤5 dBi
BWA-207-C	Omni, Coaxial Sleeve, Swivel	≤7 dBi

## 12.4 Certified For Use in the Following Countries

The Sure Cross® radio devices are approved for use in the following countries.

Country	Radio Modules		
	900 MHz (150 mW)	900 MHz (1 Watt)	2.4 GHz (65 mW)
Australia		x *	x
Austria			x
Bahamas, The	x		x
Bahrain, Kingdom of			x
Belgium			x
Brazil			x
Bulgaria			x
Canada	x	x	x
Chile			x
China, People's Republic of			x
Colombia	x		x
Cyprus			x
Czech Republic			x

Country	Radio Modules		
	900 MHz (150 mW)	900 MHz (1 <b>Watt</b> )	2.4 GHz (65 mW)
Denmark			x
Ecuador			x
El Salvador			x
Estonia			x
Egypt			x
Finland			x
France			x
Germany			x
Greece			x
Guatemala	x		x
Hungary			x
Iceland			x
India			x
Ireland			x
Israel			x *
Italy			x
Japan			x
Korea, Republic of (South)			x *
Latvia			x
Liechtenstein			x
Lithuania			x
Luxembourg			x
Malta			x
Mexico	x	x	x
Netherlands			x
New Zealand		x *	x
Norway			x
Oman, Sultanate of			x
Pakistan			x
Panama	x		x
Poland			x
Portugal			x
Romania			x
Russia			x
Saudi Arabia, Kingdom of			x
Singapore			x
Slovakia			x
Slovenia			x
South Africa			x
Spain			x
Sweden			x

Country	Radio Modules		
	900 MHz (150 mW)	900 MHz (1 <b>Watt</b> )	2.4 GHz (65 mW)
Switzerland			x
Taiwan (Republic of China)			x *
Thailand			x
Turkey			x
United Arab Emirates			x
United Kingdom			x
United States of America	x	x	x

\* See country-specific notes below.

Australia and New Zealand—For the 900 MHz 1 Watt radios, only models ending in "-AN" are certified for use.

Bulgaria—Authorization required for outdoor and public service use.

Canada—This Class A digital apparatus meets all requirements of the Canadian Interference Causing Equipment Regulations. Operation is subject to the following two conditions: (1) this device may not cause harmful interference, and (2) this device must accept any interference received, including interference that may cause undesired operation.

Cet appareil numérique de la classe A respecte toutes les exigences du Règlement sur le matériel brouiller du Canada. Le présent appareil numérique n'émet pas de bruits radioélectriques dépassant les limites applicables aux appareils numériques de la Classe A prescrites dans le Règlement sur le brouillage radioélectrique édités par le ministère des Communications du Canada.

France—In Guyane (French Guiana) and La Réunion (Reunion Island), outdoor use not allowed.

Israel—DX80 and DX99 models are certified for the external antenna models only.

Italy—If used outside of own premises, general authorization is required.

Korea—Only models ending in "-KR" are certified for use.

Luxembourg—General authorization is required for public service.

Taiwan—Taiwan is certified to operate specific DX70, DX80, and DX99 models. For a list of specific models, refer to the certificate.

#### 12.4 Additional Statements—900 MHz

This device has been designed to operate with the antennas listed on Banner Engineering's website and having a maximum gain of 9 dBm. Antennas not included in this list or having a gain greater than 9 dBm are strictly prohibited for use with this device. The required antenna impedance is 50 ohms.

To reduce potential radio interference to other users, the antenna type and its gain should be so chosen such that the equivalent isotropically radiated power (EIRP) is not more than that permitted for successful communication.

#### 12.4 Transmit Power Levels

The Sure Cross wireless products were certified for use in these countries using the standard antenna that ships with the product. When using other antennas, verify you are not exceeding the transmit power levels allowed by local governing agencies.

### 12.5 Exporting Sure Cross® Radios

**Exporting Sure Cross® Radios.** It is our intent to fully comply with all national and regional regulations regarding radio frequency emissions. Customers who want to re-export this product to a country other than that to which it was sold must ensure the device is approved in the **destination** country. A list of approved countries appears in the *Radio Certifications* section of the product manual. The Sure Cross wireless products were certified for use in these countries using the antenna that ships with the product. When using other antennas, verify you are not exceeding the transmit power levels allowed by local governing agencies. Consult with Banner Engineering Corp. if the destination country is not on this list.

## 13 Warnings

Install and properly ground a **qualified** surge suppressor when installing a remote antenna system. Remote antenna configurations installed without surge suppressors invalidate the manufacturer's warranty. Keep the ground wire as short as possible and make all ground connections to a single-point ground system to ensure no ground loops are created. No surge suppressor can absorb all lightning strikes; do not touch the Sure Cross® device or any equipment connected to the Sure Cross device during a thunderstorm.

**Exporting** Sure Cross® Radios. It is our intent to fully comply with all national and regional regulations regarding radio frequency emissions. Customers who want to re-export this product to a country other than that to which it was sold must ensure the device is approved in the **destination** country. A list of approved countries appears in the *Radio Certifications* section of the product manual. The Sure Cross wireless products were certified for use in these countries using the antenna that ships with the product. When using other antennas, verify you are not exceeding the transmit power levels allowed by local governing agencies. Consult with Banner Engineering Corp. if the destination country is not on this list.

### 13.1 Banner Engineering Corp. Limited Warranty

Banner Engineering Corp. warrants its products to be free from defects in material and workmanship for one year following the date of shipment. Banner Engineering Corp. will repair or replace, free of charge, any product of its manufacture which, at the time it is returned to the factory, is found to have been defective during the warranty period. This warranty does not cover damage or liability for misuse, abuse, or the improper application or installation of the Banner product.

THIS LIMITED WARRANTY IS EXCLUSIVE AND IN LIEU OF ALL OTHER WARRANTIES WHETHER EXPRESS OR IMPLIED (INCLUDING, WITHOUT LIMITATION, ANY WARRANTY OF MERCHANTABILITY OR FITNESS FOR A PARTICULAR PURPOSE), AND WHETHER ARISING UNDER COURSE OF PERFORMANCE, COURSE OF DEALING OR TRADE USAGE.

This Warranty is exclusive and limited to repair or, at the discretion of Banner Engineering Corp., replacement. IN NO EVENT SHALL BANNER ENGINEERING CORP. BE LIABLE TO BUYER OR ANY OTHER PERSON OR ENTITY FOR ANY EXTRA COSTS, EXPENSES, LOSSES, LOSS OF PROFITS, OR ANY INCIDENTAL, CONSEQUENTIAL OR SPECIAL DAMAGES RESULTING FROM ANY PRODUCT DEFECT OR FROM THE USE OR INABILITY TO USE THE PRODUCT, WHETHER ARISING IN CONTRACT OR WARRANTY, STATUTE, TORT, STRICT LIABILITY, NEGLIGENCE, OR OTHERWISE.

Banner Engineering Corp. reserves the right to change, modify or improve the design of the product without assuming any obligations or liabilities relating to any product previously manufactured by Banner Engineering Corp. Any misuse, abuse, or improper application or installation of this product or use of the product for personal protection applications when the product is identified as not intended for such purposes will void the product warranty. Any modifications to this product without prior express approval by Banner Engineering Corp will void the product warranties. All specifications published in this document are subject to change; Banner reserves the right to modify product specifications or update documentation at any time. Specifications and product information in English supersede that which is provided in any other language. For the most recent version of any documentation, refer to:

[www.bannerengineering.com](http://www.bannerengineering.com).

### 13.2 Contact Us

#### Corporate Headquarters

Address:  
Banner Engineering Corporate  
9714 Tenth Avenue North  
Minneapolis, Minnesota 55441, USA

Phone: +1 763 544 3164  
Website: [www.bannerengineering.com](http://www.bannerengineering.com)

#### Europe

Address:  
Banner Engineering EMEA  
Park Lane Culliganlaan 2F  
Diegem B-1831, Belgium

Phone: +32 (0)2 456 0780  
Website: [www.bannerengineering.com](http://www.bannerengineering.com) (> Global)  
Email: [mail@bannerengineering.com](mailto:mail@bannerengineering.com)

#### Turkey

Address:  
Banner Engineering Turkey  
Barbaros Mah. Uphill Court Towers A Blok D:49  
34746 Bati Ataşehir Istanbul Türkiye

Phone: +90 216 688 8282  
Website: [www.bannerengineering.com.tr](http://www.bannerengineering.com.tr)  
Email: [turkey@bannerengineering.com.tr](mailto:turkey@bannerengineering.com.tr)

#### India

Address:  
Banner Engineering India Pune Head Quarters  
Office No. 1001, 10th Floor Sai Capital, Opp. ICC Senapati Bapat Road  
Pune 411016, India

Phone: +91 (0) 206 640 5624  
Website: [www.bannerengineering.com/in/en.html](http://www.bannerengineering.com/in/en.html)  
Email: [salesindia@bannerengineering.com](mailto:salesindia@bannerengineering.com)

#### Mexico

Address:  
Banner Engineering de Mexico Monterrey Head Office  
Edificio VAO Av. David Alfaro Siqueiros No.103 Col. Valle Oriente C.P.66269  
San Pedro Garza Garcia, Nuevo Leon, Mexico

Phone: +52 81 8363 2714 or 01 800 BANNERE (toll free)  
Website: [www.bannerengineering.com/mx/es.html](http://www.bannerengineering.com/mx/es.html)  
Email: [mexico@bannerengineering.com](mailto:mexico@bannerengineering.com)

Brazil

Address:  
Banner do Brasil  
Rua Barão de Teffé nº 1000, sala 54  
Campos Elíseos, Jundiaí - SP, CEP.: 13208-761, Brasil

Phone: +55 11 2709 9880  
Website: [www.bannerengineering.com.br](http://www.bannerengineering.com.br)  
Email: [brasil@bannerengineering.com](mailto:brasil@bannerengineering.com)

China

Address:  
Banner Engineering Shanghai Rep Office  
Xinlian Scientific Research Building Level 12, Building 2  
1535 Hongmei Road, Shanghai 200233, China

Phone: +86 212 422 6888  
Website: [www.bannerengineering.com.cn](http://www.bannerengineering.com.cn)  
Email: [sensors@bannerengineering.com.cn](mailto:sensors@bannerengineering.com.cn)

Japan

Address:  
Banner Engineering Japan  
Cent-Urban Building 305 3-23-15 Nishi-Nakajima Yodogawa-Ku  
Osaka 532-0011, Japan

Phone: +81 (0)6 6309 0411  
Website: [www.bannerengineering.co.jp](http://www.bannerengineering.co.jp)  
Email: [mail@bannerengineering.co.jp](mailto:mail@bannerengineering.co.jp)

Taiwan

Address:  
Banner Engineering Taiwan  
8F-2, No. 308 Section 1, Neihu Road  
Taipei 114, Taiwan

Phone: +886 (0)2 8751 9966  
Website: [www.bannerengineering.com.tw](http://www.bannerengineering.com.tw)  
Email: [info@bannerengineering.com.tw](mailto:info@bannerengineering.com.tw)

# Index

## A

- antenna
  - remote installation 27
- antenna installation
  - remote 24–27

## B

- bad EE 73
- battery
  - integrated 63
- battery replacement
  - DX80 69
- baud rate 43

## C

- chemical exposure 23
- collocation 24

## E

- ec XX 73
- enclosure 22
- error code
  - RF device time-out 73

## F

- fullscale 45

## G

- gasket
  - main body 68
- ground 23
- ground wire 24–27

## I

- I/O isolation 24–27
- input value 45
- integrated battery 63

## L

- lightning arrester 24–27
- link time-out 74

## M

- mechanical stress 23
- Modbus communication parameters
  - 42, 43
- Modbus time-out
  - error code 73

## N

- network ID 41
- no LCD 73
- null 45

## O

- offset 45
- outdoor installations 22
- overvoltage transients 23

## P

- parity 43
- polling 74
- power
  - 10 to 30V dc 62

## R

- radio link failure 74
- radio time-out 73, 74
- RF device time-out 73

## S

- seasonal changes 24
- setting baud rate 43
- setting parity 43
- setting slave ID 43
- slave ID 43
- span 45
- sunlight exposure 22
- surge suppressors 24–27

## T

- time-out
  - radio 73, 74

## U

- units
  - conversion 45

## V

- vibration 23

## W

- water exposure 22
- weatherproofing 25