

EZ-LIGHT® Touch Gen 2 K50 FDA-Grade Pick-to-Light

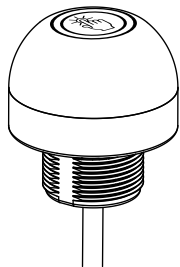

Datasheet

Compact, Single-Point Devices for Error-Proofing of Bin-Picking Operations



- FDA-grade materials; rated to IEC IP67, IP68, and IP69K
- Laser marked information withstands aggressive cleaning procedures
- Excellent immunity to false triggering by water spray, detergents, oils, and other foreign materials
- Rugged, cost-effective and easy-to-install solutions for error-proofing and parts-verification applications
- Compact devices are completely self contained—No controller needed
- Easy actuation—no force required
- 12 V to 30 V dc operation
- Can be actuated with bare hands or in gloves



WARNING: Not To Be Used for Personnel Protection

Never use this device as a sensing device for personnel protection. Doing so could lead to serious injury or death. This device does not include the self-checking redundant circuitry necessary to allow its use in personnel safety applications. A sensor failure or malfunction can cause either an energized or de-energized sensor output condition.

Models

Model ¹	Function	Output	Connection	Job Light
K50APT2FGXDQP	<ul style="list-style-type: none"> • Job light is ON at all times while job input is active • Touch activates output 	PNP, N.O.	150 mm (6 in) PVC cable with a 4-pin M12/Euro-style male, stainless steel, quick disconnect (QD)	Green
K50RPT2FGXDQP		PNP, N.C.		
K50ANT2FGXDQP		NPN, N.O.		
K50RNT2FGXDQP		NPN, N.C.		
K50APT2FGRCQP	<ul style="list-style-type: none"> • Job light is Green while job input is active • Touch activates output and overrides job light (turns Red) for visual verification that action was sensed 	PNP, N.O.		Green (Red)
K50RPT2FGRCQP		PNP, N.C.		
K50ANT2FGRCQP		NPN, N.O.		
K50RNT2FGRCQP		NPN, N.C.		
K50APT2FGREQP	<ul style="list-style-type: none"> • Job light is Green at all times while job input is active • Touch activates output • A touch while job input is inactive causes unit to light Red, providing visual verification that sensor is functioning properly 	PNP, N.O.		Green (Red)
K50RPT2FGREQP		PNP, N.C.		
K50ANT2FGREQP		NPN, N.O.		
K50RNT2FGREQP		NPN, N.C.		

¹ • To order the 2 m (6.5 ft) PVC cable model, omit the suffix "QP" in the model number. For example, K50APT2FGXD.
 • Models with a quick disconnect require a mating cordset.



Specifications

Supply Voltage
12 V to 30 V dc

Supply Current
< 75 mA max current at 12 V dc (exclusive of load)
< 40 mA max current at 30 V dc (exclusive of load)

Supply Protection Circuitry
Protected against reverse polarity and transient voltages

Output Rating
Maximum load: 150 mA
ON-state saturation voltage: < 2 V at 10 mA dc; < 2.5 V at 150 mA dc
OFF-state leakage current: <10 µA at 30 V dc

Output Response Time
50 milliseconds On and Off

Operating Conditions
Temperature: -40 °C to +50 °C (-40 °F to +122 °F)
Humidity: 90% at 50 °C maximum relative humidity (non-condensing)

Storage
-40 °C to +70 °C (-40 °F to +158 °F)

Environmental Rating
IEC IP67, IP69K per DIN 40050-9.

Vibration and Mechanical Shock
Vibration 10 Hz to 55 Hz 1.0 mm p-p amplitude per IEC 60068-2-6
Shock 30G 11 ms duration, half sine wave per IEC 60068-2-27

Power-Up Delay
300 milliseconds

Construction
Base, dome, and nut: FDA-grade polycarbonate

Mounting
M30 x 1.5 Threaded base Max torque 4.5 N·m (40 in·lbf)

Certifications



Indicators
Job ("pick") indicator: Green
Pick sensed indicator: Red or Off, depending on model

Indicator Lumens

Color	Typical Wavelength	Typical Intensity (lm)
Green	525 nm	29
Red	625 nm	13

Connections
150 mm (6 in) PVC cable with a 4-pin M12/Euro-style male, stainless steel, quick disconnect (QD) or 2 m (6.5 ft) unterminated PVC-jacketed cable

Required Overcurrent Protection



WARNING: Electrical connections must be made by qualified personnel in accordance with local and national electrical codes and regulations.

Overcurrent protection is required to be provided by end product application per the supplied table.
Overcurrent protection may be provided with external fusing or via Current Limiting, Class 2 Power Supply.
Supply wiring leads < 24 AWG shall not be spliced.
For additional product support, go to <http://www.bannerengineering.com>.

Supply Wiring (AWG)	Required Overcurrent Protection (Amps)
20	5.0
22	3.0
24	2.0
26	1.0
28	0.8
30	0.5

Dimensions

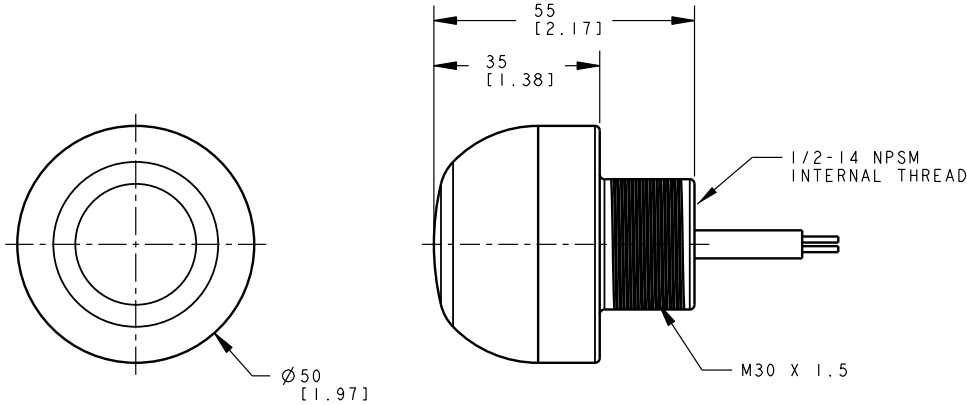

All measurements are listed in millimeters [inches], unless noted otherwise.

Wiring Diagrams

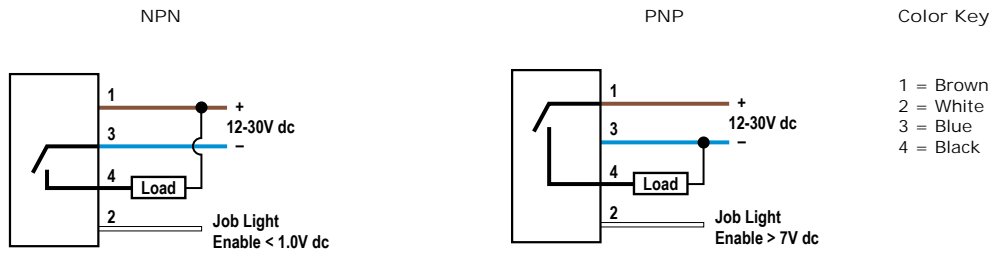

NOTE: Cabled wiring diagrams are shown. Quick disconnect (QD) wiring diagrams are functionally identical.

Accessories

Cordsets

4-Pin Threaded M12/Euro-Style Cordsets				
Model	Length	Style	Dimensions	Pinout (Female)
MQDC-406	1.83 m (6 ft)	Straight		<ul style="list-style-type: none"> 1 = Brown 2 = White 3 = Blue 4 = Black
MQDC-415	4.57 m (15 ft)			
MQDC-430	9.14 m (30 ft)			
MQDC-450	15.2 m (50 ft)			
MQDC-406RA	1.83 m (6 ft)	Right-Angle		
MQDC-415RA	4.57 m (15 ft)			
MQDC-430RA	9.14 m (30 ft)			
MQDC-450RA	15.2 m (50 ft)			

4-Pin Threaded M12/Euro-Style Cordsets—Washdown, Stainless Steel				
Model	Length	Style	Dimensions	Pinout (Female)
MQDC-WDSS-0406	1.83 m (6 ft)	Straight		<ul style="list-style-type: none"> 1 = Brown 2 = White 3 = Blue 4 = Black
MQDC-WDSS-0415	4.57 m (15 ft)			
MQDC-WDSS-0430	9.14 m (30 ft)			

Brackets

SMB30A

- Right-angle bracket with curved slot for versatile orientation
- Clearance for M6 (1/4 in) hardware
- Mounting hole for 30 mm sensor
- 12-ga. stainless steel

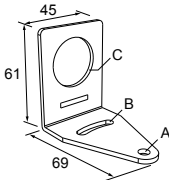

Hole center spacing: A to B=40
 Hole size: A=ø 6.3, B= 27.1 x 6.3, C=ø 30.5

SMB30FA

- Swivel bracket with tilt and pan movement for precise adjustment
- Mounting hole for 30 mm sensor
- 12-ga. 304 stainless steel
- Easy sensor mounting to extrude rail T-slot
- Metric and inch size bolt available

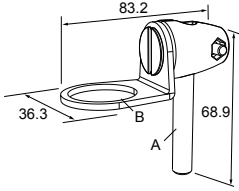

Bolt thread: SMB30FA, A= 3/8 - 16 x 2 in; SMB30FAM10, A= M10 - 1.5 x 50
 Hole size: B= ø 30.1

SMB30FVK

- V-clamp, flat bracket and fasteners for mounting to pipe or extensions
- Clamp accommodates 28 mm dia. tubing or 1 in. square extrusions
- 30 mm hole for mounting sensors

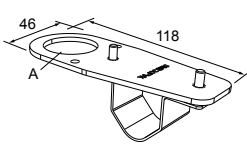

Hole size: A= ø 31

SMB30MM

- 12-ga. stainless steel bracket with curved mounting slots for versatile orientation
- Clearance for M6 (1/4 in) hardware
- Mounting hole for 30 mm sensor

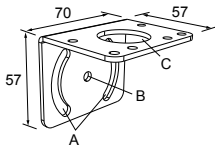

Hole center spacing: A = 51, A to B = 25.4
 Hole size: A = 42.6 x 7, B = ø 6.4, C = ø 30.1

SMB30RAVK

- V-clamp, right-angle bracket and fasteners for mounting sensors to pipe or extrusion
- Clamp accommodates 28 mm dia. tubing or 1 in. square extrusions
- 30 mm hole for mounting sensors

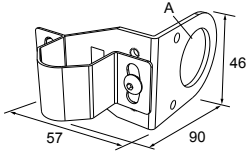

Hole size: A = ø 30.5

SMB30SC

- Swivel bracket with 30 mm mounting hole for sensor
- Black reinforced thermoplastic polyester
- Stainless steel mounting and swivel locking hardware included

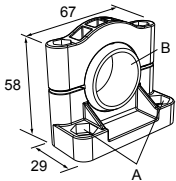

Hole center spacing: A=ø 50.8
 Hole size: A=ø 7.0, B=ø 30.0

SMBAMS30P

- Flat SMBAMS series bracket
- 30 mm hole for mounting sensors
- Articulation slots for 90° + rotation
- 12-ga. 300 series stainless steel

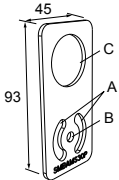

Hole center spacing: A=26.0, A to B=13.0
 Hole size: A=26.8 x 7.0, B=ø 6.5, C=ø 31.0

SMBAMS30RA

- Right-angle SMBAMS series bracket
- 30 mm hole for mounting sensors
- Articulation slots for 90° + rotation
- 12-ga. (2.6 mm) cold-rolled steel

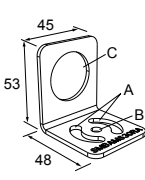

Hole center spacing: A=26.0, A to B=13.0
 Hole size: A=26.8 x 7.0, B=ø 6.5, C=ø 31.0

TC-K50-CL

- Touch cover

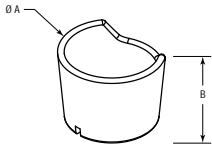

Diameter: A = 67 mm
 Height: B = 42.5 mm

Banner Engineering Corp. Limited Warranty

Banner Engineering Corp. warrants its products to be free from defects in material and workmanship for one year following the date of shipment. Banner Engineering Corp. will repair or replace, free of charge, any product of its manufacture which, at the time it is returned to the factory, is found to have been defective during the warranty period. This warranty does not cover damage or liability for misuse, abuse, or the improper application or installation of the Banner product.

THIS LIMITED WARRANTY IS EXCLUSIVE AND IN LIEU OF ALL OTHER WARRANTIES WHETHER EXPRESS OR IMPLIED (INCLUDING, WITHOUT LIMITATION, ANY WARRANTY OF MERCHANTABILITY OR FITNESS FOR A PARTICULAR PURPOSE), AND WHETHER ARISING UNDER COURSE OF PERFORMANCE, COURSE OF DEALING OR TRADE USAGE.

This Warranty is exclusive and limited to repair or, at the discretion of Banner Engineering Corp., replacement. IN NO EVENT SHALL BANNER ENGINEERING CORP. BE LIABLE TO BUYER OR ANY OTHER PERSON OR ENTITY FOR ANY EXTRA COSTS, EXPENSES, LOSSES, LOSS OF PROFITS, OR ANY INCIDENTAL, CONSEQUENTIAL OR SPECIAL DAMAGES RESULTING FROM ANY PRODUCT DEFECT OR FROM THE USE OR INABILITY TO USE THE PRODUCT, WHETHER ARISING IN CONTRACT OR WARRANTY, STATUTE, TORT, STRICT LIABILITY, NEGLIGENCE, OR OTHERWISE.

Banner Engineering Corp. reserves the right to change, modify or improve the design of the product without assuming any obligations or liabilities relating to any product previously manufactured by Banner Engineering Corp.

Copyright Notice

Any misuse, abuse, or improper application or installation of this product or use of the product for personal protection applications when the product is identified as not intended for such purposes will void the product warranty. Any modifications to this product without prior express approval by Banner Engineering Corp will void the product warranties. All specifications published in this document are subject to change. Banner reserves the right to modify product specifications or update documentation at any time. For the most recent version of any documentation, refer to: www.bannerengineering.com. © Banner Engineering Corp. All rights reserved.