

Installing Your Sure Cross® Radios

Mounting SureCross Devices Outdoors

Use a Secondary Enclosure. For most outdoor applications, we recommend installing your SureCross devices inside a secondary enclosure. For a list of available enclosures, refer to the *Accessories* list.

Point Away From Direct Sunlight. When you are not using a secondary enclosure, minimize the damaging effects of ultra-violet radiation by mounting the devices to avoid facing intense direct sunlight.

- Mount under an overhang or other source of shade,
- Install indoors, or
- Face the devices north when installing outside.

For harsh outdoor applications, consider installing your radio inside a secondary enclosure. For a list of available enclosures, refer to the *Accessories* list.

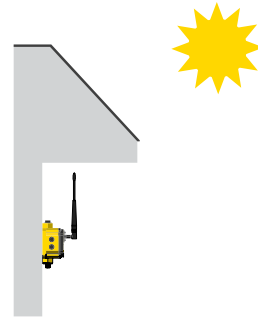

Mount **Vertically** to Avoid **Collecting** Rain. When possible, mount the devices where rain or snow will drain away from the device.

- Mount vertically so that precipitation, dust, and dirt do not accumulate on permeable surfaces.
- Avoid mounting the devices on flat or concave surfaces, especially if the display will be pointing up.

Remove Moisture and Condensation. If condensation is present in any device, add a small desiccant packet to the inside of the radio. To help vent the radios, Banner also sells a vented plug (model number BWA-HW-031) for the 1/2-inch NPT port of the SureCross radios.



Watertight Glands and NPT Ports

To make glands and plugs watertight, use PTFE tape and follow these steps.

1. Wrap four to eight passes of polytetrafluoroethylene (PTFE) tape around the threads as close as possible to the hexagonal body of the gland.
2. Manually thread the gland into the housing hole. Never apply more than 5 in-lbf of torque to the gland or its cable clamp nut. ¹



Seal any unused access holes with one of the supplied plastic plugs. To install a watertight plug:

1. Wrap four to eight passes of PTFE tape around the plug's threads, as close as possible to the flanged surface.
2. Carefully thread the plastic plug into the vacant hole in the housing and tighten using a slotting screwdriver. Never apply more than 10 in-lbf torque to the plastic plug.

If your device has an unused NPT port, install a watertight NPT plug:

1. Wrap 12 to 16 passes of PTFE tape evenly across the length of the threads.
2. Manually thread the plug into the housing port until reaching some resistance.
3. Using a crescent wrench, turn the plug until all the plug's threads are engaged by the housing port or until the resistance doubles. Do not over-tighten as this will damage the device. These threads are tapered and will create a waterproof seal without over-tightening.

¹ This is equivalent to the torque generated without using tools. If a wrench is used, apply only very light pressure. Torquing these fittings excessively damages the device.



Other **Installation** Requirements

Reduce Chemical Exposure

Before installing any devices in a chemically harsh environment, contact the manufacturer for more information regarding the life-expectancy. Solvents, oxidizing agents, and other chemicals will damage the devices.

Minimize Mechanical Stress

Although these radio devices are very durable, they are sophisticated electronic devices that are sensitive to shock and excessive loading.

- Avoid mounting the devices to an object that may be shifting or vibrating excessively. High levels of static force or acceleration may damage the housing or electronic components.
- Do not subject the devices to external loads. Do not step on them or use them as handgrips.
- Do not allow long lengths of cable to hang from the glands on the Gateway or Node. Cabling heavier than 100 grams should be supported instead of allowed to hang from the housing.
- Do not crack the housing by over-tightening the top screws. Do not exceed the maximum torque of 4 in-lbf.

It is the user's responsibility to install these devices so they will not be subject to over-voltage transients. Always ground the devices in accordance with local, state, or national regulations.

When Installing Performance or **MultiHop 1-Watt** Radios

Notice: This equipment must be professionally installed. The output power must be limited, through the use of firmware or a hardware attenuator, when using high-gain antennas such that the +36 dBm EIRP limit is not exceeded.

Installation Quick Tips

The following are some quick tips for improving the installation of wireless network components.

Create a Clear **Communication** Path

Wireless communication is hindered by radio interference and obstructions in the path between the transmitter and receiver. To achieve the best radio performance, carefully consider the installation locations for the Gateways and Nodes and select locations without obstructions in the path.

For more information about antennas, please refer to the *Antenna Basics* reference guide, Banner document p/n 132113.

Increase the Height of the Antennas

Position the external antenna vertically for optimal RF communication. If necessary, consider changing the height of the SureCross radio, or its antenna, to improve reception. For outdoor applications, mounting the antenna on top of a building or pole may help achieve a line-of-sight radio link with the other radios in the network.

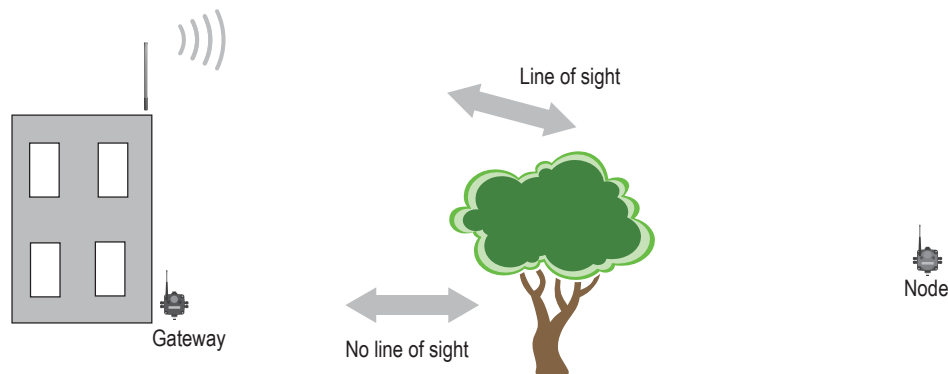

Collocated Radios

When the radio network's master device is located too close to another radio device, communications between all devices is interrupted. For this reason, always assign a unique Network ID to your wireless networks. The Network ID (NID) is a unique identifier you assign to each wireless network to minimize the chances of two collocated networks interfering with each other. Assigning different NIDs to different networks improves collocation performance in dense installations.

Be Aware of Seasonal Changes

When conducting the initial Site Survey, the fewest possible missed packets for a given link is better. However, seasonal changes may affect the signal strength and the total signal quality. Radios installed outside with 50% missed packets in the winter months may have 80% or more missed packets in the summer when leaves and trees interfere with radio reception.

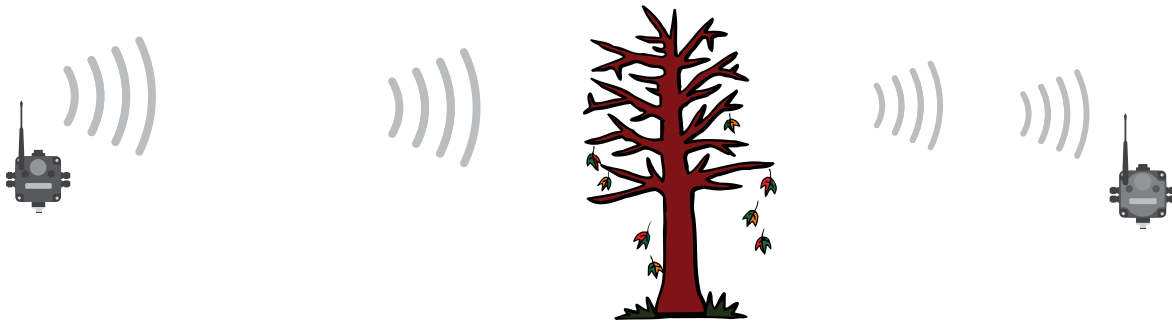

Figure 1. A good signal in winter doesn't always mean you will get the same signal strength the rest of the year.

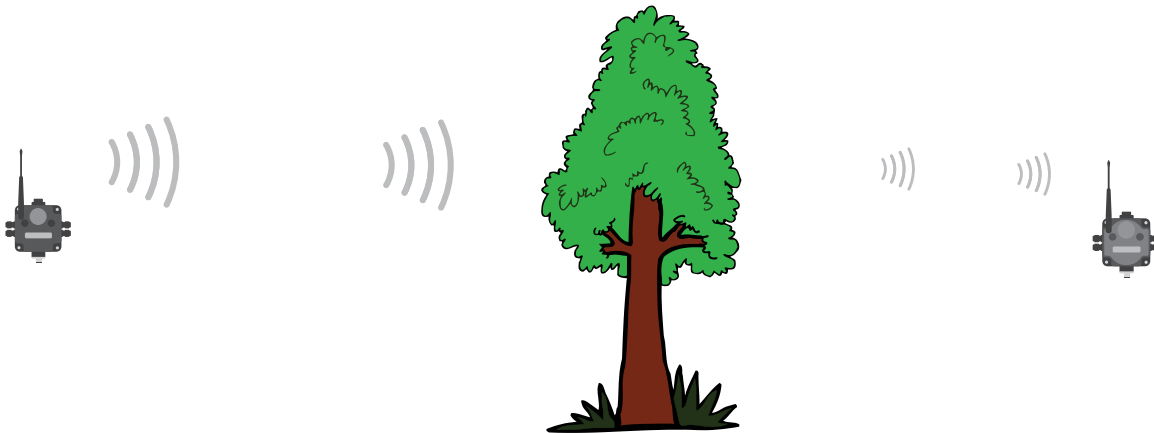

Figure 2. During spring and summer, leaves may block more of the radio signal.

Basic Remote Antenna Installation

A remote antenna system is any antenna system where the antenna is not connected directly to the radio; coaxial cable connects the antenna to the radio.

When installing a remote antenna system, always include a lightning arrestor or coaxial surge suppressor in the system. Remote antenna systems installed without surge protection invalidate the warranty of the radio devices.

Surge suppressors should be properly grounded and mounted at ground level near where the cabling enters a building. Install the surge suppressor indoors or inside a weatherproof enclosure to minimize corrosion or component deterioration. For best results, mount the surge suppressor as close to the ground as possible to minimize the length of the ground connection and use a single-point ground system to avoid creating ground loops.

For more detailed information about how antennas work and how to install them, refer to [Antenna Basics](#) (p/n 132113) (also included as a chapter within the product manual).

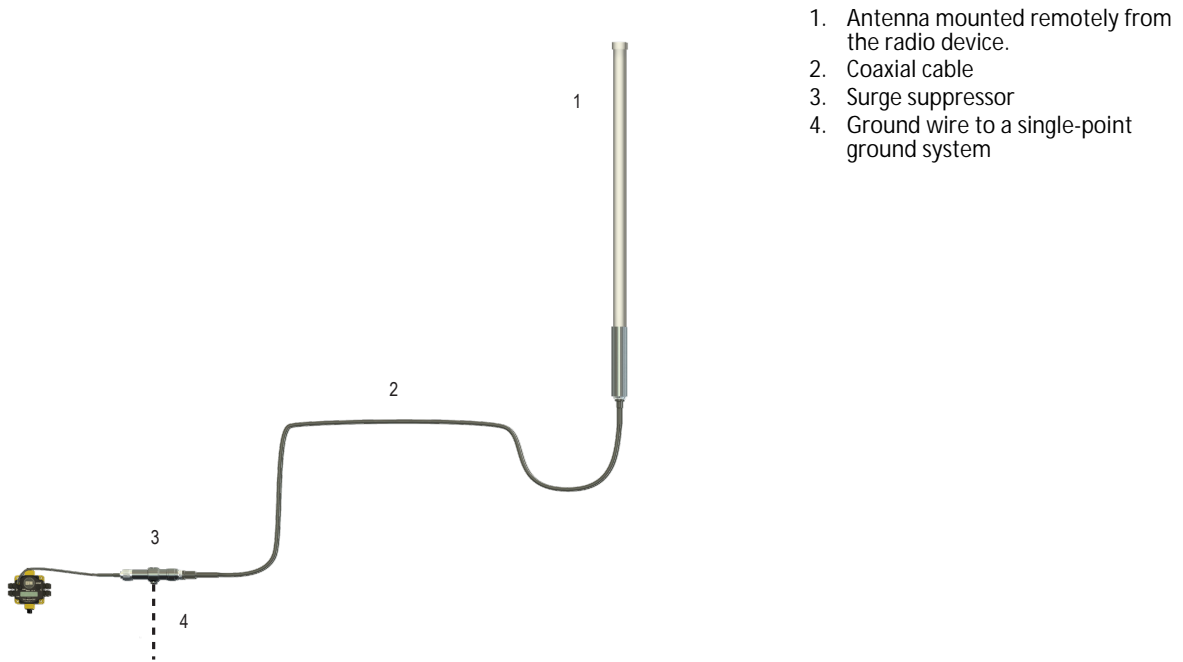

1. Antenna mounted remotely from the radio device.
2. Coaxial cable
3. Surge suppressor
4. Ground wire to a single-point ground system

I/O Isolation. When connecting analog and discrete I/O to external equipment such as VFDs (Variable Frequency Drives), it may be appropriate to install interposing relays and/or loop isolation devices to protect the DX80 unit from transients, noise, and ground plane interference originating from devices or the environment. Contact Banner Engineering Corp. for more information.

Weatherproof Remote Antenna Installations

Seal the connections with rubber splicing tape and electrical tape to prevent water damage to the cable and connections.

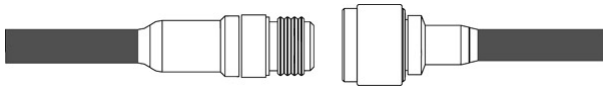

Step 1: Verify both connections are clean and dry before connecting the antenna cable to the antenna or other cable. Hand-tighten the cable connections.

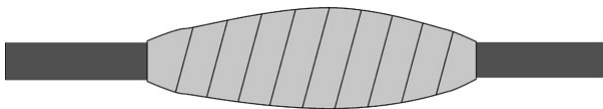

Step 2: Tightly wrap the entire connection with rubber splicing tape. Begin wrapping the rubber splicing tape one inch away from the connection and continue wrapping until you are one inch past the other end of the connection. Each new round of tape should overlap about half the previous round.

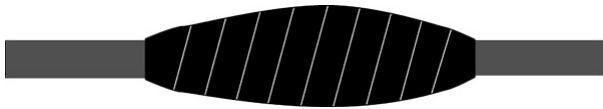

Step 3: Protect the rubber splicing tape from UV damage by tightly wrapping electrical tape on top of the rubber splicing tape. The electrical tape should completely cover the rubber splicing tape and overlap the rubber tape by one inch on each side of the connection.

Installing Remote Antennas

Install and properly ground a **qualified** surge suppressor when installing a remote antenna system. Remote antenna configurations installed without surge suppressors invalidate the manufacturer's warranty. Keep the ground wire as short as possible and make all ground connections to a single-point ground system to ensure no ground loops are created. No surge suppressor can absorb all lightning strikes; do not touch the Sure Cross® device or any equipment connected to the Sure Cross device during a thunderstorm.

Mount a Dome Antenna to the Enclosure

Use a -D dome antenna when mounting an antenna directly to the outside of the enclosure.

1. Dome antenna
2. DIN rail and DIN rail bracket
3. Enclosure

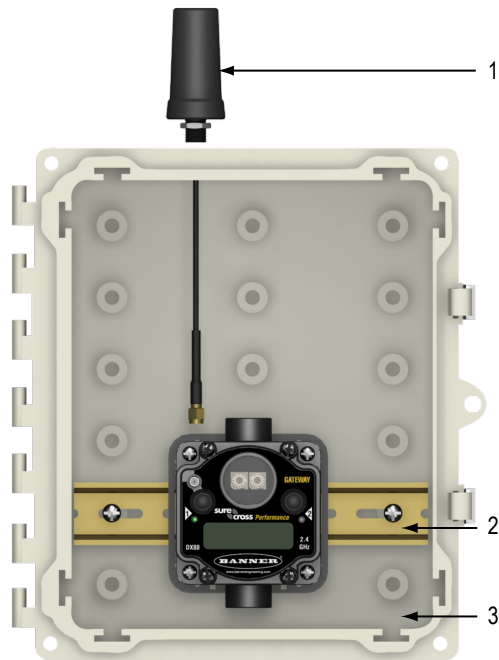

The -D dome antennas come with an 18-inch RP-SMA extension cable connected to the antenna. Use this extension cable to connect the antenna directly to the radio.

To mount, drill a hole in the enclosure and insert the antenna.

Models	Description	List Price
BWA-902-D	Antenna, Omni, 900 MHz, 2 dBd, Dome, RP-SMA MALE Box mount, 18-inch antenna cable	\$95
BWA-202-D	Antenna, Omni, 2.4 GHz, 2 dBd, Dome, RP-SMA MALE Box mount, 18-inch antenna cable	\$95

Use an N-Type, Pole-Mounted Antenna

This antenna mounts remotely from the box, with the SureCross device mounted inside the box.

Ground the surge suppressor and antenna. Keep the ground wire as short as possible and make all ground connections to a single-point ground system to ensure no ground loops are created.

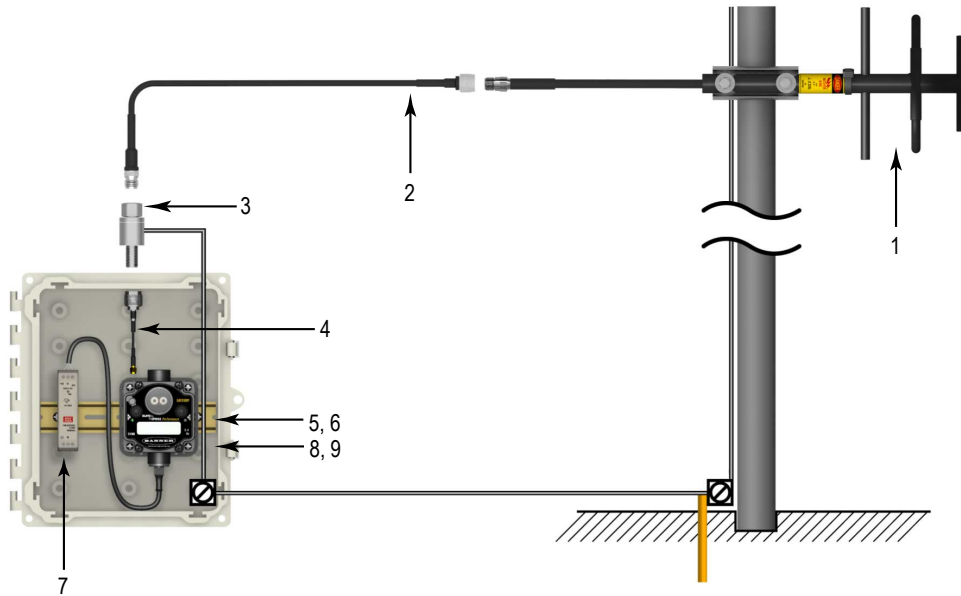



1. N-type Yagi antenna
2. N-Type to N-Type antenna cable
3. Surge suppressor
4. RP-SMA to N-Type male antenna cable
- 5 and 6. DIN rail and DIN rail bracket
7. Power supply
- 8 and 9. Enclosure and enclosure cover/plate, etc

Models	Frequency	Description	List Price
BWA-9Y6-A	900 MHz	6.5 dBd, 6.8 × 13 inches Outdoor	\$135
BWA-9Y10-A		10 dBd, 6.8 × 24 inches Outdoor	\$150

Models	Frequency	Description	List Price
BWA-9O6-A	900 MHz	6 dBd, Fiberglass, Full wave, 71.5 inches	\$355
BWA-2O8-A	2.4 GHz	8.5 dBi, Fiberglass, 24 inches	\$200
BWA-2O6-A		6 dBi, Fiberglass, 16 inches (shown)	\$125
BWA-9O6-AS	900 MHz	6 dBi, Fiberglass, 1/4 Wave, 23.6 inches (1.3 inch dia.)	\$120
BWA-9O8-AS		8 dBi, Fiberglass, 3/4 Wave, 63 inches (1.5 inch dia.)	\$215

Use the LMR400 cables to connect the surge suppressor to the antenna.

Models	Description	List Price
BWC-4MNFN3	LMR400 N-Type Male to N-Type Female, 3 m	\$77
BWC-4MNFN6	LMR400 N-Type Male to N-Type Female, 6 m	\$92
BWC-4MNFN15	LMR400 N-Type Male to N-Type Female, 15 m	\$156
BWC-4MNFN30	LMR400 N-Type Male to N-Type Female, 30 m	\$296

Model	Description	Connection	List Price	
BWC-LMRSFRPB	Surge Suppressor, Bulkhead, RP-SMA Type	RP-SMA to RP-SMA	\$111	
BWC-LFNBMN-DC	Surge Suppressor, bulkhead, N-Type, dc Blocking	N-Type Female, N-Type Male	\$120	

Use the RP-SMA to N-Type male cables to connect the radio to the surge suppressor.

Model	Description	List Price
BWC-1MRSMN05	LMR100 RP-SMA to N-Type Male, 0.5 m	\$40
BWC-1MRSMN2	LMR100 RP-SMA to N-Type Male, 2 m	\$50