

# Sure Cross<sup>®</sup> DXM150-Bx Wireless Controller

## Instruction Manual

Original Instructions  
190038 Rev. A  
21 October 2016  
© Banner Engineering Corp. All rights reserved



190038

# Contents

1 DXM Overview	5
1.1 DXM Automation Protocols	5
1.2 DXM Modbus Overview	5
1.3 DXM Configuration Tool Overview	6
2 DXM Controller	7
2.1 DXM Hardware Configuration Overview	7
3 ISM Radio Board	8
3.1 ISM Radio Board (Modbus Slave ID 1)	8
3.1.1 DIP Switch Settings for the MultiHop HE5 Board Module	8
3.1.2 DIP Switch Settings for the Gateway PEx Board Modules	9
3.2 Binding and Conducting a Site Survey with the ISM Radio	10
3.2.1 Entering Binding Mode	10
3.2.2 Conducting a Site Survey	10
3.3 Modbus Registers for the Gateway Performance 1 Watt Radio	10
3.3.1 Alternative Modbus Register Organization	11
3.4 Modbus Registers for the MultiHop 1 Watt Radio Board	13
4 Processor Board	14
4.1 SAM4 Processor Board	14
4.1.1 DIP Switch Configuration	14
4.1.2 Button Operation	15
4.1.3 LED Operation	15
4.2 Ethernet	15
4.3 USB	15
4.4 Modbus Registers - Internal Local Registers (Modbus Slave 199)	15
4.4.1 Local Registers 1–850 (Internal Processor Memory, 32-bit, Unsigned)	15
4.4.2 Local Registers 851–900 (Data Flash, Non-volatile, 32-bit, Unsigned)	16
4.4.3 Local Registers 1001–1900 (32-bit IEEE Floating Point)	16
4.4.4 Virtual Registers	16
4.4.5 Reset Codes	17
5 I/O Base Board for the DXM150-B1 Models	18
5.1 Board Connections	18
5.1.1 DIP Switches for the I/O Board	18
5.1.2 I/O Board Jumpers	19
5.2 Applying Power to the DXM150-B1 Controller	19
5.2.1 Using the Auxiliary Power Outputs	19
5.2.2 Connecting a Battery to the DXM Wireless Controller	19
5.2.3 Supplying Power from a Solar Panel	20
5.3 Working with Solar Power	20
5.3.1 Setting the DXM Wireless Controller for Solar Power	21
5.3.2 Solar Components	21
5.3.3 Recommended Solar Configurations	22
5.3.4 Monitoring Solar Operation	23
5.4 Connecting the Communication Pins	23
5.4.1 Modbus RTU Master/Modbus RTU Slave	23
5.5 Modbus Master Port and Slave Port	24
5.5.1 Modbus Master and Slave Port Settings	24
5.5.2 Modbus Slave Port ID	25
5.6 Inputs and Outputs	25
5.6.1 Universal Inputs	25
5.6.2 NMOS Outputs	27
5.6.3 Analog Outputs (DAC)	27
5.6.4 Modbus Registers	28
5.7 Restoring Factory Default Settings	31
5.8 Setting the Modbus Slave ID on the I/O Base Board	32
5.8.1 DXM150-Bx Wireless Controller Models	32
5.8.2 Setting the DXM I/O Board Modbus Slave ID using Modbus Registers	33
6 I/O Base Board for the DXM150-B2 Models	34
6.1 Board Connections	34
6.1.1 DIP Switches for the I/O Board	35
6.1.2 I/O Board Jumpers	35
6.2 Applying Power	35
6.2.1 Using the Auxiliary Power Outputs	35
6.2.2 Connecting a Battery to the DXM Wireless Controller	35

6.2.3	Supplying Power from a Solar Panel	36
6.3	Working with Solar Power	37
6.3.1	Setting the DXM Wireless Controller for Solar Power	37
6.3.2	Solar Components	37
6.3.3	Recommended Solar Configurations	38
6.3.4	Monitoring Solar Operation	39
6.4	Connecting the Communication Pins	39
6.4.1	Modbus RTU Master/Modbus RTU Slave	39
6.5	Modbus Master Port and Slave Port	40
6.5.1	Modbus Master and Slave Port Settings	40
6.5.2	Modbus Slave Port ID	41
6.6	Inputs and Outputs	41
6.6.1	Universal Inputs	41
6.6.2	PNP and NPN Outputs	43
6.6.3	Analog Outputs (DAC)	43
6.6.4	Modbus Registers	44
6.7	Restoring Factory Default Settings	47
6.8	Setting the Modbus Slave ID on the I/O Base Board	48
6.8.1	DXM150-Bx Wireless Controller Models	48
6.8.2	Setting the DXM I/O Board Modbus Slave ID using Modbus Registers	49
7	Cellular CDMA	50
7.1	Cellular Modem Board	50
7.2	Cellular Power Requirements	50
7.3	DXM Cellular Modem	50
7.3.1	Configure the DXM Wireless Controller for a Cellular Modem	50
7.3.2	Cellular Activation Quick Start Guide	51
7.3.3	DXM Cellular VPN Setup	52
7.4	Accessing the DXM Using SMS	52
7.4.1	HTTP Push	52
7.4.2	Reboot	52
7.4.3	Get Register	53
7.4.4	Set Register	53
7.4.5	Configuring the DXM Wireless Controller for SMS Controlling	53
8	LCD and Menu System	54
8.1	Registers	54
8.2	Push	54
8.3	ISM Radio	55
8.4	System	56
8.4.1	ISM Radio	56
8.4.2	Ethernet	56
8.4.3	Provision Cell	56
8.4.4	DXM Slave ID	57
8.4.5	Power DC/Solar	57
8.4.6	LCD Contrast	57
8.4.7	Restart	57
8.5	System Info	57
8.6	Using the Display LEDs	58
8.7	Modbus Registers for the LCD Board (Modbus Slave ID 201)	59
9	Working with Modbus Devices	60
9.1	Overview	60
9.2	Assigning Modbus Slave IDs	60
9.3	Modbus Operation	61
9.4	Wireless and Wired Devices	61
9.5	Modbus Timeouts	61
9.5.1	MultiHop Networks vs DX80 Star Networks	62
9.5.2	MultiHop Radios Powered by Battery	62
9.5.3	MultiHop Radios Powered by 10-30 V DC	62
9.5.4	Adjusting the Receive Slots and Retry Count Parameters	62
9.5.5	DX80 Star Architecture Network Timeouts	63
10	Configuration Instructions	64
10.1	Scheduler	64
10.1.1	Creating a Weekly Schedule	64
10.1.2	Defining One-Time Events	64
10.1.3	Creating a Holiday Schedule	65
10.1.4	Cycling Power During Schedules	65
10.2	Authentication Setup	65
10.2.1	Cloud and Webservice Services Authentication	65
10.2.2	Mail Server Authentication	66
10.2.3	DXM Wireless Controller Configuration Authentication	66
10.3	Register Flow and Configuration	67

10.3.1 Basic Approach to Configuration	68
10.3.2 Troubleshooting a Configuration	68
10.3.3 Saving and Loading Configuration Files	68
10.3.4 Uploading or Downloading Configuration Files	68
10.4 Setting Up EtherNet/IP™	69
10.4.1 Configuring the Host PLC	69
10.4.2 Configuring the DXM Wireless Controller	69
10.5 Setting up Email and Text Messaging	69
10.5.1 Define the Network Interface Settings	70
10.5.2 Configure your Ethernet Connection	70
10.5.3 Configure your Cellular Connection	71
10.5.4 Set the Email and Messaging Parameters	71
10.5.5 Define Threshold Rules for Email	72
10.5.6 Define Log File Parameters for Emailing Log Files	72
10.6 Ethernet and Cellular Push Retries	73
10.6.1 Ethernet Push Retries	73
10.6.2 Cellular Push Retries	73
10.6.3 Event/Action Rule or Log File Push Retries	74
10.6.4 Email and Text Message Push Retries	74
10.7 DXM Modbus Registers	74
11 File System and Archive Process	75
11.1 EEPROM Files	75
11.2 Micro SD Card Files	75
12 DXM150 Dimensions	76
13 Contact Us	77
14 Warnings	78
14.1 Banner Engineering Corp. Limited Warranty	78

# 1 DXM Overview

## 1.1 DXM Automation Protocols

---

The DXM Wireless Controller supports the following automation protocols.

**Modbus RTU.** The DXM Wireless Controller manages two separate physical ports running the Modbus RTU protocol. The DXM Wireless Controller is the Modbus Master when operating the Modbus master RTU port. The DXM Wireless Controller uses the master Modbus RTU bus to communicate with locally connected Modbus devices or uses the Banner wireless radio to communicate with remote Modbus devices. The other Modbus RTU port is used by a host system to access the DXM Wireless Controller as a slave device. The slave Modbus RTU port allows access all the internal registers concurrently with the master RTU port. By default, the Modbus RTU ports are active. Configure the port parameters using the DXM Configuration Tool.

**Modbus TCP/IP.** A host system acting as a Modbus client can access the DXM Wireless Controller using the Modbus TCP/IP protocol over Ethernet. Standard Modbus port 502 is used by the DXM Wireless Controller for all Modbus TCP/IP requests. All internal registers are available to the host system concurrently with Modbus RTU. By default, Modbus TCP/IP is active.

**EtherNet/IP™.** The Ethernet port is actively running EtherNet/IP. From the factory the DXM Wireless Controller is configured to read and write registers on DX80 wireless devices 1 through 16. Custom configurations can be set using the DXM Configuration Tool. By default, EtherNet/IP is active.

## 1.2 DXM Modbus Overview

---

The DXM Wireless Controller uses internal 32-bit registers to store information. The processor's internal Local Registers serve as the main global pool of registers and are used as the common data exchange mechanism. External Modbus device registers can be read into the Local Registers or written from the local data registers.

The DXM Wireless Controller, as a Modbus master device or slave device, exchanges data using the Local Registers. Modbus over Ethernet (Modbus/TCP) uses the Local Registers as the accessible register data.

Using Action, Read/Write, and Threshold Rules allows you to manipulate the processor's Local Registers. The ScriptBasic programming capabilities extends the use of Local Registers with variables to create a flexible programming solution for more complex applications.

The processor's Local Registers are divided into three different types: integer, floating point, and non-volatile. When using Local Registers internally, the user can store 32-bit numbers. Using Local Registers with external Modbus devices follows the Modbus standard of a 16-bit holding register. Local Registers are accessible as Modbus ID 199.

Accessing the I/O Base and the LCD follows the same communication as an external Modbus device. Each device has an ID number to uniquely identify itself. The I/O base is Modbus ID 200 and the LCD is Modbus ID 201.

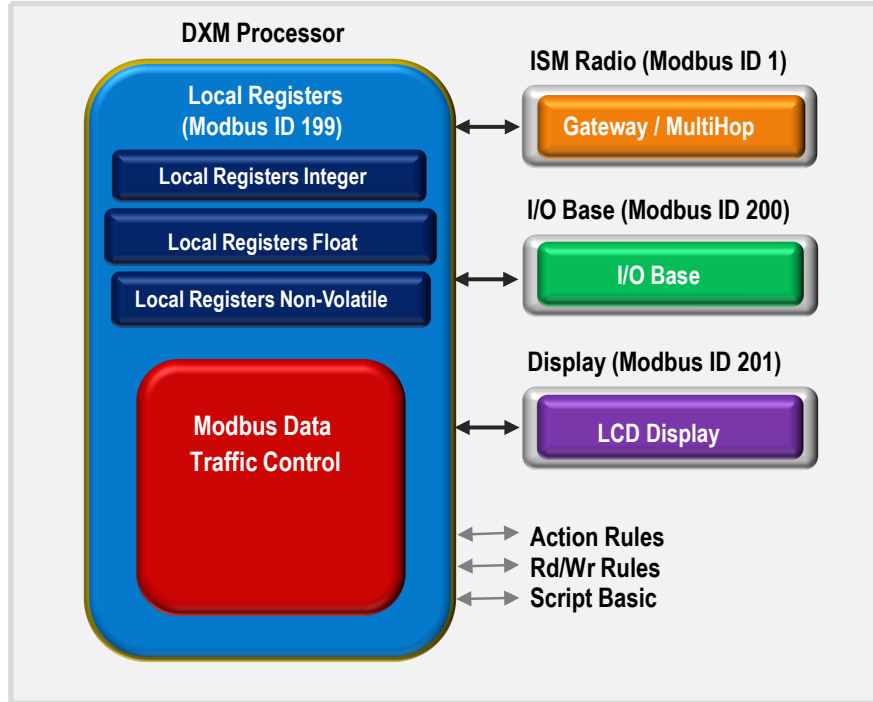

### 1.3 DXM Configuration Tool Overview

The DXM Configuration Tool configures the DXM Wireless Controller by creating an XML file that is transferred to the DXM Wireless Controller using a USB or Ethernet connection. The DXM Wireless Controller can also receive the XML configuration file from a Web server using a cellular or Ethernet connection.

This configuration file governs all aspects of the DXM Wireless Controller operation. The wireless network devices are a separate configurable system. Use the DX80 User Configuration Tool (UCT) to configure the internal DX80 wireless Gateway and the attached wireless Nodes. Use the MultiHop Configuration Tool (MCT) if the internal radio is a MultiHop device.

All tools can be connected to the DXM Wireless Controller using a USB cable or an Ethernet connection.

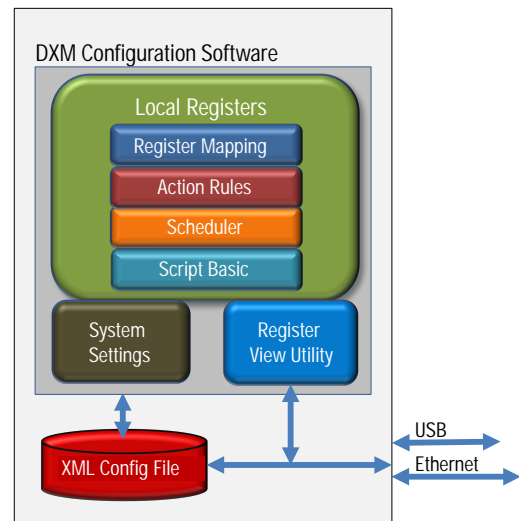

## 2 DXM Controller

### 2.1 DXM Hardware Configuration Overview

The DXM150-Bx Wireless Controller can have multiple configurations. The DXM150-Bx Wireless Controller will have a model number label on the housing. Use the model number and model table above to identify which boards are included in the controller.

When opening the DXM150-Bx Wireless Controller, follow proper ESD grounding procedures. Refer to the ESD warning in the appendix.

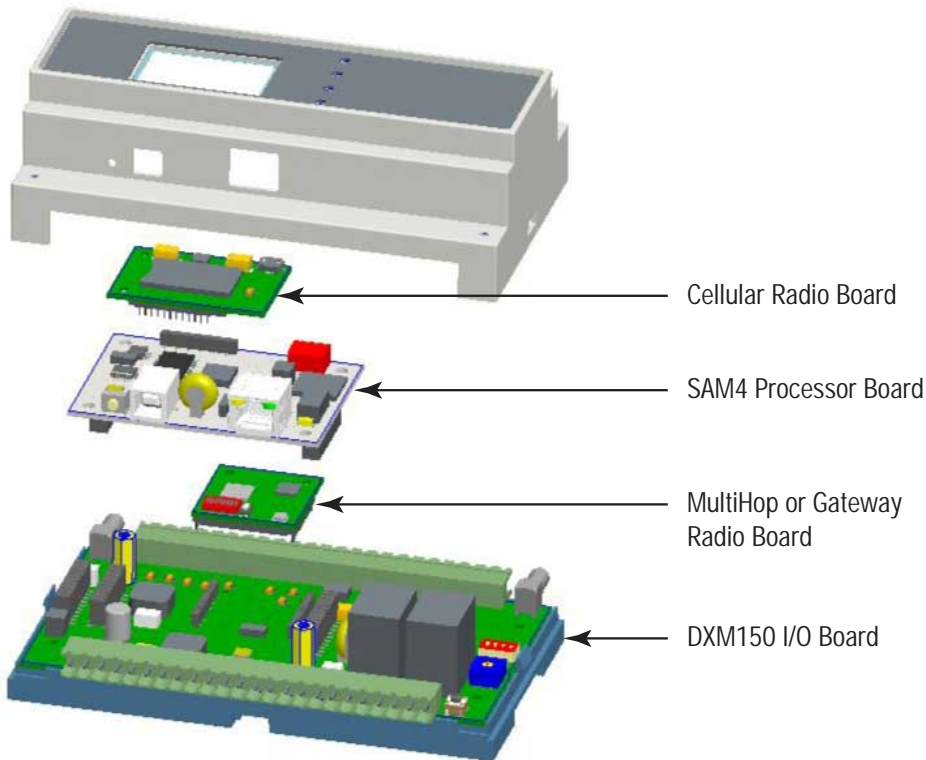

The DXM150-Bx Wireless Controller I/O base board provides connections for all inputs, outputs and power. The base board also contains a 12 V solar controller that accepts connections to a solar panel and SLA battery. The battery connection can also be used with line power to provide a battery backup in case of line power outages.

The ISM radio, either a MultiHop or DX80 Gateway, fits on the base board in the parallel sockets. Install the ISM radio so the U.FL antenna connection is to the side with the SMA antenna connectors. Connect the U.FL cable from the ISM radio U.FL to the right side U.FL connector. The ISM radio boards are available with either a 900 MHz radio or a 2.4 GHz radio.

The SAM4 processor board plugs into the base board using the two 20 pin socket connectors. The board sits above the ISM radio socket and held by the base board standoffs. Position the processor board so the USB and RJ45 Ethernet connection is to the front, away from the SMA antenna connections.

The top plugin PCB is the optional cellular radio. This plugs into the SAM4 processor board with the U.FL antenna connection to the left. Attach the antenna cable from the cellular module to the left U.FL connection on the base board.

The top housing contains the LCD display board. The display board is connected to the base board using a ribbon cable with a 20 pin connector.

In some DXM models, the cellular radio module may be replaced with an ISM radio. The top ISM radio antenna connection will be to the left SMA connector.

## 3 ISM Radio Board

### 3.1 ISM Radio Board (Modbus Slave ID 1)

For the DXM100-S1R2x models, the ISM radio board installed in the I/O board is a MultiHop radio (DX80DR\*M-HE5).

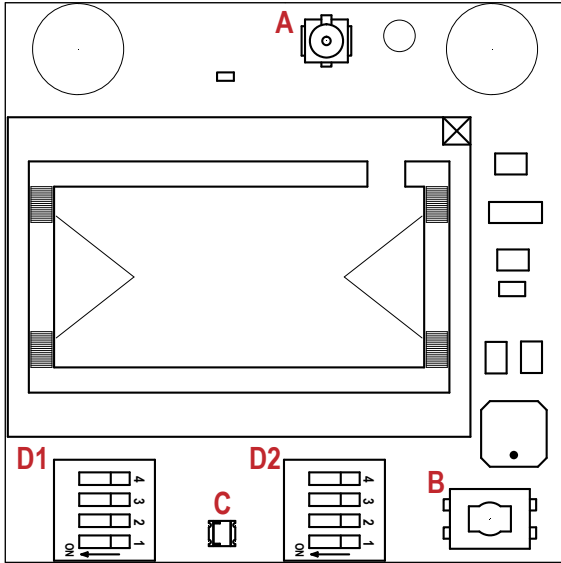

Plug the ISM radio into the I/O base board with the U.FL antenna connector closest to the SMA connectors.

- A - Antenna connector
- B - Button
- C - LED
- D1 - DIP switches
- D2 - DIP Switches

**Button Operation**—For DXM models without a LCD display, use the button (B) to bind the ISM radio. For models with a LCD display, use the ISM menu to bind the radio.

**LED Operation**—The LED located on the ISM radio module indicates power and communications traffic.

- Solid green DX80 ISM radio LED: Indicates power.
- Flashing green MultiHop ISM radio LED indicates operation.
- Red and green combined: Communications traffic and binding.

#### 3.1.1 DIP Switch Settings for the MultiHop HE5 Board Module

Device Settings	D1 Switches				D2 Switches			
	1	2	3	4	1	2	3	4
Serial line baud rate 19200 OR User defined receiver slots	OFF*	OFF*						
Serial line baud rate 38400 OR 32 receiver slots	OFF	ON						
Serial line baud rate 9600 OR 128 receiver slots	ON	OFF						
Serial line baud rate Custom OR 4 receiver slots	ON	ON						
Parity: None			OFF*	OFF*				
Parity: Even			OFF	ON				
Parity: Odd			ON	OFF				
Disable serial (low power mode) and enable the receiver slots select for switches 1-2			ON	ON				
Transmit power 900 MHz radios: 1.00 Watt (30 dBm) 2.4 GHz radios: 0.065 Watts (18 dBm) and 60 ms frame					OFF*			
Transmit power 900 MHz radios: 0.25 Watts (24 dBm) 2.4 GHz radios: 0.065 Watts (18 dBm) and 40 ms frame					ON			



Device Settings	D1 Switches				D2 Switches			
	1	2	3	4	1	2	3	4
Application mode: Modbus						OFF*		
Application mode: Transparent						ON		
MultiHop radio setting: Repeater							OFF*	OFF*
MultiHop radio setting: Master							OFF	ON
MultiHop radio setting: Slave							ON	OFF
MultiHop radio setting: Reserved							ON	ON

\* Default configuration

## Application Mode

The MultiHop radio operates in either Modbus mode or transparent mode. Use the internal DIP switches to select the mode of operation. All MultiHop radios within a wireless network must be in the same mode.

Modbus mode uses the Modbus protocol for routing packets. In Modbus mode, a routing table is stored in each parent device to optimize the radio traffic. This allows for point to point communication in a multiple data radio network and acknowledgement/retry of radio packets. To access a radio's I/O, the radios must be running in Modbus mode.

In transparent application mode, all incoming packets are stored, then broadcast to all connected data radios. The data communication is packet based and not specific to any protocol. The application layer is responsible for data integrity. For one to one data radios it is possible to enable broadcast acknowledgement of the data packets to provide better throughput. In transparent mode, there is no access to the radio's I/O.

## Baud Rate and Parity

The baud rate (bits per second) is the data transmission rate between the device and whatever it is physically wired to. Set the parity to match the parity of the device you are wired to.

## Disable Serial

If the local serial connection is not needed, disable it to reduce the power consumption of a data radio powered from the solar assembly or from batteries. All radio communications remain operational.

## Transmit Power Levels/Frame Size

The 900 MHz data radios can be operated at 1 watt (30 dBm) or 0.250 watt (24 dBm). For most models, the default transmit power is 1 watt.

For 2.4 GHz radios, the transmit power is fixed at 0.065 watt (18 dBm) and DIP switch 5 is used to set the frame timing. The default position (OFF) sets the frame timing to 60 milliseconds. To increase throughput, set the frame timing to 40 milliseconds. Note that increasing the throughput decreases the battery life.

*Prior to date code 15341 and radio firmware version 3.6, the frame timing was 40 ms (OFF) or 20 ms (ON).*

### 3.1.2 DIP Switch Settings for the Gateway PEx Board Modules

Transmit Power—The 900 MHz radios transmit at 1 Watt (30 dBm) or 250 mW (24 dBm). While the Performance radios operate in 1 Watt mode, they cannot communicate with the older 150 mW radios. To communicate with 150 mW radios, operate this radio in 250 mW mode. For 2.4 GHz models, this DIP switch is disabled. The transmit power for 2.4 GHz is fixed at about 65 mW EIRP (18 dBm), making the 2.4 GHz Performance models automatically compatible with older 2.4 GHz models.

DIP Switch Bank D1	
DIP Switch 1	
OFF *	1 Watt (30 dBm, 900 MHz models only)
ON	250 mW (24 dBm, 900 MHz models only), DX80 compatibility mode

\* Default configuration

## 3.2 Binding and Conducting a Site Survey with the ISM Radio

The DXM Wireless Controller can have an internal MultiHop master radio or DX80 Gateway radio (star architecture) installed. Before the ISM radio can communicate with DX80 Nodes, the DXM Wireless Controller must be bound to the other radios in the wireless network. Use the DXM Wireless Controller LCD menu to bind radios to the internal DXM radio.

The LCD display and the processor applications share the external Modbus connection. If the processor is configured to constantly interact with Modbus, it may cause issues with the LCD display attempting to use the functions of the ISM radio. To alleviate the contention:

- Load a DXM configuration file that slows down the read/write rules.
- Disable the DXM configuration file from loading into the processor by setting DIP switch 4 to ON (on the processor board). Reboot the device. When the processor starts back up, it will not load the configuration file and remains idle. See the DXM100 Controller Instructional Manual (190037) for the processor DIP switch location.

### 3.2.1 Entering Binding Mode

Under the ISM Radio menu, use the down arrow button to highlight the Binding menu. Click ENTER.

The ISM Radio menu is slightly different for the two different types of internal radio. The ISM Type displays 'MultiHop' when the MultiHop radio board is installed and 'DX' when the DX80 star architecture radio board is installed.

Use the up/down arrows to enter the device number to bind to. When binding to devices with rotary dials, the device number has no effect. To bind to devices without rotary dials, the device number is saved as the device Modbus slave ID in the MultiHop network or the Node number in a DX80 network.

After entering binding mode on the DXM Wireless Controller, put the end device into binding mode to execute the binding process. Most end devices enter binding by triple-clicking button 2 on the device. For specific instructions on entering binding for a specific device, refer to the individual datasheet for that device.

To bind more devices, click the back button, change the device number (if needed), then enter binding again.

### 3.2.2 Conducting a Site Survey

Although the MultiHop and DX80 devices are architecturally different, the site survey process is similar when conducted from the DXM LCD menu. From the ISM Radio menu, use the down arrow to highlight the Site Survey menu. Click ENTER.

Use the Up or Down arrows to select the Node number (DX80 network) or Modbus Slave ID (MultiHop network). Click ENTER to run the site survey with that Node or slave.

For a DX80 network, the Gateway controls the site survey and the results display on the LCD. Running Site Survey on a DX80 network does not affect the throughput of the DX80 network.

For a MultiHop network, the master device passes the site survey request to the intended Modbus slave device. The Site Survey runs and the results display on the LCD. Running Site Survey on a MultiHop network stops all network traffic to that device.

## 3.3 Modbus Registers for the Gateway Performance 1 Watt Radio

The DX80 Gateway (PE5) is a star-based architecture device that contains all the Modbus registers for the wireless network within the Gateway. To access any input or output values within the entire wireless network, read the appropriate Modbus register from Gateway.

There are 16 Modbus registers allocated for each device in the wireless network. The first 16 registers (1–16) are allocated for the Gateway, the next 16 (17–32) are allocated for Node 1, the next 16 (33–48) are allocated for Node 2 and so forth. There are no inputs or outputs on the DXM embedded Gateway but the Modbus registers are still allocated for them.

Although only seven Nodes are listed in the table, the Modbus register numbering continues for as many Nodes as are in the network. For example, the register number for Node 10, I/O point 15, is 175. Calculate the Modbus register number for each device using the equation:

$$\text{Register Number} = \text{I/O\#} + (\text{Node\#} \times 16)$$

Table 1: Modbus Holding Registers

I/O Point	Gateway	Node 1	Node 2	Node 3	Node 4	Node 5	Node 6	Node 7
1	1	17	33	49	65	81	97	113
2	2	18	34	50	66	82	98	114

I/O Point	Gateway	Node 1	Node 2	Node 3	Node 4	Node 5	Node 6	Node 7
3	3	19	35	51	67	83	99	115
4	4	20	36	52	68	84	100	116
5	5	21	37	53	69	85	101	117
6	6	22	38	54	70	86	102	118
7	7	23	39	55	71	87	103	119
8	8	24	40	56	72	88	104	120
9	9	25	41	57	73	89	105	121
10	10	26	42	58	74	90	106	122
11	11	27	43	59	75	91	107	123
12	12	28	44	60	76	92	108	124
13	13	29	45	61	77	93	109	125
14	14	30	46	62	78	94	110	126
15	15	31	47	63	79	95	111	127
16	16	32	48	64	80	96	112	128

Example: DX80 Performance Gateway Modbus Register Table

Access all wireless network registers by reading Modbus slave ID 1.

DX80 Device	Slave ID	Modbus Registers
DXM Gateway radio	1	Modbus registers 1–8 are inputs, 9–16 are outputs
Node 1	-	Modbus registers 17–25 are inputs, 26–32 are outputs
Node 2	-	Modbus registers 33–40 are inputs, 41–48 are outputs
Node 3	-	Modbus registers 49–56 are inputs, 57–64 are outputs

### 3.3.1 Alternative Modbus Register Organization

The Sure Cross DX80 Alternative Modbus Register Organization registers are used for reordering data registers to allow host systems to efficiently access all inputs or outputs using a single Modbus command. The register groups include the input/output registers, bit-packed registers, and analog registers. This feature is only available with the Performance models using version 3 or newer of the LCD firmware code.

Name	Modbus Register Address (Dec.)
Inputs and Outputs, in order by device	2201 through 4784
Discrete Bit Packed (Status, Discrete Inputs, Discrete Outputs)	6601 through 6753
Analog Inputs (1-8) and Analog Outputs (1-8)	6801 through 9098

### Input Registers and Outputs Registers

Modbus registers 2201 through 2584 are used to organize all inputs together. In this format, users can sequentially read all input registers using one Modbus message. Modbus registers 4401 through 4784 organize all outputs together to allow users to sequentially write to all outputs registers using one Modbus message.

Inputs (2201–2584)		Outputs (4401–4784)	
Modbus Register Address (Dec)	16-bit Register Value	Modbus Register Address (Dec)	16-bit Register Value
2201–2208	Gateway Inputs 1 through 8	4401–4408	Gateway Outputs 1 through 8
2209–2216	Node 1 Inputs 1 through 8	4409–4416	Node 1 Outputs 1 through 8
2217–2224	Node 2 Inputs 1 through 8	4417–4424	Node 2 Outputs 1 through 8
...	...	...	...
2577–2584	Node 47 Inputs 1 through 8	4777–4784	Node 47 Outputs 1 through 8

Refer to your device's datasheet for a list of the active inputs and outputs. Not all inputs or outputs listed in this table may be active for your system.

### Discrete Bit-Packed Registers

Discrete bit-packed registers include the discrete status registers, discrete inputs, and discrete outputs.

Bit packing involves using a single register, or range of contiguous registers, to represent I/O values.

When networks use similar Nodes to gather data using the same I/O registers for each Node, discrete data from multiple Nodes can be bit packed into a single register on the Gateway. The bit-packed data is arranged by I/O point starting at Modbus register 6601. For example, Discrete IN 1 for all the Nodes in the network is stored in three contiguous 16-bit registers.

The most efficient way to read (or write) discrete data from a SureCross® DX80 Gateway is by using these bit-packed registers because users can read or write registers for all devices using one Modbus message. The following registers contain discrete bit-packed I/O values for the Gateway and all Nodes. Values are stored first for the Gateway, then for each Node in order of Node address.

#### Bit-Packed Device Status Registers

Register Address	Bit Position															
	15	14	13	12	11	10	9	8	7	6	5	4	3	2	1	0
6601	Node 15	Node 14	Node 13	Node 12	Node 11	Node 10	Node 9	Node 8	Node 7	Node 6	Node 5	Node 4	Node 3	Node 2	Node 1	Gateway
6602	Node 31	Node 30	Node 29	Node 28	Node 27	Node 26	Node 25	Node 24	Node 23	Node 22	Node 21	Node 20	Node 19	Node 18	Node 17	Node 16
6603	Node 47	Node 46	Node 45	Node 44	Node 43	Node 42	Node 41	Node 40	Node 39	Node 38	Node 37	Node 36	Node 35	Node 34	Node 33	Node 32

#### Bit-Packed Discrete Input 1

Register Address	Bit Position															
	15	14	13	12	11	10	9	8	7	6	5	4	3	2	1	0
6611	Node 15	Node 14	Node 13	Node 12	Node 11	Node 10	Node 9	Node 8	Node 7	Node 6	Node 5	Node 4	Node 3	Node 2	Node 1	Gateway
6612	Node 31	Node 30	Node 29	Node 28	Node 27	Node 26	Node 25	Node 24	Node 23	Node 22	Node 21	Node 20	Node 19	Node 18	Node 17	Node 16
6613	Node 47	Node 46	Node 45	Node 44	Node 43	Node 42	Node 41	Node 40	Node 39	Node 38	Node 37	Node 36	Node 35	Node 34	Node 33	Node 32

#### Bit-Packed Discrete Output 1

Register Address	Bit Position															
	15	14	13	12	11	10	9	8	7	6	5	4	3	2	1	0
6691	Node 15	Node 14	Node 13	Node 12	Node 11	Node 10	Node 9	Node 8	Node 7	Node 6	Node 5	Node 4	Node 3	Node 2	Node 1	Gateway
6692	Node 31	Node 30	Node 29	Node 28	Node 27	Node 26	Node 25	Node 24	Node 23	Node 22	Node 21	Node 20	Node 19	Node 18	Node 17	Node 16
6693	Node 47	Node 46	Node 45	Node 44	Node 43	Node 42	Node 41	Node 40	Node 39	Node 38	Node 37	Node 36	Node 35	Node 34	Node 33	Node 32

Inputs		Outputs	
Modbus Register Address (Decimal)	Description (Inputs)	Modbus Register Address (Decimal)	Description (Outputs)
6601-6603	Status for all devices		
6611-6613	Input 1 from all devices	6691-6693	Output 1 from all devices
6621-6623	Input 2 from all devices	6701-6703	Output 2 from all devices
6631-6633	Input 3 from all devices	6711-6713	Output 3 from all devices
6641-6643	Input 4 from all devices	6721-6723	Output 4 from all devices
6651-6653	Input 5 from all devices	6731-6733	Output 5 from all devices
6661-6663	Input 6 from all devices	6741-6743	Output 6 from all devices
6671-6673	Input 7 from all devices	6751-6753	Output 7 from all devices
6681-6683	Input 8 from all devices		

Status registers (6601-6603) contain a bit-packed representation defining the devices that are operational in the wireless system.

Input registers from all devices use Modbus registers 6611 through 6683 to organize the least significant bit into a sequential array of registers. The first register contains the least significant bit from the input values for the Gateway through Node 15. The second register contains the input values for Node 16 through Node 31, and the third register contains the input values for Nodes 32 through 47.

For discrete inputs, only the least significant bit is used. For analog inputs, the least significant bit indicates if the analog value is above or below the selected threshold value (when using the threshold parameter). For example, a least significant bit of one (1) indicates the analog value is above the selected threshold value. A least significant bit of zero (0) indicates the analog value is below the threshold value.

Output registers from all devices use Modbus registers 6691 through 6753 to organize the least significant bit into a sequential array of registers. Output 8 (I/O point 16) cannot be written using the discrete format.

### Analog 16-Bit Registers (Registers 6801 through 9098)

The most efficient way to read (or write) analog data from a Gateway is by using these 16-bit analog registers. Most networks consist of similar Nodes reporting data using the same I/O registers for each Node. For this reason, the analog data is arranged by I/O point using Modbus registers 6801 through 9098. For example, Input 1 for Gateway and all Nodes is stored in the first 48 contiguous blocks of 16-bit analog registers, beginning with register 6801.

In this format, users can read a 16-bit holding register for all devices or write to a register for all devices using one Modbus message. Using these registers is the most efficient way to read all status registers, read all analog inputs, or write all analog outputs.

The following registers contain analog I/O values for the Gateway and all Nodes. Values are stored first for the Gateway, then for each Node in order of Node address.

Inputs		Outputs	
Modbus Register Address (Decimal)	Description (Inputs)	Modbus Register Address (Decimal)	Description (Outputs)
6801	Input 1 for Gateway	8001	Output 1 for Gateway
6802	Input 1 for Node 1	8002	Output 1 for Node 1
6803	Input 1 for Node 2	8003	Output 1 for Node 2
...	...	...	...
6951	Input 2 for Gateway	8151	Output 2 for Gateway
6952	Input 2 for Node 1	8152	Output 2 for Node 1
6953	Input 2 for Node 2	8153	Output 2 for Node 2
...	...	...	...
7101	Input 3 for Gateway	8301	Output 3 for Gateway
7102	Input 3 for Node 1	8302	Output 3 for Node 1
7103	Input 3 for Node 2	8303	Output 3 for Node 2
...	...	...	...
7851	Input 8 (Status Register) for Gateway	9051	Output 8 for Gateway
7852	Input 8 (Status Register) for Node 1	9052	Output 8 for Node 1
7853	Input 8 (Status Register) for Node 2	9053	Output 8 for Node 2
...	...	...	...

For example, 6801 contains the input 1 value for the Gateway, 6802 contains the input 1 value for Node 1, and 6848 contains the input 1 value for Node 47.

## 3.4 Modbus Registers for the MultiHop 1 Watt Radio Board

The DX80 MultiHop master radio (HE5) is a tree-based architecture device that allows for repeater radios to extend the wireless network. Each device in a MultiHop network is a Modbus device with a unique Modbus ID. Modbus registers in a MultiHop network are contained within each individual radio device. To get Modbus register data from a MultiHop device, configure the DXM Wireless Controller to access each device across the wireless network as an individual Modbus slave device.

Example: MultiHop Modbus Register Table  
 Example MultiHop Modbus registers with generic devices.

MultiHop Device	Slave ID	Modbus Registers
DXM Master radio	1	none
Slave device	11	Modbus register 1–16 are inputs, 501–516 are outputs
Repeater device	12	Modbus register 1–16 are inputs, 501–516 are outputs
Slave device	15	Modbus register 1–16 are inputs, 501–516 are outputs

## 4 Processor Board

### 4.1 SAM4 Processor Board

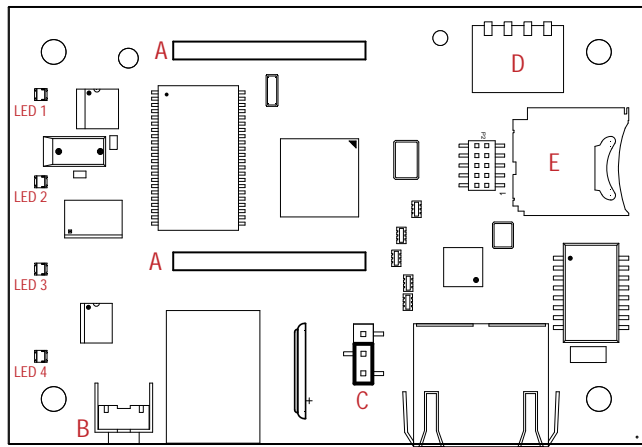

- A - Cellular radio connection
- B - Force cloud push/Clear password
- C - Boot load jumpers
- D - DIP switches
- E - Micro SD card

**Cellular Radio Connection.** Install the cellular modem onto the SAM4 board with the cellular modem's U.FL connector on the left. The antenna cable will go between the cellular U.FL connector and the left I/O board U.FL connector. Only install/remove a cellular modem when the power to the device is disconnected.

**Force Cloud Push button.** Press and hold this button for two seconds to send an immediate push message from the device (if properly configured).

**Clear Password.** By default, the DXM Wireless Controller does not require a password to load a configuration file. If a password is defined, the DXM Wireless Controller requires that you enter the password before uploading a configuration file. To change the password, you must already know the current password. If you do not know the current password, clear the password from the DXM Wireless Controller.



**CAUTION:** Clearing the password erases the current configuration and any program files, log files, or history files currently on the DXM Wireless Controller.

Follow these steps to clear the password requirement from your DXM Wireless Controller.

1. Turn off the power.
2. Set DIP switch 4 to the ON position.
3. Press and hold button 'B'.
4. Apply power to the device.
5. After leaving the device powered on for a few seconds, turn off the power again.
6. Set DIP switch 4 to the OFF position.
7. Reload the configuration file before resuming normal operation.

The password is cleared from the system.

#### 4.1.1 DIP Switch Configuration

Cycle power to the device after making any changes to the DIP switch settings.

Settings	DIP Switches			
	1	2	3	4
Disable Ethernet Port	OFF *			
	ON			
Disable LCD Display		OFF *		
		ON		
Not used			OFF *	
Bypass XML				OFF *

Settings	DIP Switches			
	1	2	3	4
				ON

#### Bypass XML

Turn to ON to have the XML file ignored at boot time. This is useful for ignoring a corrupt or questionable XML configuration file. After the device is running, a new XML file can be loaded using the DXM configuration tool. The factory default position is OFF.

#### Disable Ethernet Port

Set to ON to power down the Ethernet interface. The factory default position is OFF.

#### Disable LCD Display

Set to ON to disable the LCD. This DIP switched should be ON when the LCD display board is not connected. The factory default position is OFF.

### 4.1.2 Button Operation

The SAM4 processor button has two functions:

- Clearing the access password as explained above.
- Pressing the button for 5 seconds forces a Push to the webserver. This assumes a proper configuration for the webserver.

### 4.1.3 LED Operation

By default, the four LEDs indicate the following conditions:

- LED 1 - Heartbeat, indicates the processor is running.
- LED 2 - Indicates the cellular modem power cutoff is active. If the incoming power is less than 11.2 V, the cellular modem is powered down.
- LED 3 - XML configuration file was rejected.
- LED 4 - ScriptBasic program failed to load.

## 4.2 Ethernet

Before applying power to the DXM150-Bx Wireless Controller, verify the Ethernet cable is connected. If the Ethernet cable is not connected when the device powers up, the DXM150-Bx Wireless Controller will not recognize the connection.

The Ethernet connection supports the DXM Configuration Tool, Modbus/TCP, and EtherNet/IP. ScriptBasic also has access to Ethernet for custom programming. Use the DXM Configuration Tool to configure the characteristics of the Ethernet connection, fixed IP addresses, DHCP, etc. The LCD menu allows the user to change the IP Address.

## 4.3 USB

The USB port is used with the DXM Configuration Tool to program the DXM150-Bx Wireless Controller. The USB port is also used as the console output for the processor and ScriptBasic.

## 4.4 Modbus Registers - Internal Local Registers (Modbus Slave 199)

The main storage elements for the DXM Wireless Controller are its Local Registers, which can store 4-byte values that result from register mapping, action rules, or ScriptBasic commands.

- Local Registers 1 through 850 are standard 32-bit signed registers.
- Local Registers 851 through 900 are non-volatile registers that are limited to 100,000 write cycles.
- Local Registers 1001 through 1900 are floating point format numbers. Each register address stores half of a floating point number. For example, registers 1001 and 1002 store the first full 32-bit floating point number.
- Local Registers 10001 through 19000 are system, read-only, registers that track DXM Wireless Controller data and statistics.

### 4.4.1 Local Registers 1–850 (Internal Processor Memory, 32-bit, Unsigned)

The local registers are the main global pool of registers. Local registers are used as basic storage registers and as the common data exchange mechanism.

Modbus slave ID 0 is reserved for the processor.

External Modbus device registers can be read into the local registers or written from the local registers. The DXM Wireless Controller, as a Modbus master device or a Modbus slave device, exchanges data using the local registers.

Modbus over Ethernet (Modbus/TCP) uses the local registers as the accessible register data.

#### 4.4.2 Local Registers 851–900 (Data Flash, Non-volatile, 32-bit, Unsigned)

The top 50 local registers are special non-volatile registers. The registers can store constants or calibration type data that must be maintained when power is turned off.

This register data is stored in a data flash component that has a limited write capability of 100,000 cycles, so these registers should not be used as common memory registers that change frequently.

#### 4.4.3 Local Registers 1001–1900 (32-bit IEEE Floating Point)

These local registers are paired together to store a 32-bit IEEE floating point format number in big endian format.

Registers 1001 [31:16], 1002 [15:0] store the first floating point value; registers 1003, 1004 store the second floating point number. There are a total of 500 floating point values; they are addressed as two 16-bit pieces to accommodate the Modbus protocol.

Use these registers when reading/writing external devices that require Modbus registers in floating point format. Since Modbus transactions are 16-bits, the protocol requires two registers to form a 32-bit floating point number.

#### 4.4.4 Virtual Registers

The DXM Wireless Controller has a small pool of virtual registers that show internal variables of the main processor. Some register values will be dependent upon the configuration settings of the DXM Wireless Controller.

Do not use Read Rules to move Virtual Local Registers data into Local Registers. Use the Action Rule > Register Copy function to move Virtual Local Registers into Local Registers space (1-850).

Registers	Definition	
10001	GPS latitude direction (N, S, E, W)	GPS Coordinate Data if the DXM is configured to read an external GPS unit.
10002	GPS latitude	
10003	GPS longitude direction (N, S, E, W)	
10004	GPS longitude	
10011–10012	Resync timer	Engineering use
10013–10014	Resync timer rollover	Engineering use
10015–10016	Reboot cause (Restart Codes above)	Reboot Type
10017–10018	Watchdog reset count	Counter to track how many resets have been caused by the Watchdog
10021	IO Board Battery Voltage (mV)	DXM Base I/O board battery / solar charger statistics. Refer to the DXM Instruction Manual for more information.
10022	IO Board Battery Charging Current (mA)	
10023	IO Board Incoming Supply (mV)	
10024	IO Board On board thermistor ( degrees C)	
10025–10026	Http Push SSL Acquires	Statistical counts of connections, disconnections and forced disconnects when the DXM Wireless Controller creates a connection using SSL/TLS (Encrypted connections)
10027–10028	Http Push SSL Releases	
10029–10030	Http Push SSL Forced Releases	
10031–10032	Http Push Attempts	Statistical counts of connections, disconnections and forced disconnects when the DXM controller creates a connection using HTTP non-encrypted
10033–10034	Http Push Successes	
10035–10036	Http Push Failures	
10037–10038	Http Push Last Status	Last DXM Wireless Controller push status
10039–10040	Cellular Strength, BER	Cellular signal strength. Value range: 0–31 0 = –113 dBm or less 1 = –111 dBm 2–30 = –109 dBm through –53 dBm in 2 dBm steps 31 = –51 dBm or greater 99 = not known or not detectable; BER not used
10100	Number of read maps in default	Read Map statistics
10101	Number of read map successes	



Registers	Definition	
10102	Number of read map timeouts	
10103	Number of read map errors	
10104	Read map success streak	
10105	Number of write map successes	Write Map statistics
10106	Number of write map timeouts	
10107	Number of write map errors	
10108	Write map success streak	
10109	Number of passthrough successes	API message passing statistics
10110	Number of passthrough timeouts	
10111	Number of passthrough errors	
10112	Passthrough success streak	
10113	Number of 43 buffer successes	DX80 Gateway automatic messaging buffer statistics
10114	Number of 43 buffer timeouts	
10115	Number of 43 buffer errors	
10116	43 buffer success streak	
11000	Read map success count	Read/Write maps statistics
12000	Write map success count	
13000	Read map timeout count	
14000	Write map timeout count	
15000	Read map error count	
16000	Write map error count	
17000	Read map success streak	
18000	Write map success streak	
19000	Read map is in default	

#### 4.4.5 Reset Codes

The reset codes are in virtual register 11015 and define the condition of the last restart operation.

Code	Definition
0	Undefined
1	Unknown
2	General
3	Brownout
4	Watchdog
5	User
6	Software
7	Return from backup mode

## 5 I/O Base Board for the DXM150-B1 Models

### 5.1 Board Connections

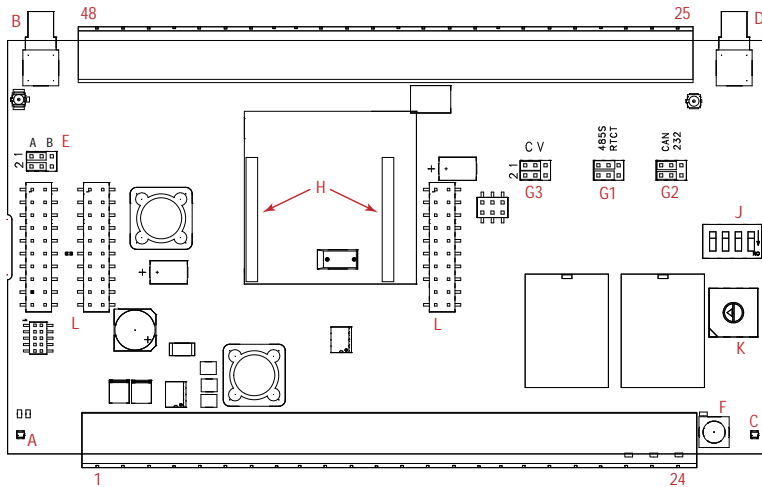

Figure 1. Board Connections

1	NC	17	Input 2B	33	Analog Output 1 (0–20 mA or 0–10 V)
2	12 to 30 V dc or solar power in (+)	18	Ground	34	Ground
3	Ground	19	Output 1 Normally Open	35	PWR Out - Jumper
4	Battery in (< 15 V dc) (must be a sealed lead acid battery)	20	Output 1 Common	36	Ground
5	Ground	21	Output 1 Normally Closed	37	Universal Input 8
6	Primary RS-485 –	22	Output 3 Normally Open	38	Universal Input 7
7	Primary RS-485 +	23	Output 3 Common	39	Universal Input 6
8	Ground	24	Output 3 Normally Closed	40	Universal Input 5
9	RS-232 Tx	25	NMOS Output 5	41	Ground
10	RS-232 Rx	26	No connection	42	Universal Input 4
11	Secondary RS-485 – or RS-232 RXRDY	27	NMOS Output 6	43	Universal Input 3
12	Secondary RS-485 + or RS-232 TXRDY	28	NMOS Output 7	44	Ground
13	Ground	29	No connection	45	PWR Out - Jumper
14	Input 1A	30	NMOS Output 8	46	Universal Input 2
15	Input 1B	31	Ground	47	Universal Input 1
16	Input 2A	32	Analog Output 2 (0–20 mA or 0–10 V)	48	Ground

A	Base Board LED	E	PWR Out Jumpers	G3	Analog Output Characteristics Jumpers (Jumper 1 sets analog out 1, jumper 2 sets analog out 2)
B	Cellular Antenna	F	Radio Binding Button	H	ISM Radio Connection
C	Radio LED	G1	RS-485 Jumpers	J	Modbus Slave ID DIP Switches
D	Radio Module Antenna	G2	RS-232 Jumpers	K	Rotary Dials
				L	SAM4 Processor Board Connection

#### 5.1.1 DIP Switches for the I/O Board

The DXM150-Bx Wireless Controller I/O board DIP switches are set from the factory to Modbus Slave ID 200. For more information, refer to *Setting the Modbus Slave ID on the I/O Base Board*.

### 5.1.2 I/O Board Jumpers

Hardware jumpers on the DXM I/O board allow the user to select alternative pin operations. Turn the power off to the device before changing jumper positions.

Jumper	Function	Positions
E	Analog output characteristics for AO2 (pin 19) and AO1 (pin 20)	<p>Defines current (0–20 mA) or voltage (0–10 V) for analog output 1 and 2.</p> <p>By default, current (0–20 mA) is selected using jumpers 1 and 2 and registers 4008 and 4028 contain a value of 2.</p> <p>To select voltage (0–10 V) for output Aout1, set jumper 1 in the voltage position (V) and set Modbus register 4008 on the I/O board (SID 200) to 3.</p> <p>To select voltage (0–10 V) for output Aout2, set jumper 2 in the voltage position (V) and set Modbus register 4028 on the I/O board (SID 200) to 3.</p>

## 5.2 Applying Power to the DXM150-B1 Controller

Apply power to the DXM Wireless Controller using either 12 to 30 V dc or a 12 V dc solar panel and 12 V sealed lead acid battery.

If the incoming voltage drops below 11.2 V dc, the cellular modem does not turn on and will not turn on until the voltage is above 11.8 V dc. A text file (CmVMon.txt) on the internal micro SD card saves the periodic sampling of the incoming voltage. If cellular operation stops because of voltage, it is logged in this file.

Pin	Description
Pin 1	No connection
Pin 2	12 to 30 V dc input (+) or solar panel connection (+)
Pins 3, 5, 8, 13, 18, 31, 34, 36, 41, 44, 48	Main logic ground for the DXM Wireless Controller
Pin 4	Solar or backup battery positive input. Battery voltage must be less than 15 V dc. Use only a sealed lead acid (SLA) battery.
Pin 35, Pin 45	<p>These outputs are controlled by hardware jumpers.</p> <p>Jumper 2 is the power jumper for pin 45. Jumper 1 is the power jumper for pin 35. Refer to the wiring board for more information.</p> <ul style="list-style-type: none"> <li>The pin 45 jumper selects 2.7 V when in the "a" position and 12 V battery in the "b" position.</li> <li>The pin 35 jumper selects 4.2 V when in the "a" position and device power on pin 2 in the "b" position.</li> </ul>

### 5.2.1 Using the Auxiliary Power Outputs

The DXM150-Bx Wireless Controller has two auxiliary power outputs, pin 35 and pin 45. They are controlled by hardware jumpers on the I/O base board. Refer to the wiring board diagram for more information.

Jumper 2 is the power jumper for pin 45. Jumper 1 is the power jumper for pin 35.

- The pin 45 jumper selects 2.7 V when in the "a" position and 12 V battery in the "b" position.
- The pin 35 jumper selects 4.2 V when in the "a" position and device power on pin 2 in the "b" position.

### 5.2.2 Connecting a Battery to the DXM Wireless Controller

When attaching a battery to the DXM Wireless Controller as a backup battery or as a solar battery, verify the charging algorithm is set properly. The factory default setting for the battery charging algorithm assumes you are using 12 to 30 V dc to recharge the battery.

The charging algorithm is designed to work with a sealed lead acid (SLA) battery only.

- When using 12 to 30 V dc, connect the 12 to 30 V dc + to pin 2 and connect the ground to pin 3.
- When using main dc power with a back up battery (default configuration), connect the incoming main power pin 2 (+) and to pin 3 (-). Connect the 12 V sealed lead acid battery to pin 4 (+) and pin 5 (-). The incoming main power must be 15 to 30 V dc to charge the battery.
- When using a solar panel, connect the solar panel output to pin 2 and connect the ground to pin 3. Connect the 12 V dc SLA battery to pin 4 (+) and pin 5 (-). To change the charging algorithm, refer to [Supplying Power from a Solar Panel](#) on page 20.

Modbus Slave ID	Modbus Register	Description
200 *	6071	Battery backup charging algorithm. 0 = Battery is recharged from a solar panel 1 = Battery is recharged from 12 to 30 V dc (default)

\* The Modbus Slave ID for the base board is set at the factory and may be changed using the base board DIP switch settings.

### 5.2.3 Supplying Power from a Solar Panel

To power the DXM150-Bx Wireless Controller from a 12 V dc solar panel, connect the solar panel to power pins 2(+) and 3(-). Connect a 12 V dc sealed lead acid (SLA) rechargeable battery to pins 4(+) and 5(-).

The factory default setting for the battery charging algorithm assumes you are using 12 to 30 V dc power to recharge the battery. If the incoming power is from a solar panel, you must change the charging algorithm.

To change the charging algorithm from the menu system:

1. From the LCD menu, select Update > Power.
2. Use the up/down arrows to select "SOLAR" power.

To change the charging algorithm by writing to Modbus register 6071 on the I/O base board (Slave ID 200):

1. Write a 0 to select the solar power charging algorithm.

Modbus Slave ID	Modbus Register	Description
200 *	6071	Battery backup charging algorithm. 0 = Battery is recharged from a solar panel 1 = Battery is recharged from 12 to 30 V dc (default)

The following power operating characteristics are stored in Modbus registers.

#### Battery voltage

If no battery is present, the value in this register is less than 5 V. If the value in this register is greater than the incoming voltage register, the battery is powering the system.

#### Battery charging current

The charging algorithm charges the battery when the incoming voltage register value is greater than the battery voltage register value. This registers shows the charging current in milliamps.

#### Incoming supply voltage

The incoming power can be from a solar panel or from a power supply. The battery is charging when the incoming voltage register value is greater than the battery voltage register value. The battery is powering the system when the incoming voltage register value is less than the battery voltage register value.

#### On-board thermistor temperature

This register stores the on-board thermistor reading in tenths of degrees C, this is not a calibrated input: divide by 10 to calculate the temperature in degrees C. For calibrated temperature inputs, define one of the universal inputs as a temperature input.

Modbus Slave ID	Modbus Register	Description
200 *	6081	Battery voltage (mV)
	6082	Battery charging current (mA)
	6083	Incoming supply voltage (mV) (solar or power supply)
	6084	On-board thermistor temperature (°C)

\* The Slave ID for the base board is set at the factory. This may be changed using the base board DIP switch settings.

## 5.3 Working with Solar Power

A reliable solar system requires careful planning and monitoring to size the components correctly. The recommendations provided are for the DXM Wireless Controller system as an autonomous system.

Adding extra components increases the power requirements and likely requires increasing the solar system components. Depending upon the geographical location, the size of the solar panel and battery may vary.

### 5.3.1 Setting the DXM Wireless Controller for Solar Power

By default, the DXM Wireless Controller is set from the factory to charge a backup battery from a line power source. Use the LCD menu on the front of the DXM Wireless Controller to change the charging algorithm to solar power.

Go to System > Power Select. Change the Power to Solar.

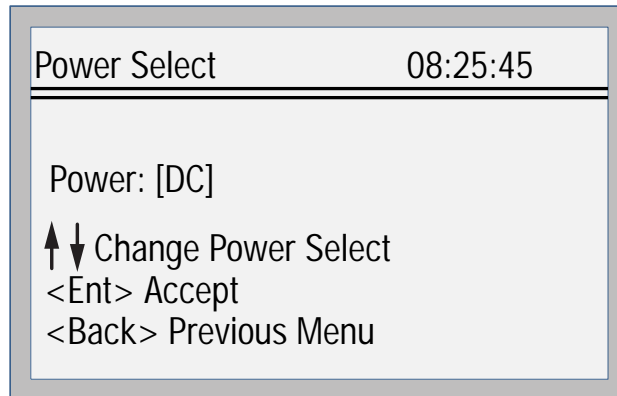

For DXM devices without an LCD, adjust the I/O board Modbus register 6071. Set the register to 0 to select battery charging from a solar panel, and set to 1 to select battery charging from incoming 12 to 30 V dc supply.

Here are a few DXM configuration tips to help minimize the power consumption (may not apply to all models).

- If Ethernet is not being used, save up to 25% of the consumed power by disabling Ethernet. Set DIP switch 1 to the ON position on the processor board then reboot.
- Instead of powering external devices all the time, take advantage of the switched power mechanisms to turn off devices when possible.
- Minimize the number of cellular transactions and the amount of data pushed across the cellular modem.

### 5.3.2 Solar Components

The components of a solar system include the battery and the solar panel.

#### Battery

The DXM solar controller is designed to use a 12 V lead acid battery. The characteristics of a solar system require the battery to be of a certain type. There are basically two types of lead acid batteries:

- SLI batteries (Starting Lights Ignition) designed for quick bursts of energy, like starting engines
- Deep Cycle batteries - greater long-term energy delivery. This is the best choice for a solar battery.

Since a solar system charges and discharges daily, a deep cycle battery is the best choice. There are different versions of a lead acid battery: wet cell (flooded), gel cell, and an AGM (absorbed glass mat).

Wet cell batteries are the original type of rechargeable battery and come in two styles, serviceable and maintenance free. Wet cell batteries typically require special attention to ventilation as well as periodic maintenance but are the lowest cost. The gel cell and AGM battery are sealed batteries that cost more but store very well and do not tend to sulfate or degrade as easily as a wet cell. Gel or AGM batteries are the safest lead acid batteries you can use.

#### Battery Capacity

Battery capacity is a function of the ambient temperature and the rate of discharge. Depending upon the specific battery, a battery operating at -30 °C can have as much as 40 percent less capacity than a battery operating at 20 °C. Choose enough battery capacity based on your geographical location.

A larger capacity battery typically lasts longer for a given solar application because lead-acid batteries do not like deep cycling (discharging a large percentage of its capacity). Depending upon the battery, a battery discharging only 30 percent of its capacity before recharging will have approximately 1100 charge/discharge cycles. The same battery discharging 50 percent of its capacity will have approximately 500 charge/discharge cycles. Discharging 100 percent leaves the battery with only 200 charge/discharge cycles.

Batteries degrade over time based on discharge/charge cycles and environmental conditions. Always monitor the battery system to obtain the best performance of the solar powered system.

Use this as a guide to the approximate state of charge and in determining when to apply conservation measures.

Average Voltage Readings Relative to Battery Change	
State of Charge (%)	Open Circuit Voltage
100	13.0 or higher
75	12.6
50	12.1
25	11.66
0	11.4 or less

## Solar Panel

Banner solar panels come in two common sizes for the DXM Wireless Controller: 5 Watt and 20 Watt. Both panels are designed to work with the DXM Wireless Controller but provide different charging characteristics. Use the 5 watt panel for light duty operation and use the 20 watt panel when you require greater charging capabilities.

Solar Panel	Voltage	Current	Typical DXM Configurations
5 Watt	17 V	0.29 A	DXM slave controller, ISM radio, I/O base board
20 Watt	21 V	1 A	DXM Controller with ISM radio and Cellular modem

Photovoltaic panels are very sensitive to shading. Unlike solar thermal panels, PV solar panels cannot tolerate shading from a branch of a leafless tree or small amounts of snow in the corners of the panel. Because all cells are connected in a series string, the weakest cell will bring down the other cells' power level.

Good quality solar panels will not degrade much from year to year, typically less than 1 percent .

### Solar Panel Mounting

To capture the maximum amount of solar radiation throughout the year, mount a fixed solar panel to optimize the sun's energy throughout the year. For the northern hemisphere, face the panel true south. For the southern hemisphere, face the panel true north. If you are using a compass to orientate the panels, compensate for the difference between true north and magnetic north. Magnetic declination varies across the globe.

A solar panel's average tilt from horizontal is at an angle equal to the latitude of the site location. For optimum performance, adjust the tilt by plus 15 degrees in the winter or minus 15 degrees in the summer. For a fixed panel with a consistent power requirement throughout the year, adjust the tilt angle to optimize for the winter months: latitude plus 15 degrees. Although in the summer months the angle may not be the most efficient, there are more hours of solar energy available.

For sites with snow in the winter months, the increased angle helps to shed snow. A solar panel covered in snow produces little or no power.

## 5.3.3 Recommended Solar Configurations

These solar panel and battery combinations assume direct sunlight for two to three hours a day. Solar insolation maps provide approximate sun energy for various locations. The depth of battery discharge is assumed to be 50 percent.

Solar panel and battery combinations for a DXM Wireless Controller system				
Solar Panel	Battery Capacity <sup>1</sup>	Days of Autonomy	DXM mA	DXM Controller
5 watt	10 Ahr	10 days	25 mA	DXM Slave Controller - ISM radio and I/O base board
20 watt	14 Ahr	10 days	30 mA	DXM Controller with ISM radio
20 watt	20 Ahr	10 days	35 mA	DXM Controller with ISM radio and Cellular Modem

<sup>1</sup> Battery capacity (amp hour) is standard amp rating taken for 20 hours. Battery capacity should be monitored for reliable system power and may need to be increased for cold weather locations.

### 5.3.4 Monitoring Solar Operation

The DXM solar controller provides Modbus registers that allow the user to monitor the state of the solar panel input voltage, the battery voltage, the charging current, and the temperature in °C. The DXM Wireless Controller can be configured to monitor the health of the charging system as well as send an alert message when the battery is too low.

The charts show a typical charging cycle, with each vertical grid representing about eight hours. The chart shows three days of charging.

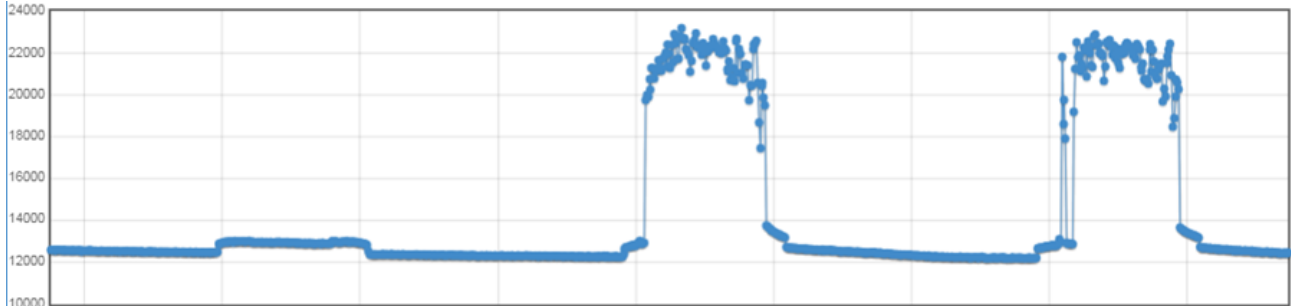

Figure 2. Solar Panel Voltage (mV) -- Cloudy First Day

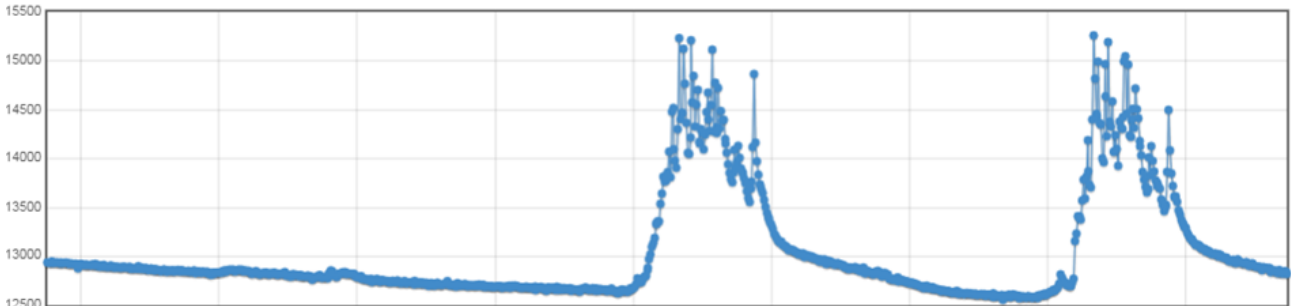

Figure 3. Battery Voltage (mV) - Cloudy First Day

## 5.4 Connecting the Communication Pins

The base board communications connections to the device are RS-485 (primary), RS-485 (secondary) or RS-232.

**RS-485**—The primary RS-485 bus is a common bus shared with the radio board (Modbus Slave ID 1). The DXM150-Bx Wireless Controller is defined as the Modbus Master on this bus. Other internal Modbus slaves include the local processor registers (Modbus Slave ID 199), the base I/O controller (Modbus Slave ID 200), and the display board (Modbus Slave ID 201). When assigning Modbus Slave IDs to externally connected devices, only use IDs 2 through 198.

**RS-232**—The RS-232 bus is not currently defined.

Pin	Parameter	Description
Pin 6	Primary RS-485 –	Running Modbus protocol at 19.2k baud, use this bus to connect to other Modbus Slave devices. The DXM150-Bx Wireless Controller is a Modbus Master device on this RS-485 port.
Pin 7	Primary RS-485 +	
Pin 9	RS-232 Tx	Serial RS-232 connection. This bus must use a ground connection between devices to operate correctly.
Pin 10	RS-232 Rx	
Pin 11	Secondary RS-485 – or RS-232 RXDY	Dual purpose I/O communications pins; select using the RS-485 and RS-232 Selection Jumpers (see <a href="#">Figure 1</a> on page 18). <ul style="list-style-type: none"> <li>In position "a" these pins are a secondary RS-485 bus. The DXM150-Bx Wireless Controller is a Modbus slave on this bus.</li> <li>In position "b" these pins are the flow control signals for the RS-232 signal on pins 9 and 10.</li> </ul>
Pin 12	Secondary RS-485 + or RS-232 TXRDY	

### 5.4.1 Modbus RTU Master/Modbus RTU Slave

The DXM150-Bx Wireless Controller can be a Modbus RTU master device to other slave devices and can be a Modbus slave device to another Modbus RTU master.

The DXM150-Bx Wireless Controller uses the primary RS-485 port as a Modbus RTU master to control external slave devices. The secondary port is the Modbus RTU slave connection.

- As a Modbus RTU master device, the DXM150-Bx Wireless Controller controls external slaves connected to the primary RS-485 port, the local ISM radio, local I/O base board, and the local display board.
- As a Modbus RTU slave device, the DXM150-Bx Wireless Controller local registers can be read from or written to by another Modbus RTU master device.

Use the DXM Configuration Tool to define operational settings for both the Modbus RTU master port and the Modbus RTU slave port.

## 5.5 Modbus Master Port and Slave Port

There are two RS-485 ports on the DXM Wireless Controller, a Modbus master RS-485 port and a Modbus slave RS-485 port.

The Modbus master RS-485 is controlled by the DXM Wireless Controller, which acts as the Modbus master. All wired devices connected to the master RS-485 port must be slave devices.

The Modbus slave RS-485 port is controlled by another Modbus master device, not the DXM Wireless Controller. The slave port is used by other devices that want to access the DXM Wireless Controller as a Modbus slave device. All local registers are available to be read or written from this slave port. Set the Modbus Slave ID for the secondary RS-485 port using the LCD display menu: System > DXM Slave ID.

### 5.5.1 Modbus Master and Slave Port Settings

The basic communications parameters for the RS-485 ports are set in the DXM Configuration Tool and are saved in the XML configuration file. All basic settings are available under Settings > General screen of the DXM Configuration Tool.

Master port parameters include:

- Baud rate and parity
- Set the Communications Timeout parameter to cover the expected time for messages to be sent throughout the wireless network. For the DXM Wireless Controller, the Communications Timeout parameter is the maximum amount of time the DXM Wireless Controller should wait after a request is sent until the response message is received from the Modbus slave device.
- Maximum Polling Rate sets the minimum wait time from the end of a Modbus transaction to the beginning of the next Modbus transaction.

The screenshot shows the 'Settings' screen in the DXM Configuration Tool, with the 'General' tab selected. The interface includes a sidebar with options like 'Local Registers', 'Register Mapping', 'Action Rules', 'Scheduler', 'Register View', and 'Settings'. The main content area is divided into several sections:

- Device Time:** Includes 'Current device time' (displayed as --:--:--), 'Get Time From Device' and 'Synch PC Time with Device' buttons, 'Device timezone (UTC)' set to 'Central Standard Time (UTC-06:00) Central Time (L)', and a 'Device observes DST' checkbox.
- Device Location/GPS:** Includes 'Default latitude' and 'Default longitude' (both set to 0), 'Acquire using' set to 'Default Lat/Lon', 'External GPS address' (set to 0), 'Acquire GPS data every (hh:mm:ss)' (set to 00:00:00), and a 'Send location to cloud' checkbox.
- Modbus Master Communications:** Includes 'Serial mode' (RS-485), 'Baud rate' (19200), 'Parity' (None), 'Communication timeout (hh:mm:ss.fff)' (00:00:05.000), 'Maximum polling rate (hh:mm:ss.fff)' (00:00:00.050), and an 'Enable DX80 polling (43 buffer)' checkbox.
- Modbus Slave Communications:** Includes 'Serial mode' (RS-485), 'Baud rate' (19200), 'Parity' (None), and a 'Wireless Modbus backbone' checkbox.

The Modbus Slave port settings include:

- Baud rate and parity (also set on this screen)
- Set the Modbus Slave port ID using the DXM Wireless Controller LCD
- Set the Wireless Modbus Backbone parameter when there is an ISM radio plugged into the SAM4 processor board and the Modbus slave port is using the MultiHop radio as the slave port instead of the terminal block connection.



### 5.5.2 Modbus Slave Port ID

Set the DXM Modbus slave port using the LCD menu system. On the LCD, use the down arrow to highlight System. Enter the System menu by clicking Enter.

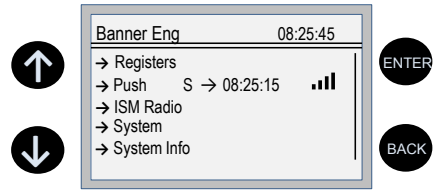

To change the DXM Slave ID, highlight DXM Slave ID, then click Enter.

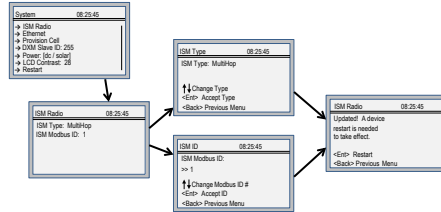

Use the up and down arrow buttons to change the DXM Slave ID.

Press Enter to accept the ID change.

After you change the DXM Slave ID, use the DXM Configuration Tool to cycle power to the device. After cycling power to the device, the updated DXM Slave ID is listed under the System menu.

## 5.6 Inputs and Outputs

The I/O base board is a Modbus slave device (Slave ID 200) that communicates to the processor board using Modbus commands. Use the DXM Configuration Tool to create a configuration using read/write maps that will access inputs or outputs on the I/O board.

Communication with the I/O board runs at a maximum rate of 10 ms per transaction. The parameter setting for the bus with the I/O board and the processor board are fixed. External Modbus communication runs at a maximum rate of 50 ms per transaction. The parameter settings for the external RS-485 buses are controlled by the DXM Configuration Tool.

Refer to the Modbus Registers section for more descriptions of each Modbus register on the DXM150-Bx Wireless Controller.

### 5.6.1 Universal Inputs

The universal inputs can be programmed to accept different types of inputs: discrete NPN/PNP, 0 to 20 mA analog, 0 to 10 V analog, 10k thermistor, potentiometer sense, bridge, and NPN raw fast. Use the DXM Configuration Tool to write to the appropriate Modbus registers in the I/O board to configure the input type.

The universal inputs are treated as analog inputs. When the universal inputs are defined as mA, V, or temperature, use Modbus registers to configure the operational characteristics of the inputs. These parameters are temperature conversion type, enable full scale, threshold and hysteresis. See the Modbus register section for the parameter definitions.

When a universal input is configured as an NPN or PNP input type, it can be enabled to be a synchronous counter. Enable the counter function by setting Modbus register 'Enable Rising' or 'Enable Falling' to 1. See *Modbus Registers* for the universal input register definitions.

Pin	Univ. Input	Description
Pin 47	Universal Input 1	Program the universal inputs to accept input types NPN, PNP, 10k thermistor, 0 to 10 V, 0 to 20 mA, or potentiometer. The default setting is 8: NPN raw fast. To set the input type, write the following values to the Input Type Modbus registers. 0 = NPN 1 = PNP 2 = 0 to 20 mA 3 = 0 to 10 V dc 4 = 10k Thermistor 5 = Potentiometer Sense (DXM150 only) 6 = Not used 7 = Bridge 8 = NPN Raw Fast (default)
Pin 46	Universal Input 2	
Pin 43	Universal Input 3	
Pin 42	Universal Input 4	
Pin 40	Universal Input 5	
Pin 39	Universal Input 6	
Pin 38	Universal Input 7	

Pin	Univ. Input	Description
Pin 37	Universal Input 8	

**Thermistor Input.** A thermistor input must use a 10k thermistor between ground and the universal input. The thermistor must be a 10k NTC (Banner model number BWA-THERMISTOR-002) or equivalent. Select the temperature conversion of degrees C (default) or degrees F by writing to the Modbus registers defined in *I/O Base Board*.

**Potentiometer Sense (DXM150 only).** A potentiometer input is created from two inputs: a voltage source (pin 45) that supplies a voltage to the potentiometer and an input sense (Potentiometer Sense) to read the resistance. Follow [Example: Change Universal Input 8 to Read a Potentiometer Input](#) on page 27 to configure the DXM150 Controller for a potentiometer input.

**Potentiometer Input (DXM100 only).** A potentiometer input is created from three inputs: a voltage source (pin 30) that supplies 5 V to the potentiometer and two inputs set to voltage inputs to read the voltage across the potentiometer. See the DXM technical note for setting up a potentiometer.

**Bridge Input.** The bridge input is not implemented yet.

**NPN vs NPN Raw Fast.** The difference between NPN and NPN Raw Fast is the amount of settling time given to the input. Switch the input type to NPN if the input is not detecting a transition.

### Example: Configure Input 1 as a Synchronous Counter

1. Connect the DXM Wireless Controller to the PC.
2. Launch the DXM Configuration Tool software.
3. Connect to the DXM Wireless Controller by selecting the Device > Connection Settings menu option. You may connect using either USB or Ethernet.
4. Select a COMM port from the drop-down list and click Connect.
5. Click on the Register View tab on the left part of the page.
6. Change the Source Register selection to I/O Board Registers.
7. In the Write Registers area, write Modbus register 4908 to 1 to enable counting on the rising edge of the input signal.
8. Read Modbus registers 4910 and 4911 to get the 32-bit value of the count.

### Example: Change Universal Input 2 to a 0 to 10 V dc Input

1. Connect the DXM Wireless Controller to the PC.
2. Launch the DXM Configuration Tool software.
3. Connect to the DXM Wireless Controller by selecting the Device > Connection Settings menu option. You may connect using either USB or Ethernet.
4. Select a COMM port from the drop-down list and click Connect.
5. Click on the Register View tab on the left part of the page.
6. Change the Source Register selection to I/O Board Registers.
7. Write a 3 to Modbus register 3326 on Modbus Slave ID 200 (I/O board).
8. Cycle power to the device.
9. Using the Register View tab, read register 3326 to verify it is set to 3.

### Example: Change Analog Output 1 to a 0 to 10 V dc Output

1. Connect the DXM Wireless Controller to the PC.
2. Launch the DXM Configuration Tool software.
3. Connect to the DXM Wireless Controller by selecting the Device > Connection Settings menu option. You may connect using either USB or Ethernet.
4. Select a COMM port from the drop-down list and click Connect.
5. Click on the Register View tab on the left part of the page.
6. Change the Source Register selection to I/O Board Registers.
7. Set jumper 1 on the I/O base board to the 0 to 10 V position. Refer to the base board image for the analog output jumper position.
8. Write a 3 to Modbus register 4008 on Modbus Slave ID 200 (I/O board).
9. Cycle power to the device.
10. Using the Register View tab, read register 4008 to verify it is set to 3.

### Example: Change Universal Input 8 to Read a Potentiometer Input

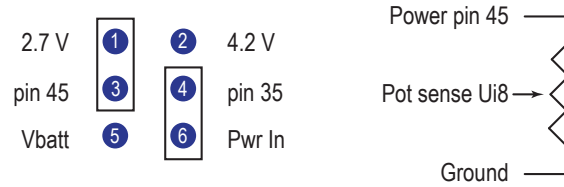

Figure 4. Default jumper position

1. Launch the DXM Configuration Tool tool.
2. Click on the Register View tab on the left part of the page.
3. In the upper right part of the window select Modbus Registers using Modbus Slave ID radio button and enter Modbus Slave ID 200.
4. To set universal input 8 as the sense, write Modbus register 3446 with 5 (Potentiometer Sense).
5. Verify the jumpers are still set to their default position. One jumper should be on pins 1 and 3 to get a 2.7 V source voltage out pin 45. The default position of the other jumper is on pins 4 and 6.
6. Connect one potentiometer side to power output (pin 45), connect the tap point of the pot to universal input 8 (pin 37), and connect the other end of the pot to ground (pin 36).

### 5.6.2 NMOS Outputs

Pin	NMOS Discrete Outputs	Modbus Register	Description	Wiring
22	4	504	Less than 1 A maximum current at 30 V dc ON-State Saturation: Less than 0.7 V at 20 mA ON Condition: Less than 0.7 V OFF Condition: Open	
23	3	503		
24	2	502		
35	1	501		

### 5.6.3 Analog Outputs (DAC)

The following characteristics are configurable for each of the analog outputs.

Pin	Output	Description
Pin 33	Analog Output 1	0 to 20 mA or 0 to 10 V dc output (I/O board jumper selectable) Accuracy: 0.1% of full scale +0.01% per °C Resolution: 12-bit
Pin 32	Analog Output 2	

Parameters for Analog Output 1 start at 4001 through 4008. Parameters for Analog Output 2 start at 4021 through 4028.

Parameter Registers for Analog Outputs (4xxxx)		
OUT 1	OUT 2	Parameters
4001	4021	Maximum Analog Value
4002	4022	Minimum Analog Value
4003	4023	Enable Register Full Scale
4004	4024	Hold Last State Enable
4005	4025	Default Output State
4008	4028	Analog Output Type

**Analog Output Type.** The analog outputs may be configured as either 0 to 20 mA outputs (default) or 0 to 10 V outputs. To change the analog output type change the hardware jumper position and write to the Modbus register that defines the analog output type. For analog output 1, write to Modbus register 4008, for analog output 2 write to Modbus register 4028. Write a value of 2 (default) to select 0 to 20 mA; write a value of 3 to select 0 to 10 V.

**Default Output Conditions.** Default output conditions/triggers are the conditions that drive outputs to defined states. Example default output conditions include when radios are out of sync, when a device cycles power, or during a host communication timeout.

- 2952 Enable Default Communication Timeout. A "communication timeout" refers to the communication between any Modbus master host and the DXM baseboard. Set this register to 1 to enable the default condition when the host has not communicated with the DXM baseboard for the period of time defined by the Communication Default IO Timeout.
- 2953 Communication Default I/O Timeout (100 ms/Count). This parameter defines the host timeout period in 100 millisecond increments. If a host does not communicate within this timeout period, the device outputs are set to the default values.
- 2954 Enable Default on Power Up. Setting this parameter to 1 sends the device outputs to their default condition when the DXM baseboard is powered up. Set to 0 to disable this feature.

**Default Output State.** The Default Output State parameter represents the default condition of the analog output. When an error condition exists, the outputs are set to this 16-bit user-defined output state. To define the error conditions for device outputs, refer to the MultiHop default output parameters 2950-2954.

**Enable Register Full Scale.** Set to 1 to enable a linear range from 0 to 65535 for specified input range. For a 4 to 20 mA output, a value of 0 represents 4 mA and 65535 represents 20 mA. Set this parameter to 0 to store readings in unit-specific data. For example, the register data representing a 15.53 mA reading is 15530. For units of current (0 to 20 mA outputs), values are stored as  $\mu$ A (micro Amps) and voltage values are stored as mV (millivolts).

**Hold Last State Enable.** Set the Hold Last State to 1 to set the output to its last known value before the error occurred. Set this parameter to 0 to disable the Hold Last State and use the Default Output State setting during an error condition.

**Maximum Analog Value.** The Maximum Analog Value register stores the maximum allowed analog value. The specific units of measure apply to the register value. For example, the register may contain 20000, for 20 mA, or for a voltage output the register may contain 8000, for 8 volts.

**Minimum Analog Value.** The Minimum Analog Value register stores the minimum allowed analog value. The specific units of measure apply to register value. For example, the register may contain 4000, for 4 mA, or for a voltage output the register may contain 2000, for 2 volts.

## 5.6.4 Modbus Registers

The DXM150-Bx Wireless Controller may have up to three internal Modbus slave devices:

- Slave ID 1: PE/HE ISM radio socket
- Slave ID 199: Internal Local Registers
- Slave ID 200: I/O base
- Slave ID 201: LCD display board

All Modbus registers are defined as 16-bit Modbus Holding Registers. When connecting external Modbus slave devices, only use Modbus slave IDs 2 through 198. The I/O base and LCD display slave IDs are fixed, but the internal radio slave ID can be changed if needed.

### Internal Local Registers (Slave ID 199)

Registers	Definition
1-450	Local Registers - Internal processor memory
451-500	Local Registers - Data Flash (Non-volatile)
1001-1500	Local Registers - Floating point registers, internal processor memory
10001	GPS latitude direction (N,S,E,W)
10002	GPS latitude
10003	GPS longitude direction (N,S,E,W)
10004	GPS longitude
10011-11012	Resync timer (high, low) (syncing radios)
10013-10014	Resync timer rollover (high, low) (syncing radios)
10015-11016	Reboot Message (high, low) (See restart codes)
10017-11018	Watchdog reset count (high, low)

Registers	Definition
10021	Voltage 1
10022	Voltage 2
10023	Monitor status
10100	Number of read maps in default
10101	Number of read map successes
10102	Number of read map timeouts
10103	Number of read map errors
10104	Read map success streak
10105	Number of write map successes
10106	Number of write map timeouts
10107	Number of write map errors
10108	Write map success streak
10109	Number of pass-through successes
10110	Number of pass-through timeouts
10111	Number of pass-through errors
10112	Pass-through success streak
10113	Number of 43 buffer successes
10114	Number of 43 buffer timeouts
10115	Number of 43 buffer errors
10116	43 buffer success streak
11000	Read map success count
12000	Write map success count
13000	Read map timeout count
14000	Write map timeout count
15000	Read map error count
16000	Write map error count
17000	Read map success streak
18000	Write map success streak
19000	Read map is in default

## Modbus Registers for the I/O Board

The I/O board slave ID is 200.

Base Board Input Connection		Base Board Output Connection	
Modbus Register	Description	Modbus Register	Description
1	Optically isolated input 1	501	Relay 1
2	Optically isolated input 2	502	Not used
3	Universal input 1	503	Relay 2
4	Universal input 2	504	Not used
5	Universal input 3	505	NMOS Output 5
6	Universal input 4	506	NMOS Output 6
7	Universal input 5	507	NMOS Output 7
8	Universal input 6	508	NMOS Output 8
9	Universal input 7	509	DAC Output 1
10	Universal input 8	510	DAC Output 2

## Configuration Registers for the I/O Board

Register	Isolated Input A	Register	Isolated Input A
3013	Enable rising edge counter	3033	Enable rising edge counter
3014	Enable falling edge counter	3034	Enable falling edge counter
3015	High register for counter	3035	High register for counter
3016	Low register for counter	3036	Low register for counter

Universal Input Parameter Modbus Registers								
Universal Inputs	1	2	3	4	5	6	7	8
Enable Full Scale	3303	3323	3343	3363	3383	3403	3423	3443
Temperature °C/°F	3304	3324	3344	3364	3384	3404	3424	3444
Input Type	3306	3326	3346	3366	3386	3406	3426	3446
Threshold	3308	3328	3348	3368	3388	3408	3428	3448
Hysteresis	3309	3329	3349	3369	3389	3409	3429	3449
Enable Rising	4908	4928	4948	4968	4988	5008	5028	5048
Enable Falling	4909	4929	4949	4969	4989	5009	5029	5049
High Register for Counter	4910	4930	4950	4970	4990	5010	5030	5050
Low Register for Counter	4911	4931	4951	4971	4991	5011	5031	5051

**Enable Full Scale.** Set to 1 to enable a linear range from 0 to 65535 for specified input range. For a 4 to 20 mA input, a value of 0 represents 4 mA and 65535 represents 20 mA. Set this parameter to 0 to store input readings in unit-specific data. For example, the register data representing a 15.53 mA reading is 15530. For units of current (0 to 20 mA inputs), values are stored as  $\mu$ A (micro Amps) and voltage values are stored as mV (millivolts).

**Enable Rising/Falling.** Use these registers to enable the universal input logic to count on a rising transition or a falling transition. Write a one (1) to enable; write a zero (0) to disable.

**High/Low Register for Counter.** The low and high registers for the counter hold the 32-bit counter value. To erase the counter, write zeroes to both registers. To preset a counter value, write that value to the appropriate register.

Hysteresis and Threshold. Threshold and hysteresis work together to establish the ON and OFF points of an analog input. The threshold defines a trigger point or reporting threshold (ON point) for a sensor input. Setting a threshold establishes an ON point. Hysteresis defines how far below the threshold the analog input is required to be before the input is considered OFF. A typical hysteresis value is 10% to 20% of the unit's range.

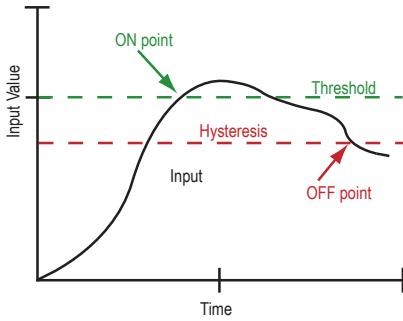

In the example shown graphically, the input is considered on at 15 mA. To consider the input off at 13 mA, set the hysteresis to 2 mA. The input will be considered off when the value is 2 mA less than the threshold.

Input Type. Program the universal inputs to accept input types NPN, PNP, 10k thermistor, 0 to 10 V, 0 to 20 mA, or potentiometer. The default setting is 8: NPN raw fast. To set the input type, write the following values to the Input Type Modbus registers.

- 0 = NPN
- 1 = PNP
- 2 = 0 to 20 mA
- 3 = 0 to 10 V dc
- 4 = 10k Thermistor
- 5 = Potentiometer Sense (DXM150 only)
- 6 = Not used
- 7 = Bridge
- 8 = NPN Raw Fast (default)

Temperature °C/°F. Set to 1 to represent temperature units in degrees Fahrenheit, and set to 0 (default) to represent temperature units in degrees Celsius.

Universal Input Register Ranges			
Register Types	Unit	Minimum Value	Maximum Value
Discrete input/output		0	1
Universal input 0 to 10 V	mV	0	10000 *
Universal input 0 to 20 mA	µA	0	20000 *
Universal input temperature (-40 °C to +85 °C)	C or F, signed, in tenths of a degree	-400	850
Universal potentiometer	unsigned	0	65535

\* Setting Enable Full Scale to 1 sets the ranges to a linear scale of 0 to 65535.

### Modbus Registers for the LCD Board (Slave ID 201)

Control the four user-defined LEDs using the display board's Modbus registers. Using write maps or ScriptBasic, write the Modbus registers shown below with 0 (off) or 1 (on). The LCD display is Modbus Slave 201

Modbus Register	I/O Connection	Modbus Register	I/O Connection
1102 : bit 0	LED 1 (top, green)	1104 : bit 0	LED 3 (amber)
1103 : bit 0	LED 2 (red)	1105 : bit 0	LED 4 (bottom, amber)

## 5.7 Restoring Factory Default Settings

To reset to factory defaults, write to two Modbus registers in the I/O board. The default slave ID for the I/O board is 200.

To reset the DXM I/O board parameters:

1. Write a 1 to Modbus register 4152

2. Write a 10 to Modbus register 4151

To reset only the I/O board:

1. Write a 0 to Modbus register 4152
2. Write a 10 to Modbus register 4151

Modbus Register	Values	Description
4151	0–255	Reset/restore trigger. This timer is based in 100 millisecond units. Once written, the timer starts to count down to zero. After the timer expires, the restore factory defaults are applied if register 4152 = 1. If register 4152 is zero, the I/O board is reset.  Default value: 0 1 = 100 milliseconds, 10 = 1 second.
4152	0–1	1 = Restores factory defaults for I/O parameters.  Default value: 0

## 5.8 Setting the Modbus Slave ID on the I/O Base Board

Only DXM150-Sx and SxR2 Modbus Slave models require that the Modbus Slave ID to be adjusted on the I/O base board. The DXM150-Bx Wireless Controller devices use DIP switch J and rotary dial K to set the Modbus slave ID. The device can use a Modbus register 6804 in the I/O board to access the full range of Modbus Slave IDs.

On the DXM150-Bx Wireless Controller models, use rotary dial K to select the lower digit of the Modbus Slave ID.

### 5.8.1 DXM150-Bx Wireless Controller Models

DIP Switch location J defines the course group of Modbus Slave IDs. DIP Switch 4 must be set to ON for DXM1xx-Sx and DXM1xx-SxR2 models.

Settings	Location J DIP Switches			
	1	2	3	4
Modbus Slave ID set to 11 through 19	OFF	OFF		
Modbus Slave ID set to 20 through 29	ON	OFF		
Modbus Slave ID set to 30 through 39	OFF	ON		
Modbus Slave ID set to 40 through 49	ON	ON		
Not Used			-	
Modbus Slave Configuration (S1 model only) <sup>2</sup>				ON
I2C Processor Communication				OFF

Rotary dial location K and DIP Switch location J set the Modbus Slave IDs.

DIP Switches J		Location K Rotary Dials — Position 0 through 9									
1	2	0	1	2	3	4	5	6	7	8	9
OFF	OFF	x <sup>3</sup>	11	12	13	14	15	16	17	18	19
ON	OFF	20	21	22	23	24	25	26	27	28	29
OFF	ON	30	31	32	33	34	35	36	37	38	39
ON	ON	40	41	42	43	44	45	46	47	48	49

#### DXM150-Bx Wireless Controller Example

To set the DXM150-Bx Wireless Controller to a Modbus Slave ID of 25, set the following:

Location J DIP switches set to: 1= ON, 2=OFF

Rotary dial set to 5

The DIP switch sets the upper digit of the slave ID to 2 while the rotary dial sets the lower digit to 5.

<sup>2</sup> Must be in the ON position for the -S1 model)

<sup>3</sup> Uses value in Modbus register 6804.



## 5.8.2 Setting the DXM I/O Board Modbus Slave ID using Modbus Registers

Write to the I/O board's Modbus register 6804 to set the Modbus Slave ID to any valid Modbus Slave ID (1 through 245).

- For the DXM150-Bx Wireless Controller model, rotary dial K should be in the zero position to use the Modbus register slave ID.

## 6 IO Base Board for the DXM150-B2 Models

### 6.1 Board Connections

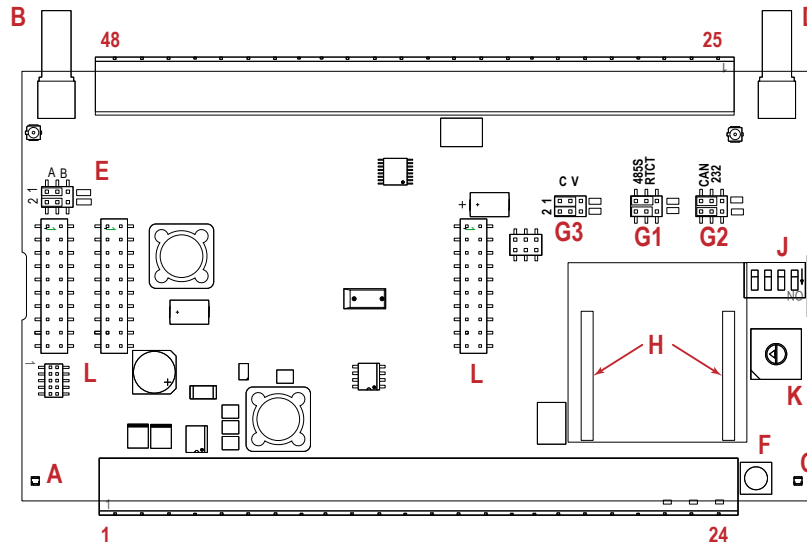

Figure 5. Board Connections

1	NC	17	Input 2B	33	Analog Output 1 (0–20 mA or 0–10 V)
2	12 to 30 V dc or solar power in (+)	18	Ground	34	Ground
3	Ground	19	Output 1 PNP/NPN	35	PWR Out - Jumper
4	Battery in (< 15 V dc) (must be a sealed lead acid battery)	20	Output 2 PNP/NPN	36	Ground
5	Ground	21	Output 3 PNP/NPN	37	Universal Input 8
6	Primary RS-485 –	22	Output 4 PNP/NPN	38	Universal Input 7
7	Primary RS-485 +	23	PWR Out OR	39	Universal Input 6
8	Ground	24	Ground	40	Universal Input 5
9	RS-232 Tx / CAN	25	Ground	41	Ground
10	RS-232 Rx / CAN	26	PWR OUT OR	42	Universal Input 4
11	Secondary RS-485 – or RS-232 RXRDY	27	Output 8 PNP/NPN	43	Universal Input 3
12	Secondary RS-485 + or RS-232 TXRDY	28	Output 7 PNP/NPN	44	Ground
13	Ground	29	Output 6 PNP/NPN	45	PWR Out - Jumper
14	Input 1A	30	Output 5 PNP/NPN	46	Universal Input 2
15	Input 1B	31	Ground	47	Universal Input 1
16	Input 2A	32	Analog Output 2 (0–20 mA or 0–10 V)	48	Ground

A	Base Board LED	E	PWR Out Jumpers	G3	Analog Output Characteristics Jumpers (Jumper 1 sets analog out 1, jumper 2 sets analog out 2)
B	Cellular Antenna	F	Radio Binding Button	H	ISM Radio Connection
C	Radio LED	G1	RS-485 Jumpers	J	Modbus Slave ID DIP Switches
D	Radio Module Antenna	G2	RS-232 Jumpers	K	Rotary Dials
				L	SAM4 Processor Board Connection

### 6.1.1 DIP Switches for the I/O Board

The DXM150-Bx Wireless Controller I/O board DIP switches are set from the factory to Modbus Slave ID 200. For more information, refer to *Setting the Modbus Slave ID on the I/O Base Board*.

### 6.1.2 I/O Board Jumpers

Hardware jumpers on the DXM I/O board allow the user to select alternative pin operations. Turn the power off to the device before changing jumper positions.

Jumper	Function	Positions
E	Analog output characteristics for A02 (pin 19) and A01 (pin 20)	<p>Defines current (0–20 mA) or voltage (0–10 V) for analog output 1 and 2.</p> <p>By default, current (0–20 mA) is selected using jumpers 1 and 2 and registers 4008 and 4028 contain a value of 2.</p> <p>To select voltage (0–10 V) for output Aout1, set jumper 1 in the voltage position (V) and set Modbus register 4008 on the I/O board (SID 200) to 3.</p> <p>To select voltage (0–10 V) for output Aout2, set jumper 2 in the voltage position (V) and set Modbus register 4028 on the I/O board (SID 200) to 3.</p>

## 6.2 Applying Power

Apply power to the DXM Wireless Controller using either 12 to 30 V dc or a 12 V dc solar panel and 12 V sealed lead acid battery.

If the incoming voltage drops below 11.2 V dc, the cellular modem does not turn on and will not turn on until the voltage is above 11.8 V dc. A text file (CmVMon.txt) on the internal micro SD card saves the periodic sampling of the incoming voltage. If cellular operation stops because of voltage, it is logged in this file.

Pin	Description
Pin 1	No connection
Pin 2	12 to 30 V dc input (+) or solar panel connection (+)
Pins 3, 5, 8, 13, 18, 24, 25, 31, 34, 36, 41, 44, 48	Main logic ground for the DXM Wireless Controller
Pin 4	Solar or backup battery positive input. Battery voltage must be less than 15 V dc. Use only a sealed lead acid (SLA) battery.
Pin 35, Pin 45	<p>These outputs are controlled by hardware jumpers.</p> <p>Jumper 2 is the power jumper for pin 45. Jumper 1 is the power jumper for pin 35. Refer to the wiring board for more information.</p> <ul style="list-style-type: none"> <li>The pin 45 jumper selects 2.7 V when in the "a" position and 12 V battery in the "b" position.</li> <li>The pin 35 jumper selects 4.2 V when in the "a" position and device power on pin 2 in the "b" position.</li> </ul>
Pin 23, Pin 26	Courtesy power output from either the input power from pin 2 or the battery power from pin 4.

### 6.2.1 Using the Auxiliary Power Outputs

The DXM150-Bx Wireless Controller has two auxiliary power outputs, pin 35 and pin 45. They are controlled by hardware jumpers on the I/O base board. Refer to the wiring board diagram for more information.

Jumper 2 is the power jumper for pin 45. Jumper 1 is the power jumper for pin 35.

- The pin 45 jumper selects 2.7 V when in the "a" position and 12 V battery in the "b" position.
- The pin 35 jumper selects 4.2 V when in the "a" position and device power on pin 2 in the "b" position.

### 6.2.2 Connecting a Battery to the DXM Wireless Controller

When attaching a battery to the DXM Wireless Controller as a backup battery or as a solar battery, verify the charging algorithm is set properly. The factory default setting for the battery charging algorithm assumes you are using 12 to 30 V dc to recharge the battery.

The charging algorithm is designed to work with a sealed lead acid (SLA) battery only.

- When using 12 to 30 V dc, connect the 12 to 30 V dc + to pin 2 and connect the ground to pin 3.
- When using main dc power with a back up battery (default configuration), connect the incoming main power pin 2 (+) and to pin 3 (-). Connect the 12 V sealed lead acid battery to pin 4 (+) and pin 5 (-). The incoming main power must be 15 to 30 V dc to charge the battery.

- When using a solar panel, connect the solar panel output to pin 2 and connect the ground to pin 3. Connect the 12 V dc SLA battery to pin 4 (+) and pin 5 (-). To change the charging algorithm, refer to [Supplying Power from a Solar Panel](#) on page 20.

Modbus Slave ID	Modbus Register	Description
200 *	6071	Battery backup charging algorithm. 0 = Battery is recharged from a solar panel 1 = Battery is recharged from 12 to 30 V dc (default)

\* The Modbus Slave ID for the base board is set at the factory and may be changed using the base board DIP switch settings.

### 6.2.3 Supplying Power from a Solar Panel

To power the DXM150-Bx Wireless Controller from a 12 V dc solar panel, connect the solar panel to power pins 2(+) and 3(-). Connect a 12 V dc sealed lead acid (SLA) rechargeable battery to pins 4(+) and 5(-).

The factory default setting for the battery charging algorithm assumes you are using 12 to 30 V dc power to recharge the battery. If the incoming power is from a solar panel, you must change the charging algorithm.

To change the charging algorithm from the menu system:

- From the LCD menu, select Update > Power.
- Use the up/down arrows to select "SOLAR" power.

To change the charging algorithm by writing to Modbus register 6071 on the I/O base board (Slave ID 200):

- Write a 0 to select the solar power charging algorithm.

Modbus Slave ID	Modbus Register	Description
200 *	6071	Battery backup charging algorithm. 0 = Battery is recharged from a solar panel 1 = Battery is recharged from 12 to 30 V dc (default)

The following power operating characteristics are stored in Modbus registers.

#### Battery voltage

If no battery is present, the value in this register is less than 5 V. If the value in this register is greater than the incoming voltage register, the battery is powering the system.

#### Battery charging current

The charging algorithm charges the battery when the incoming voltage register value is greater than the battery voltage register value. This registers shows the charging current in milliamps.

#### Incoming supply voltage

The incoming power can be from a solar panel or from a power supply. The battery is charging when the incoming voltage register value is greater than the battery voltage register value. The battery is powering the system when the incoming voltage register value is less than the battery voltage register value.

#### On-board thermistor temperature

This register stores the on-board thermistor reading in tenths of degrees C, this is not a calibrated input: divide by 10 to calculate the temperature in degrees C. For calibrated temperature inputs, define one of the universal inputs as a temperature input.

Modbus Slave ID	Modbus Register	Description
200 *	6081	Battery voltage (mV)
	6082	Battery charging current (mA)
	6083	Incoming supply voltage (mV) (solar or power supply)
	6084	On-board thermistor temperature (°C)

\* The Slave ID for the base board is set at the factory. This may be changed using the base board DIP switch settings.

## 6.3 Working with Solar Power

A reliable solar system requires careful planning and monitoring to size the components correctly. The recommendations provided are for the DXM Wireless Controller system as an autonomous system.

Adding extra components increases the power requirements and likely requires increasing the solar system components. Depending upon the geographical location, the size of the solar panel and battery may vary.

### 6.3.1 Setting the DXM Wireless Controller for Solar Power

By default, the DXM Wireless Controller is set from the factory to charge a backup battery from a line power source. Use the LCD menu on the front of the DXM Wireless Controller to change the charging algorithm to solar power.

Go to System > Power Select. Change the Power to Solar.

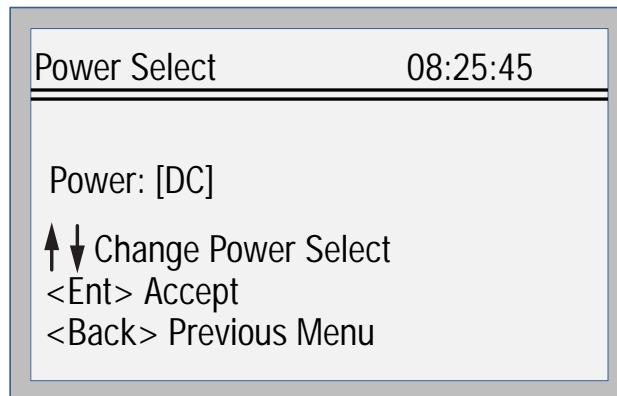

For DXM devices without an LCD, adjust the I/O board Modbus register 6071. Set the register to 0 to select battery charging from a solar panel, and set to 1 to select battery charging from incoming 12 to 30 V dc supply.

Here are a few DXM configuration tips to help minimize the power consumption (may not apply to all models).

- If Ethernet is not being used, save up to 25% of the consumed power by disabling Ethernet. Set DIP switch 1 to the ON position on the processor board then reboot.
- Instead of powering external devices all the time, take advantage of the switched power mechanisms to turn off devices when possible.
- Minimize the number of cellular transactions and the amount of data pushed across the cellular modem.

### 6.3.2 Solar Components

The components of a solar system include the battery and the solar panel.

#### Battery

The DXM solar controller is designed to use a 12 V lead acid battery. The characteristics of a solar system require the battery to be of a certain type. There are basically two types of lead acid batteries:

- SLI batteries (Starting Lights Ignition) designed for quick bursts of energy, like starting engines
- Deep Cycle batteries - greater long-term energy delivery. This is the best choice for a solar battery.

Since a solar system charges and discharges daily, a deep cycle battery is the best choice. There are different versions of a lead acid battery: wet cell (flooded), gel cell, and an AGM (absorbed glass mat).

Wet cell batteries are the original type of rechargeable battery and come in two styles, serviceable and maintenance free. Wet cell batteries typically require special attention to ventilation as well as periodic maintenance but are the lowest cost. The gel cell and AGM battery are sealed batteries that cost more but store very well and do not tend to sulfate or degrade as easily as a wet cell. Gel or AGM batteries are the safest lead acid batteries you can use.

#### Battery Capacity

Battery capacity is a function of the ambient temperature and the rate of discharge. Depending upon the specific battery, a battery operating at -30 °C can have as much as 40 percent less capacity than a battery operating at 20 °C. Choose enough battery capacity based on your geographical location.

A larger capacity battery typically lasts longer for a given solar application because lead-acid batteries do not like deep cycling (discharging a large percentage of its capacity). Depending upon the battery, a battery discharging only 30 percent of its capacity before recharging will have approximately 1100 charge/discharge cycles. The same battery discharging 50 percent of its capacity will have approximately 500 charge/discharge cycles. Discharging 100 percent leaves the battery with only 200 charge/discharge cycles.

Batteries degrade over time based on discharge/charge cycles and environmental conditions. Always monitor the battery system to obtain the best performance of the solar powered system.

Use this as a guide to the approximate state of charge and in determining when to apply conservation measures.

Average Voltage Readings Relative to Battery Change	
State of Charge (%)	Open Circuit Voltage
100	13.0 or higher
75	12.6
50	12.1
25	11.66
0	11.4 or less

### Solar Panel

Banner solar panels come in two common sizes for the DXM Wireless Controller: 5 Watt and 20 Watt. Both panels are designed to work with the DXM Wireless Controller but provide different charging characteristics. Use the 5 watt panel for light duty operation and use the 20 watt panel when you require greater charging capabilities.

Solar Panel	Voltage	Current	Typical DXM Configurations
5 Watt	17 V	0.29 A	DXM slave controller, ISM radio, I/O base board
20 Watt	21 V	1 A	DXM Controller with ISM radio and Cellular modem

Photovoltaic panels are very sensitive to shading. Unlike solar thermal panels, PV solar panels cannot tolerate shading from a branch of a leafless tree or small amounts of snow in the corners of the panel. Because all cells are connected in a series string, the weakest cell will bring down the other cells' power level.

Good quality solar panels will not degrade much from year to year, typically less than 1 percent .

#### Solar Panel Mounting

To capture the maximum amount of solar radiation throughout the year, mount a fixed solar panel to optimize the sun's energy throughout the year. For the northern hemisphere, face the panel true south. For the southern hemisphere, face the panel true north. If you are using a compass to orientate the panels, compensate for the difference between true north and magnetic north. Magnetic declination varies across the globe.

A solar panel's average tilt from horizontal is at an angle equal to the latitude of the site location. For optimum performance, adjust the tilt by plus 15 degrees in the winter or minus 15 degrees in the summer. For a fixed panel with a consistent power requirement throughout the year, adjust the tilt angle to optimize for the winter months: latitude plus 15 degrees. Although in the summer months the angle may not be the most efficient, there are more hours of solar energy available.

For sites with snow in the winter months, the increased angle helps to shed snow. A solar panel covered in snow produces little or no power.

### 6.3.3 Recommended Solar Configurations

These solar panel and battery combinations assume direct sunlight for two to three hours a day. Solar insolation maps provide approximate sun energy for various locations. The depth of battery discharge is assumed to be 50 percent.

Solar panel and battery combinations for a DXM Wireless Controller system				
Solar Panel	Battery Capacity <sup>4</sup>	Days of Autonomy	DXM mA	DXM Controller
5 watt	10 Ahr	10 days	25 mA	DXM Slave Controller - ISM radio and I/O base board
20 watt	14 Ahr	10 days	30 mA	DXM Controller with ISM radio
20 watt	20 Ahr	10 days	35 mA	DXM Controller with ISM radio and Cellular Modem

<sup>4</sup> Battery capacity (amp hour) is standard amp rating taken for 20 hours. Battery capacity should be monitored for reliable system power and may need to be increased for cold weather locations.

### 6.3.4 Monitoring Solar Operation

The DXM solar controller provides Modbus registers that allow the user to monitor the state of the solar panel input voltage, the battery voltage, the charging current, and the temperature in °C. The DXM Wireless Controller can be configured to monitor the health of the charging system as well as send an alert message when the battery is too low.

The charts show a typical charging cycle, with each vertical grid representing about eight hours. The chart shows three days of charging.

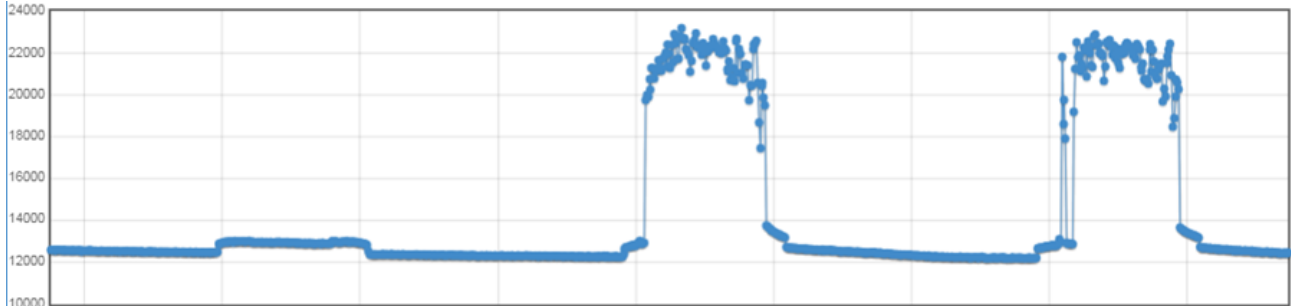

Figure 6. Solar Panel Voltage (mV) -- Cloudy First Day

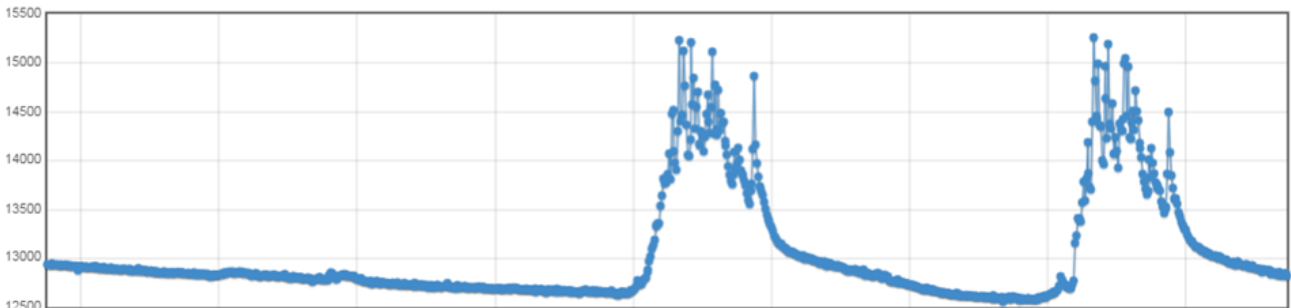

Figure 7. Battery Voltage (mV) - Cloudy First Day

## 6.4 Connecting the Communication Pins

The base board communications connections to the device are RS-485 (primary), RS-485 (secondary) or RS-232.

**RS-485**—The primary RS-485 bus is a common bus shared with the radio board (Modbus Slave ID 1). The DXM150-Bx Wireless Controller is defined as the Modbus Master on this bus. Other internal Modbus slaves include the local processor registers (Modbus Slave ID 199), the base I/O controller (Modbus Slave ID 200), and the display board (Modbus Slave ID 201). When assigning Modbus Slave IDs to externally connected devices, only use IDs 2 through 198.

**RS-232**—The RS-232 bus is not currently defined.

Pin	Parameter	Description
Pin 6	Primary RS-485 –	Running Modbus protocol at 19.2k baud, use this bus to connect to other Modbus Slave devices. The DXM150-Bx Wireless Controller is a Modbus Master device on this RS-485 port.
Pin 7	Primary RS-485 +	
Pin 9	RS-232 Tx	Serial RS-232 connection. This bus must use a ground connection between devices to operate correctly.
Pin 10	RS-232 Rx	
Pin 11	Secondary RS-485 – or RS-232 RXDY	Dual purpose I/O communications pins; select using the RS-485 and RS-232 Selection Jumpers (see <a href="#">Figure 1</a> on page 18). <ul style="list-style-type: none"> <li>In position "a" these pins are a secondary RS-485 bus. The DXM150-Bx Wireless Controller is a Modbus slave on this bus.</li> <li>In position "b" these pins are the flow control signals for the RS-232 signal on pins 9 and 10.</li> </ul>
Pin 12	Secondary RS-485 + or RS-232 TXRDY	

### 6.4.1 Modbus RTU Master/Modbus RTU Slave

The DXM150-Bx Wireless Controller can be a Modbus RTU master device to other slave devices and can be a Modbus slave device to another Modbus RTU master.

The DXM150-Bx Wireless Controller uses the primary RS-485 port as a Modbus RTU master to control external slave devices. The secondary port is the Modbus RTU slave connection.

- As a Modbus RTU master device, the DXM150-Bx Wireless Controller controls external slaves connected to the primary RS-485 port, the local ISM radio, local I/O base board, and the local display board.
- As a Modbus RTU slave device, the DXM150-Bx Wireless Controller local registers can be read from or written to by another Modbus RTU master device.

Use the DXM Configuration Tool to define operational settings for both the Modbus RTU master port and the Modbus RTU slave port.

## 6.5 Modbus Master Port and Slave Port

There are two RS-485 ports on the DXM Wireless Controller, a Modbus master RS-485 port and a Modbus slave RS-485 port.

The Modbus master RS-485 is controlled by the DXM Wireless Controller, which acts as the Modbus master. All wired devices connected to the master RS-485 port must be slave devices.

The Modbus slave RS-485 port is controlled by another Modbus master device, not the DXM Wireless Controller. The slave port is used by other devices that want to access the DXM Wireless Controller as a Modbus slave device. All local registers are available to be read or written from this slave port. Set the Modbus Slave ID for the secondary RS-485 port using the LCD display menu: System > DXM Slave ID.

### 6.5.1 Modbus Master and Slave Port Settings

The basic communications parameters for the RS-485 ports are set in the DXM Configuration Tool and are saved in the XML configuration file. All basic settings are available under Settings > General screen of the DXM Configuration Tool.

Master port parameters include:

- Baud rate and parity
- Set the Communications Timeout parameter to cover the expected time for messages to be sent throughout the wireless network. For the DXM Wireless Controller, the Communications Timeout parameter is the maximum amount of time the DXM Wireless Controller should wait after a request is sent until the response message is received from the Modbus slave device.
- Maximum Polling Rate sets the minimum wait time from the end of a Modbus transaction to the beginning of the next Modbus transaction.

The screenshot shows the 'Settings' screen in the DXM Configuration Tool, with the 'General' tab selected. The interface includes a sidebar on the left with options like 'Local Registers', 'Register Mapping', 'Action Rules', 'Scheduler', 'Register View', and 'Settings'. The main content area is divided into several sections:

- Device Time:** Includes 'Current device time' (displayed as --:--:--), 'Get Time From Device' and 'Synch PC Time with Device' buttons, 'Device timezone (UTC)' set to 'Central Standard Time (UTC-06:00) Central Time (L)', and a 'Device observes DST' checkbox.
- Device Location/GPS:** Includes 'Default latitude' and 'Default longitude' (both set to 0), 'Acquire using' set to 'Default Lat/Lon', 'External GPS address' (set to 0), 'Acquire GPS data every (hh:mm:ss)' (set to 00:00:00), and a 'Send location to cloud' checkbox.
- Modbus Master Communications:** Includes 'Serial mode' (RS-485), 'Baud rate' (19200), 'Parity' (None), 'Communication timeout (hh:mm:ss.fff)' (00:00:05.000), 'Maximum polling rate (hh:mm:ss.fff)' (00:00:00.050), and an 'Enable DX80 polling (43 buffer)' checkbox.
- Modbus Slave Communications:** Includes 'Serial mode' (RS-485), 'Baud rate' (19200), 'Parity' (None), and a 'Wireless Modbus backbone' checkbox.

The Modbus Slave port settings include:

- Baud rate and parity (also set on this screen)
- Set the Modbus Slave port ID using the DXM Wireless Controller LCD
- Set the Wireless Modbus Backbone parameter when there is an ISM radio plugged into the SAM4 processor board and the Modbus slave port is using the MultiHop radio as the slave port instead of the terminal block connection.



## 6.5.2 Modbus Slave Port ID

Set the DXM Modbus slave port using the LCD menu system. On the LCD, use the down arrow to highlight System. Enter the System menu by clicking Enter.

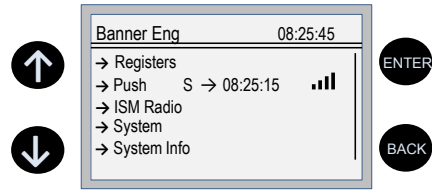

To change the DXM Slave ID, highlight DXM Slave ID, then click Enter.

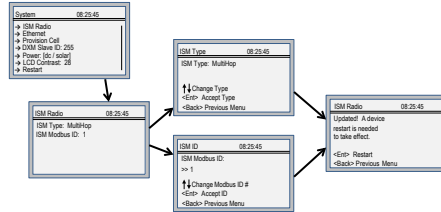

Use the up and down arrow buttons to change the DXM Slave ID.

Press Enter to accept the ID change.

After you change the DXM Slave ID, use the DXM Configuration Tool to cycle power to the device. After cycling power to the device, the updated DXM Slave ID is listed under the System menu.

## 6.6 Inputs and Outputs

The I/O base board is a Modbus slave device (Slave ID 200) that communicates to the processor board using Modbus commands. Use the DXM Configuration Tool to create a configuration using read/write maps that will access inputs or outputs on the I/O board.

Communication with the I/O board runs at a maximum rate of 10 ms per transaction. The parameter setting for the bus with the I/O board and the processor board are fixed. External Modbus communication runs at a maximum rate of 50 ms per transaction. The parameter settings for the external RS-485 buses are controlled by the DXM Configuration Tool.

Refer to the Modbus Registers section for more descriptions of each Modbus register on the DXM150-Bx Wireless Controller.

### 6.6.1 Universal Inputs

The universal inputs can be programmed to accept different types of inputs: discrete NPN/PNP, 0 to 20 mA analog, 0 to 10 V analog, 10k thermistor, potentiometer sense, bridge, and NPN raw fast. Use the DXM Configuration Tool tool to write to the appropriate Modbus registers in the I/O board to configure the input type.

The universal inputs are treated as analog inputs. When the universal inputs are defined as mA, V, or temperature, use Modbus registers to configure the operational characteristics of the inputs. These parameters are temperature conversion type, enable full scale, threshold and hysteresis. See the Modbus register section for the parameter definitions.

When a universal input is configured as an NPN or PNP input type, it can be enabled to be a synchronous counter. Enable the counter function by setting Modbus register 'Enable Rising' or 'Enable Falling' to 1. See *Modbus Registers* for the universal input register definitions.

Pin	Univ. Input	Description
Pin 47	Universal Input 1	Program the universal inputs to accept input types NPN, PNP, 10k thermistor, 0 to 10 V, 0 to 20 mA, or potentiometer. The default setting is 8: NPN raw fast. To set the input type, write the following values to the Input Type Modbus registers. 0 = NPN 1 = PNP 2 = 0 to 20 mA 3 = 0 to 10 V dc 4 = 10k Thermistor 5 = Potentiometer Sense (DXM150 only) 6 = Not used 7 = Bridge 8 = NPN Raw Fast (default)
Pin 46	Universal Input 2	
Pin 43	Universal Input 3	
Pin 42	Universal Input 4	
Pin 40	Universal Input 5	
Pin 39	Universal Input 6	
Pin 38	Universal Input 7	

Pin	Univ. Input	Description
Pin 37	Universal Input 8	

**Thermistor Input.** A thermistor input must use a 10k thermistor between ground and the universal input. The thermistor must be a 10k NTC (Banner model number BWA-THERMISTOR-002) or equivalent. Select the temperature conversion of degrees C (default) or degrees F by writing to the Modbus registers defined in *I/O Base Board*.

**Potentiometer Sense (DXM150 only).** A potentiometer input is created from two inputs: a voltage source (pin 45) that supplies a voltage to the potentiometer and an input sense (Potentiometer Sense) to read the resistance. Follow [Example: Change Universal Input 8 to Read a Potentiometer Input](#) on page 27 to configure the DXM150 Controller for a potentiometer input.

**Potentiometer Input (DXM100 only).** A potentiometer input is created from three inputs: a voltage source (pin 30) that supplies 5 V to the potentiometer and two inputs set to voltage inputs to read the voltage across the potentiometer. See the DXM technical note for setting up a potentiometer.

**Bridge Input.** The bridge input is not implemented yet.

**NPN vs NPN Raw Fast.** The difference between NPN and NPN Raw Fast is the amount of settling time given to the input. Switch the input type to NPN if the input is not detecting a transition.

### Example: Configure Input 1 as a Synchronous Counter

1. Connect the DXM Wireless Controller to the PC.
2. Launch the DXM Configuration Tool software.
3. Connect to the DXM Wireless Controller by selecting the Device > Connection Settings menu option. You may connect using either USB or Ethernet.
4. Select a COMM port from the drop-down list and click Connect.
5. Click on the Register View tab on the left part of the page.
6. Change the Source Register selection to I/O Board Registers.
7. In the Write Registers area, write Modbus register 4908 to 1 to enable counting on the rising edge of the input signal.
8. Read Modbus registers 4910 and 4911 to get the 32-bit value of the count.

### Example: Change Universal Input 2 to a 0 to 10 V dc Input

1. Connect the DXM Wireless Controller to the PC.
2. Launch the DXM Configuration Tool software.
3. Connect to the DXM Wireless Controller by selecting the Device > Connection Settings menu option. You may connect using either USB or Ethernet.
4. Select a COMM port from the drop-down list and click Connect.
5. Click on the Register View tab on the left part of the page.
6. Change the Source Register selection to I/O Board Registers.
7. Write a 3 to Modbus register 3326 on Modbus Slave ID 200 (I/O board).
8. Cycle power to the device.
9. Using the Register View tab, read register 3326 to verify it is set to 3.

### Example: Change Analog Output 1 to a 0 to 10 V dc Output

1. Connect the DXM Wireless Controller to the PC.
2. Launch the DXM Configuration Tool software.
3. Connect to the DXM Wireless Controller by selecting the Device > Connection Settings menu option. You may connect using either USB or Ethernet.
4. Select a COMM port from the drop-down list and click Connect.
5. Click on the Register View tab on the left part of the page.
6. Change the Source Register selection to I/O Board Registers.
7. Set jumper 1 on the I/O base board to the 0 to 10 V position. Refer to the base board image for the analog output jumper position.
8. Write a 3 to Modbus register 4008 on Modbus Slave ID 200 (I/O board).
9. Cycle power to the device.
10. Using the Register View tab, read register 4008 to verify it is set to 3.

### Example: Change Universal Input 8 to Read a Potentiometer Input

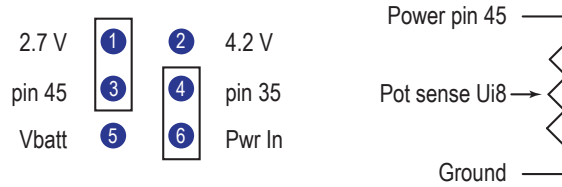

Figure 8. Default jumper position

1. Launch the DXM Configuration Tool tool.
2. Click on the Register View tab on the left part of the page.
3. In the upper right part of the window select Modbus Registers using Modbus Slave ID radio button and enter Modbus Slave ID 200.
4. To set universal input 8 as the sense, write Modbus register 3446 with 5 (Potentiometer Sense).
5. Verify the jumpers are still set to their default position. One jumper should be on pins 1 and 3 to get a 2.7 V source voltage out pin 45. The default position of the other jumper is on pins 4 and 6.
6. Connect one potentiometer side to power output (pin 45), connect the tap point of the pot to universal input 8 (pin 37), and connect the other end of the pot to ground (pin 36).

### 6.6.2 PNP and NPN Outputs

Pin	Output	Modbus Register	Description	PNP OUT Wiring	NPN OUT Wiring
19	1	501	PNP/NPN Output 1		
20	2	502	PNP/NPN Output 2		
21	3	503	PNP/NPN Output 3		
22	4	504	PNP/NPN Output 4		
30	5	505	PNP/NPN Output 5		
29	6	506	PNP/NPN Output 6		
28	7	507	PNP/NPN Output 7		
27	8	508	PNP/NPN Output 8		

### 6.6.3 Analog Outputs (DAC)

The following characteristics are configurable for each of the analog outputs.

Pin	Output	Description
Pin 33	Analog Output 1	0 to 20 mA or 0 to 10 V dc output (I/O board jumper selectable) Accuracy: 0.1% of full scale +0.01% per °C Resolution: 12-bit
Pin 32	Analog Output 2	

Parameters for Analog Output 1 start at 4001 through 4008. Parameters for Analog Output 2 start at 4021 through 4028.

Parameter Registers for Analog Outputs (4xxxx)		
OUT 1	OUT 2	Parameters
4001	4021	Maximum Analog Value
4002	4022	Minimum Analog Value
4003	4023	Enable Register Full Scale
4004	4024	Hold Last State Enable
4005	4025	Default Output State
4008	4028	Analog Output Type

**Analog Output Type.** The analog outputs may be configured as either 0 to 20 mA outputs (default) or 0 to 10 V outputs. To change the analog output type change the hardware jumper position and write to the Modbus register that defines the analog output type. For analog output 1, write to Modbus register 4008, for analog output 2 write to Modbus register 4028. Write a value of 2 (default) to select 0 to 20 mA; write a value of 3 to select 0 to 10 V.

**Default Output Conditions.** Default output conditions/triggers are the conditions that drive outputs to defined states. Example default output conditions include when radios are out of sync, when a device cycles power, or during a host communication timeout.

- 2952 Enable Default Communication Timeout. A "communication timeout" refers to the communication between any Modbus master host and the DXM baseboard. Set this register to 1 to enable the default condition when the host has not communicated with the DXM baseboard for the period of time defined by the Communication Default IO Timeout.
- 2953 Communication Default I/O Timeout (100 ms/Count). This parameter defines the host timeout period in 100 millisecond increments. If a host does not communicate within this timeout period, the device outputs are set to the default values.
- 2954 Enable Default on Power Up. Setting this parameter to 1 sends the device outputs to their default condition when the DXM baseboard is powered up. Set to 0 to disable this feature.

**Default Output State.** The Default Output State parameter represents the default condition of the analog output. When an error condition exists, the outputs are set to this 16-bit user-defined output state. To define the error conditions for device outputs, refer to the MultiHop default output parameters 2950-2954.

**Enable Register Full Scale.** Set to 1 to enable a linear range from 0 to 65535 for specified input range. For a 4 to 20 mA output, a value of 0 represents 4 mA and 65535 represents 20 mA. Set this parameter to 0 to store readings in unit-specific data. For example, the register data representing a 15.53 mA reading is 15530. For units of current (0 to 20 mA outputs), values are stored as  $\mu$ A (micro Amps) and voltage values are stored as mV (millivolts).

**Hold Last State Enable.** Set the Hold Last State to 1 to set the output to its last known value before the error occurred. Set this parameter to 0 to disable the Hold Last State and use the Default Output State setting during an error condition.

**Maximum Analog Value.** The Maximum Analog Value register stores the maximum allowed analog value. The specific units of measure apply to the register value. For example, the register may contain 20000, for 20 mA, or for a voltage output the register may contain 8000, for 8 volts.

**Minimum Analog Value.** The Minimum Analog Value register stores the minimum allowed analog value. The specific units of measure apply to register value. For example, the register may contain 4000, for 4 mA, or for a voltage output the register may contain 2000, for 2 volts.

## 6.6.4 Modbus Registers

The DXM150-Bx Wireless Controller may have up to three internal Modbus slave devices:

- Slave ID 1: PE/HE ISM radio socket
- Slave ID 199: Internal Local Registers
- Slave ID 200: I/O base
- Slave ID 201: LCD display board

All Modbus registers are defined as 16-bit Modbus Holding Registers. When connecting external Modbus slave devices, only use Modbus slave IDs 2 through 198. The I/O base and LCD display slave IDs are fixed, but the internal radio slave ID can be changed if needed.

### Internal Local Registers (Slave ID 199)

Registers	Definition
1-450	Local Registers - Internal processor memory
451-500	Local Registers - Data Flash (Non-volatile)
1001-1500	Local Registers - Floating point registers, internal processor memory
10001	GPS latitude direction (N,S,E,W)
10002	GPS latitude
10003	GPS longitude direction (N,S,E,W)
10004	GPS longitude
10011-11012	Resync timer (high, low) (syncing radios)
10013-10014	Resync timer rollover (high, low) (syncing radios)
10015-11016	Reboot Message (high, low) (See restart codes)
10017-11018	Watchdog reset count (high, low)

Registers	Definition
10021	Voltage 1
10022	Voltage 2
10023	Monitor status
10100	Number of read maps in default
10101	Number of read map successes
10102	Number of read map timeouts
10103	Number of read map errors
10104	Read map success streak
10105	Number of write map successes
10106	Number of write map timeouts
10107	Number of write map errors
10108	Write map success streak
10109	Number of pass-through successes
10110	Number of pass-through timeouts
10111	Number of pass-through errors
10112	Pass-through success streak
10113	Number of 43 buffer successes
10114	Number of 43 buffer timeouts
10115	Number of 43 buffer errors
10116	43 buffer success streak
11000	Read map success count
12000	Write map success count
13000	Read map timeout count
14000	Write map timeout count
15000	Read map error count
16000	Write map error count
17000	Read map success streak
18000	Write map success streak
19000	Read map is in default

## Modbus Registers for the I/O Board

The I/O board is Slave ID 200.

Base Board Input Connection		Base Board Output Connection	
Modbus Register	Description	Modbus Register	Description
1	Optically isolated input 1	501	PNP/NPN Output 1
2	Optically isolated input 2	502	PNP/NPN Output 2
3	Universal input 1	503	PNP/NPN Output 3
4	Universal input 2	504	PNP/NPN Output 4
5	Universal input 3	505	PNP/NPN Output 5
6	Universal input 4	506	PNP/NPN Output 6
7	Universal input 5	507	PNP/NPN Output 7
8	Universal input 6	508	PNP/NPN Output 8
9	Universal input 7	509	DAC Output 1
10	Universal input 8	510	DAC Output 2

## Configuration Registers for the I/O Board

Register	Isolated Input A	Register	Isolated Input A
3013	Enable rising edge counter	3033	Enable rising edge counter
3014	Enable falling edge counter	3034	Enable falling edge counter
3015	High register for counter	3035	High register for counter
3016	Low register for counter	3036	Low register for counter

Universal Input Parameter Modbus Registers								
Universal Inputs	1	2	3	4	5	6	7	8
Enable Full Scale	3303	3323	3343	3363	3383	3403	3423	3443
Temperature °C/°F	3304	3324	3344	3364	3384	3404	3424	3444
Input Type	3306	3326	3346	3366	3386	3406	3426	3446
Threshold	3308	3328	3348	3368	3388	3408	3428	3448
Hysteresis	3309	3329	3349	3369	3389	3409	3429	3449
Enable Rising	4908	4928	4948	4968	4988	5008	5028	5048
Enable Falling	4909	4929	4949	4969	4989	5009	5029	5049
High Register for Counter	4910	4930	4950	4970	4990	5010	5030	5050
Low Register for Counter	4911	4931	4951	4971	4991	5011	5031	5051

**Enable Full Scale.** Set to 1 to enable a linear range from 0 to 65535 for specified input range. For a 4 to 20 mA input, a value of 0 represents 4 mA and 65535 represents 20 mA. Set this parameter to 0 to store input readings in unit-specific data. For example, the register data representing a 15.53 mA reading is 15530. For units of current (0 to 20 mA inputs), values are stored as  $\mu$ A (micro Amps) and voltage values are stored as mV (millivolts).

**Enable Rising/Falling.** Use these registers to enable the universal input logic to count on a rising transition or a falling transition. Write a one (1) to enable; write a zero (0) to disable.

**High/Low Register for Counter.** The low and high registers for the counter hold the 32-bit counter value. To erase the counter, write zeroes to both registers. To preset a counter value, write that value to the appropriate register.

Hysteresis and Threshold. Threshold and hysteresis work together to establish the ON and OFF points of an analog input. The threshold defines a trigger point or reporting threshold (ON point) for a sensor input. Setting a threshold establishes an ON point. Hysteresis defines how far below the threshold the analog input is required to be before the input is considered OFF. A typical hysteresis value is 10% to 20% of the unit's range.

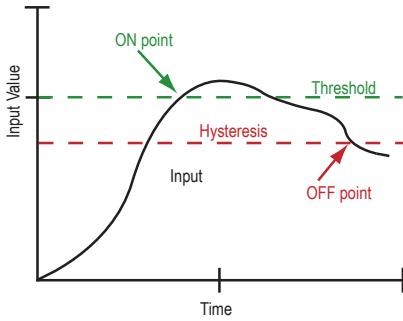

In the example shown graphically, the input is considered on at 15 mA. To consider the input off at 13 mA, set the hysteresis to 2 mA. The input will be considered off when the value is 2 mA less than the threshold.

Input Type. Program the universal inputs to accept input types NPN, PNP, 10k thermistor, 0 to 10 V, 0 to 20 mA, or potentiometer. The default setting is 8: NPN raw fast. To set the input type, write the following values to the Input Type Modbus registers.

- 0 = NPN
- 1 = PNP
- 2 = 0 to 20 mA
- 3 = 0 to 10 V dc
- 4 = 10k Thermistor
- 5 = Potentiometer Sense (DXM150 only)
- 6 = Not used
- 7 = Bridge
- 8 = NPN Raw Fast (default)

Temperature °C/°F. Set to 1 to represent temperature units in degrees Fahrenheit, and set to 0 (default) to represent temperature units in degrees Celsius.

Universal Input Register Ranges			
Register Types	Unit	Minimum Value	Maximum Value
Discrete input/output		0	1
Universal input 0 to 10 V	mV	0	10000 *
Universal input 0 to 20 mA	µA	0	20000 *
Universal input temperature (-40 °C to +85 °C)	C or F, signed, in tenths of a degree	-400	850
Universal potentiometer	unsigned	0	65535

\* Setting Enable Full Scale to 1 sets the ranges to a linear scale of 0 to 65535.

### Modbus Registers for the LCD Board (Slave ID 201)

Control the four user-defined LEDs using the display board's Modbus registers. Using write maps or ScriptBasic, write the Modbus registers shown below with 0 (off) or 1 (on). The LCD display is Modbus Slave 201

Modbus Register	I/O Connection	Modbus Register	I/O Connection
1102 : bit 0	LED 1 (top, green)	1104 : bit 0	LED 3 (amber)
1103 : bit 0	LED 2 (red)	1105 : bit 0	LED 4 (bottom, amber)

## 6.7 Restoring Factory Default Settings

To reset to factory defaults, write to two Modbus registers in the I/O board. The default slave ID for the I/O board is 200.

To reset the DXM I/O board parameters:

1. Write a 1 to Modbus register 4152

2. Write a 10 to Modbus register 4151

To reset only the I/O board:

1. Write a 0 to Modbus register 4152
2. Write a 10 to Modbus register 4151

Modbus Register	Values	Description
4151	0–255	Reset/restore trigger. This timer is based in 100 millisecond units. Once written, the timer starts to count down to zero. After the timer expires, the restore factory defaults are applied if register 4152 = 1. If register 4152 is zero, the I/O board is reset.  Default value: 0 1 = 100 milliseconds, 10 = 1 second.
4152	0–1	1 = Restores factory defaults for I/O parameters.  Default value: 0

## 6.8 Setting the Modbus Slave ID on the I/O Base Board

Only DXM150-Sx and SxR2 Modbus Slave models require that the Modbus Slave ID to be adjusted on the I/O base board. The DXM150-Bx Wireless Controller devices use DIP switch J and rotary dial K to set the Modbus slave ID. The device can use a Modbus register 6804 in the I/O board to access the full range of Modbus Slave IDs.

On the DXM150-Bx Wireless Controller models, use rotary dial K to select the lower digit of the Modbus Slave ID.

### 6.8.1 DXM150-Bx Wireless Controller Models

DIP Switch location J defines the course group of Modbus Slave IDs. DIP Switch 4 must be set to ON for DXM1xx-Sx and DXM1xx-SxR2 models.

Settings	Location J DIP Switches			
	1	2	3	4
Modbus Slave ID set to 11 through 19	OFF	OFF		
Modbus Slave ID set to 20 through 29	ON	OFF		
Modbus Slave ID set to 30 through 39	OFF	ON		
Modbus Slave ID set to 40 through 49	ON	ON		
Not Used			-	
Modbus Slave Configuration (S1 model only) <sup>5</sup>				ON
I2C Processor Communication				OFF

Rotary dial location K and DIP Switch location J set the Modbus Slave IDs.

DIP Switches J		Location K Rotary Dials — Position 0 through 9									
1	2	0	1	2	3	4	5	6	7	8	9
OFF	OFF	x <sup>6</sup>	11	12	13	14	15	16	17	18	19
ON	OFF	20	21	22	23	24	25	26	27	28	29
OFF	ON	30	31	32	33	34	35	36	37	38	39
ON	ON	40	41	42	43	44	45	46	47	48	49

#### DXM150-Bx Wireless Controller Example

To set the DXM150-Bx Wireless Controller to a Modbus Slave ID of 25, set the following:

Location J DIP switches set to: 1= ON, 2=OFF

Rotary dial set to 5

The DIP switch sets the upper digit of the slave ID to 2 while the rotary dial sets the lower digit to 5.

<sup>5</sup> Must be in the ON position for the -S1 model)  
<sup>6</sup> Uses value in Modbus register 6804.



## 6.8.2 Setting the DXM I/O Board Modbus Slave ID using Modbus Registers

Write to the I/O board's Modbus register 6804 to set the Modbus Slave ID to any valid Modbus Slave ID (1 through 245).

- For the DXM150-Bx Wireless Controller model, rotary dial K should be in the zero position to use the Modbus register slave ID.

## 7 Cellular CDMA

### 7.1 Cellular Modem Board

---

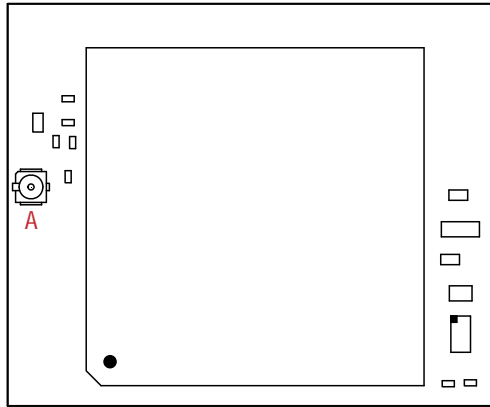

The optional cellular modem is installed on the SAM4 processor board on the two 12-pin sockets. The U.FL connector should be to the left, with the antenna cable going to the left antenna U.FL connector.

### 7.2 Cellular Power Requirements

---

If the incoming voltage drops below 11.2 V dc, the cellular modem does not turn on and will not turn on until the voltage is above 11.8 V dc. A text file (CmVMon.txt) on the internal micro SD card saves the periodic sampling of the incoming voltage. If cellular operation stops because of voltage, it is logged in this file.

There are four LED indicators that give the run/fault status for the DXM Wireless Controller. To view the processor board, open the housing top cover. Refer to [SAM4 Processor Board](#) on page 14 for LED locations. The four processor board LEDs indicate the following conditions:

- LED 1—Heartbeat; indicates the processor is running.
- LED 2—Indicates the cellular modem power cutoff is active. If the incoming power is less than 11.2 V, the cellular modem is powered down.
- LED 3—XML configuration file was rejected.
- LED 4—ScriptBasic program failed to load.

### 7.3 DXM Cellular Modem

---

The DXM cellular modem provides a remote network connectivity solution for the DXM Wireless Controller.

To use the cellular modem, first configure the DXM Wireless Controller to use the cellular network as the external network connection. Verify the cellular modem is installed and the correct antenna is connected to the cellular antenna port.

#### 7.3.1 Configure the DXM Wireless Controller for a Cellular Modem

Use the DXM Configuration Tool to create a configuration using a cellular connection. Under Settings > Cloud Services, define the Network Interface as Cell to have all push data, SMS messages, or email alerts to be sent using the cellular modem. The Cloud Push settings and the Webserver settings are required if the DXM Wireless Controller is sending data to a webserver.

The screenshot displays the configuration interface for the Sure Cross DXM150-Bx Wireless Controller. The 'Settings' tab is selected under the 'Cloud Services' section. The interface is divided into several panels:

- Network Interface:** Push interface is set to 'Ethernet'.
- Cell configuration:** Cell module is set to 'CE910'. There is an unchecked checkbox for 'Enable Server Mode'. Fields for APN, APN Username, and APN Password are present.
- Cloud Push:** Cloud push interval is set to 00:15:00, logging interval to 00:00:00, and push port to 80.
- Webserver Authentication:** There is an unchecked checkbox for 'Require Authentication'. Fields for Username and Password are present, along with a 'Send Authentication' button.
- Webserver:** Server name/IP is 'demopush.sensonix.net', Page is '/push.aspx', and Site ID is 'b3ce7448-b38b-4ea7-b994-17162a779eac'.
- HTTPS:** There is an unchecked checkbox for 'Use HTTPS' and a Certificate CN field with the value '\*.sensonix.net'.

When the DXM Wireless Controller is configured to use the cellular modem, the information on the cellular modem is found on the LCD menu under System Info > Cell. The menu does not display values until a transaction with the wireless cell tower is complete. If there are no webservice parameters defined, the user must force a push to retrieve the data from the cellular network. On the LCD menu, select Push > Trigger Data Push.

#### FW

Firewall IP address setting for VPN connection. The user enters the IP address of the host system on the other end of the VPN connection.

#### Mask

IP mask associated to the firewall IP address.

#### MEID

Mobile Equipment Identifier—a unique number for each cellular modem; this is the number the wireless carrier uses to attach a wireless plan.

#### MDN

Mobile Device Number—phone number.

#### Signal

Signal Strength between the cellular modem and the wireless network tower; this value ranges between -51 and -112 dBm. The more positive number is better, -51 is better than -81.

#### Version

Firmware version of the cellular modem; this can only be updated at the factory.

## 7.3.2 Cellular Activation Quick Start Guide

Sensonix CDMA cellular modems (based on the Telit CE910-DUAL) are ready to be activated when they leave the factory. Successful activation of every device on the cellular network requires two basic steps:

1. Attaching a data plan to the particular device
2. Completing Over-the-Air Service Provisioning (OTASP)

To attach a cellular data plan:

1. Select a data plan with a carrier that uses the Verizon network, working with Verizon directly or using an MVNO such as M2MAir or KORE Telematics.
2. Set up an account with the selected carrier.
3. When working with cellular devices you may be required to log into a web portal provided by the carrier and follow their instructions for device activation.
4. It is very important to make sure the carrier knows that the data plan is being attached to the device known as SENSX001.
5. Remove the DXM100 housing cover to see the cellular modem. Use the MEID printed on the Telit CE910-DUAL cellular modem to uniquely identify the device. The carrier requires this number to attach a monthly data plan.

To complete the Over-the-Air Provisioning (OTASP):

1. Once the contract is attached, the DXM Wireless Controller must provision the service using OTASP (Over-the-Air Service Provisioning).
2. Make sure the cellular module is plugged into the DXM Wireless Controller and has its antenna properly connected.
3. On the DXM Wireless Controller LCD display select menu: System and then Provision Cell.
4. Click Enter on the Provision Cell menu.
5. The next screen will ask if you want to provision the cellular device, click Enter.
6. It will take approximately 60 seconds and will indicate when it has completed.
7. The cellular modem is ready for use.

### 7.3.3 DXM Cellular VPN Setup

A software VPN tunnel can be created between a DXM Wireless Controller using a cellular modem to a host PC using a private IP or static wireless cellular plan. The instructions below outline the DXM Wireless Controller set up required to become aware of the VPN connection. The cellular plan provider will have separate instructions for setting up the VPN on the PC side.

1. Establish VPN tunnel on your computer. Instructions should be provided from your VPN provider.
2. From within the DXM Configuration Tool, go to Settings > Network > Cellular Firewall Settings..
3. Fill in the Firewall IP address and Firewall netmask provided by your VPN provider. For M2Mair this was included in the Routes.cmd file. It opens the device to traffic from 172.16.1.[0-255].
4. Go to Settings > Cloud Services > Network Interface.
5. Select Cell from the drop-down list and select the Enable VPN checkbox.
6. With your VPN tunnel open, select Device > Connection Settings.
7. Select TCP/IP, enter your VPN IP address, check VPN, and click Connect.

## 7.4 Accessing the DXM Using SMS

---

The DXM Wireless Controller with a cellular modem can be remotely accessed using SMS messages. Simple text messages can:

- Force a push to the cloud
- Reboot the controller
- Read/write local registers

The incoming firewall provides security; only defined phone numbers are permitted to access the controller. Use the DXM Configuration Tool to configure the SMS commanding feature. This feature requires firmware version 3.51 or later.

SMS command messages sent from approved phone numbers to the DXM Wireless Controller cause the DXM to respond. See the examples below for SMS responses. Responses may take 20 seconds or more, depending upon the network.

A DXM Wireless Controller requires a few minutes after powering up before it can accept SMS messages. Initial cellular connection times vary based on the wireless network. A SMS message sent to the controller while a push session is active delays any response or the SMS message may be dropped based on the length of the push session.

### 7.4.1 HTTP Push

Push triggers a http push to a webserver. The DXM Wireless Controller accepts the message, executes the action, and sends an acknowledgment text message back to the user.

Example: Texting `push` forces defined local registers to be sent to a webserver

```
push <send>
```

DXM Wireless Controller acknowledgment text message: `Register push requested`

### 7.4.2 Reboot

Reboot triggers the DXM Wireless Controller to reboot. The processor reloads the XML configuration file and zeroes all local register data. This does not affect the other components of the DXM Wireless Controller (ISM radio, I/O board, cellular modem). The DXM Wireless Controller accepts the message, executes the action, and sends an acknowledgment text message back to the user.

Example: Texting `reboot` forces the processor to reboot.

```
reboot <send>
```

DXM Wireless Controller acknowledgment text message: `rebooting...`

### 7.4.3 Get Register

grN gets register number N (DXM Local Register) and sends a text with the value back to the user. The response text message shows the value in floating point format regardless of register number.

Example: Text gr1 to retrieve the value for register 1.

gr1 <send>

DXM Wireless Controller acknowledgment text message: Register 1 is 0

### 7.4.4 Set Register

srN,X sets a register value, where N is the register number and X is the value. The DXM Wireless Controller responds with a SMS message indicating the register was set.

Example: Texting sr1,10 sets register 1 to value of 10

sr1,10 <send>

DXM Wireless Controller acknowledgment text message: Register 1 has been set to 10

### 7.4.5 Configuring the DXM Wireless Controller for SMS Controlling

Configure the DXM Wireless Controller for SMS messaging capability using the DXM Configuration Tool.

1. On the Settings > Cloud Services screen, set the network interface to Cell.
2. On the Settings > Network screen, enter the phone numbers that are allowed access to the DXM Wireless Controller.
3. Save the configuration file (File > Save).
4. Load the XML file to the DXM Wireless Controller.
5. After the device has been running for a few minutes, the cellular network should be operational. The phone number (MDN) is visible on the DXM LCD menu (System Info > Cell).
6. Send a text message to the DXM Wireless Controller from an approved phone number.

## 8 LCD and Menu System

The LCD has four user-defined LED indicators, four control buttons, and an LCD display. The four buttons control the menu system on the LCD menu.

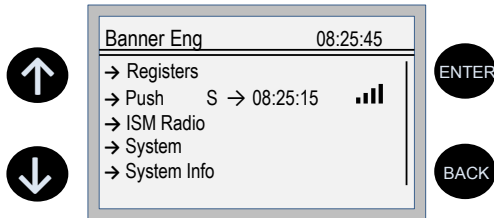

The top-level menu always displays the time in a 24-hour format.

- The up and down arrows scroll through display items.
- The enter button selects the highlighted items on the display
- The back button returns to a previous menu option.

The left display column shows an arrow at the beginning of the line if the menu has submenus. The right column shows a vertical line with an arrow at the bottom if the user can scroll down to see more menu items.

### 8.1 Registers

The Registers submenu displays the processor's local registers that can be configured using the DXM Configuration Tool.

To configure these local registers, launch the DXM Configuration Tool. Go to Local Registers and expand the view for a local register by clicking on the down arrow next to the register number. In the LCD Permissions field, select None, Read, Write, or Read/Write.

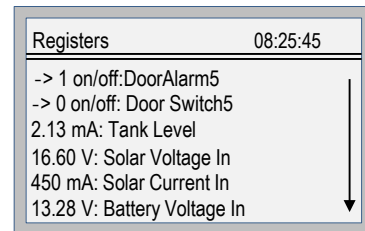

Read allows the register to be displayed, and Write or Read/Write allows the register value to be changed using the LCD. The Units and Scaling parameters are optional and affect the LCD.

### 8.2 Push

The Push menu displays information about the last data sent to the Webservice.

The user can force an immediate push to the webserver using Trigger Push. If a current push is in process it may take several minutes to complete over cellular.

- The Trigger Push submenu forces an immediate push to the web server.
- The status and time fields indicate success or failure of the last attempted push and time of the last attempted push.

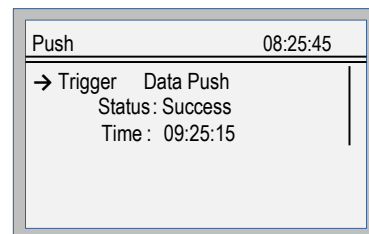

### 8.3 ISM Radio

The ISM Radio menu allows the user to view the Modbus ID of the internal ISM radio, invoke binding, or run a site survey. To change the ISM Radio Modbus ID refer to the System menu.

The top level menu includes a read-only ISM Radio menu selection. This menu displays the type of radio in the DXM Wireless Controller (MultiHop or DX80 Star) and the Modbus ID of the radio.

This menu only allows the user to view this data. Binding or Site Survey with the internal radio is also run from this menu selection. This top-level ISM Radio menu is different from the System > ISM Radio submenu.

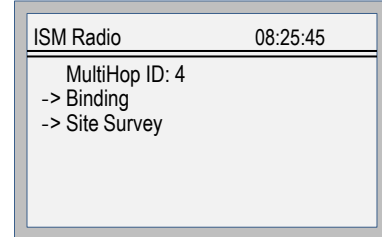

**Binding**— All ISM radio devices must be bound to the internal Gateway/master device before the DXM Wireless Controller can access the wireless devices. The first submenu under binding allows the user to set the wireless address of the device to bind with. This is required to bind with wireless devices that do not have rotary dials (for example: M-GAGEs, Ultrasonic sensors, and Q45 devices).

To bind:

1. Enter the Binding menu.
2. For devices without rotary dials, select the wireless device number.
3. Enter binding mode. The gateway/master radio enters binding mode.
4. Triple-click the wireless Node/slave device to put it into binding mode. The LEDs indicate when binding on the wireless device is completed.

For more information of the binding of a particular device review the individual datasheet.

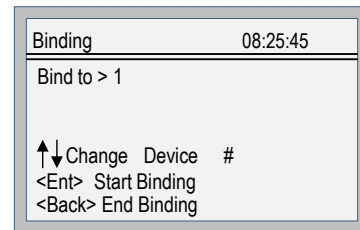

**Site Survey**— After creating a wireless network using the binding process, run a site survey on each device to see the link quality.

1. Enter the Site Survey menu.
2. Select the Node or Slave ID for the end device.
3. Click Enter to run a site survey.

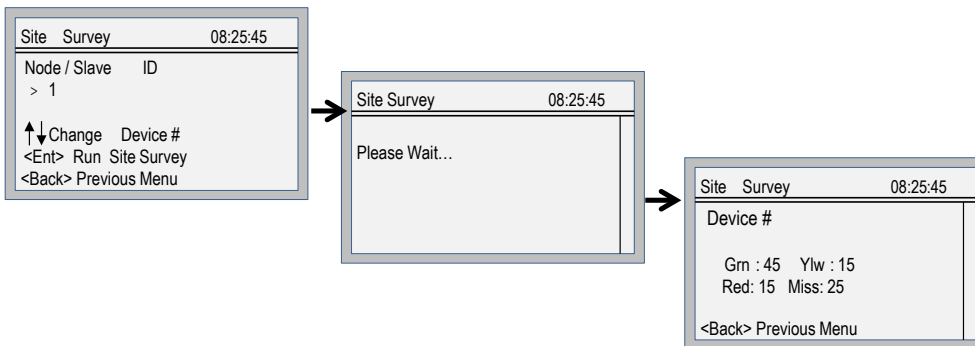

The Site Survey results display as green, yellow, red, and missed packets. Green indicates the highest signal strength, then yellow, and red. Missed packets failed to be received. The DX80 system can run a site survey analysis while the network is operational. A MultiHop device runs with its parent device and does not allow other traffic when a site survey is running.

## 8.4 System

Use the System menu to set DXM Wireless Controller system parameters.

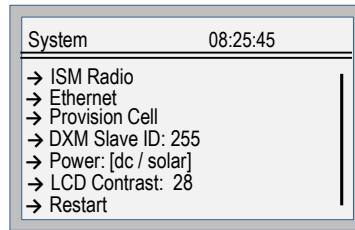

### 8.4.1 ISM Radio

The internal ISM radio of the DXM Wireless Controller is set at the factory to be Modbus device address 1 (Modbus ID 1).

For some applications, you may need to change this ID. The best way to adjust the Modbus device address is by using the LCD menu system of the DXM Wireless Controller. Any other method may cause issues with the DXM Wireless Controller not knowing which Modbus device address is assigned to the radio, which causes issues with running Binding or Site Survey from the LCD menu.

To setting the Modbus ID on the internal radio, select the System > ISM Radio menu. There are two options: Modbus ID and Advanced Options.

**Modbus ID**—Set the ISM Modbus ID to any number (1 through 247) not being used by the DXM system. Processor Local Registers allocate ID 199, the I/O board is set to ID 200, and the display board is set to ID 201. With a DX80 Star Gateway device, it's easy to choose a new ID. With a MultiHop network, remember that the master MultiHop radio allocates a range of Modbus IDs for wireless devices, typically 11 through 110.

When setting the new ISM Modbus ID, the system changes the Modbus ID on the internal radio and changes the reference to it on the DXM Wireless Controller. The reference Modbus ID is what the DXM Wireless Controller uses to access the internal radio when running Binding or Site Survey.

**Advanced Options**—The Advanced Options menu is typically not used unless the Modbus ID is changed without the DXM Wireless Controller being involved, such as when you write directly to the radio Modbus registers.

If the internal Modbus ID of the radio was changed, but not recorded, use Auto Detect Radio to determine the radio ID. The auto detect routine broadcasts discovery messages and waits for a response. If devices are connected to the external RS-485 ports, they may need to be disconnected for this process to work properly.

**Reference Type** selects the radio type between DX80 Star architecture radios and a MultiHop radio. The DXM Wireless Controller uses this reference to determine how to communicate to the internal radio. If set incorrectly, the DXM Wireless Controller may not be able to run Site Survey from the LCD menu. Unless you are changing or adding the internal radio device there should no reason to change the radio type.

The Reference Modbus ID defines the Modbus ID the DXM Wireless Controller uses when communicating with the internal radio. If this is set incorrectly the DXM Wireless Controller will not be able to run Binding or Site Survey through the LCD menu.

### 8.4.2 Ethernet

Use the System > Ethernet menu to set the IP Address, Gateway Address, and Subnet mask of the DXM Wireless Controller's Ethernet interface. You may change these settings either from the LCD menu (System > Ethernet) or from the XML configuration file created by the DXM Configuration Tool.

The network address settings from the LCD menu have the highest priority and override settings in the XML configuration file. To use the parameter settings from the XML configuration file or use DHCP, execute the Reset under System > Ethernet or use the LCD display to set the IP Address, Gateway Address, and Subnet Mask to 255.255.255.255. Reboot the DXM Wireless Controller after changing the Ethernet parameters.

The Ethernet cable should be attached before powering up the DXM Wireless Controller.

### 8.4.3 Provision Cell

If the DXM Wireless Controller has a cellular modem installed, the modem must be provisioned on the network. This menu will provision the cellular modem on the network. For step by step directions, see [DXM Cellular Modem](#) on page 50.



## 8.4.4 DXM Slave ID

Use the secondary Modbus RS-485 port when the DXM Wireless Controller is connected to a Modbus RTU network as a Modbus slave device. Set the Modbus ID for the secondary RS-485 port using the LCD display menu System > DXM Slave ID.

## 8.4.5 Power DC/Solar

The DC/Solar parameter selects the charging algorithm for batteries attached to the DXM Wireless Controller. The factory default setting is DC.

Set the charging algorithm to Solar when the main power source is a solar panel and batteries. Set the battery charging algorithm to DC when the main power source is line powered 10–30 V dc and the attached batteries are used as backup batteries. This setting can also be set by writing Modbus register 6071 of the I/O board. See [Supplying Power from a Solar Panel](#) on page 20.

## 8.4.6 LCD Contrast

Use the LCD Contrast option to adjust the LCD contrast. Adjust the starting number lower to decrease the display contrast. The factory default is 28. Do not set a number less than 14 or the display may not be bright enough to see to change back.

## 8.4.7 Restart

Use Restart to force the main processor to restart. This does not affect the other boards in the system, I/O board, ISM radio board, or Cellular modem.

## 8.5 System Info

Various DXM system settings are shown in this menu. The Push, Ethernet, and Cell parameters are helpful for debugging network connections. This menu is a read only menu.

### Cell

Shows the cellular MEID number (Mobil Equipment Identifier), MDN (Mobil Device Number), version, signal, firewall setting, and firewall mask. Some of these parameters are not visible until the cellular network is accessed.

### Controller

Displays the date, build, model, and serial number.

### Ethernet

Displays the IP address, MAC address, DHCP, Gateway address, and DNS settings.

### I/O Board

Displays the serial number, model, date, firmware part numbers, and version numbers.

### ISM Radio

Displays the serial number, model, date, firmware part numbers, and version numbers.

### LCD Board

Displays the serial number, model, date, firmware part numbers, and version numbers.

### Push

Shows the current parameters loaded from the XML configuration that applies to pushing data to a webserver, including method (Ethernet or cellular), interval, URL, page, HTTPS, and site ID.

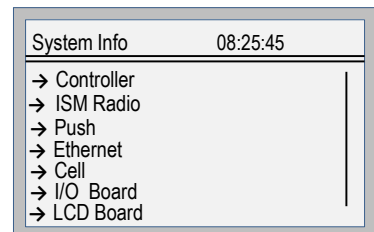

## 8.6 Using the Display LEDs

Turn on the DXM Wireless Controller LEDs by writing to the LEDs' Modbus registers.

The DXM display uses Modbus slave ID 201 and has four individual registers for each of the four LEDs on the display.

Turn on an LED by writing a 1 value to the register. Turn off the LED by writing a 0 to the register.

Do not write to any other Modbus registers. They are used by the LCD display for menu data.

Display Modbus Register	Display LED
1102: bit 0	LED 1 (Green)
1103: bit 0	LED 2 (Red)
1104: bit 0	LED 3 (Yellow)
1105: bit 0	LED 4 (Red)

### DXM Wireless Controller Display Example

This example shows setting up the DXM Wireless Controller using the DXM Configuration Tool to read four universal inputs and write the state values to the display LEDs.

1. Using the DXM Configuration Tool, go to the Local Registers > Local Register Configuration screen.
2. Define the local registers by assigning names to the first four registers and setting the LCD permissions parameter to read/write. The LCD permissions show the register contents on the LCD menu under the REGISTER menu. You can also set the value from the LCD menu.

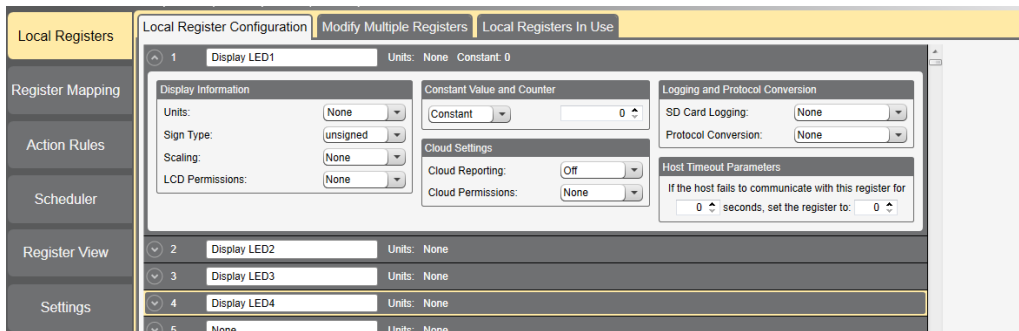

3. Create a Read Rule to read the four universal inputs from the I/O board (Modbus slave 200) and write the values in local registers 1 through 4.



4. Create a Write Rule to write the four local register values to the DXM display registers 1102 through 1105 (Modbus Slave 201). Define the Write Rule to only write the display registers when the inputs change.

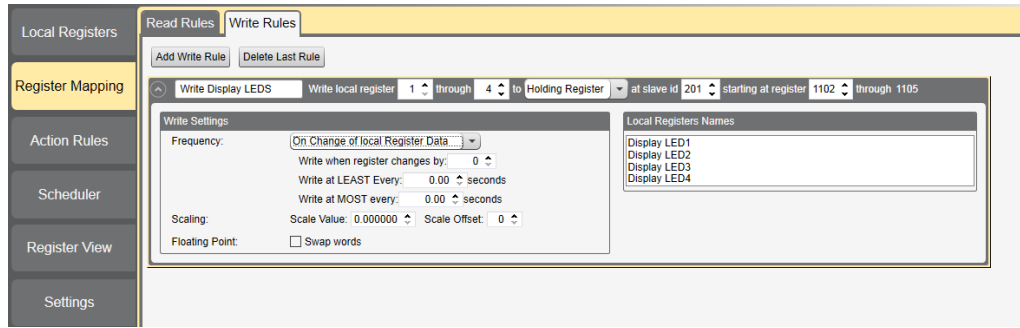

5. Save the XML configuration from the File > Save As menu.
6. Connect to the DXM Wireless Controller using a USB cable and select Device > Connection Settings from the menu bar.
7. Upload the XML configuration file to the DXM Wireless Controller by selecting Device > Upload Configuration to Device from the menu bar.

After a configuration file is uploaded, the DXM Wireless Controller reboots. The new configuration is now running.

Turning on any one of the universal inputs 1 through 4 on the I/O base board of the DXM Wireless Controller now turns on an LED on the display.

On the DXM Wireless Controller's LCD menu, the arrow on the left side of the register line indicates this local register can be written to. Try changing the configuration to delete the Read Rule then turn on/off the LEDs by changing the register value through the LCD display.

## 8.7 Modbus Registers for the LCD Board (Modbus Slave ID 201)

Control the four user-defined LEDs using the display board's Modbus registers. Using write maps or ScriptBasic, write the Modbus registers shown below with 0 (off) or 1 (on). The LCD display is Modbus Slave 201.

Modbus Register	I/O Connection	Modbus Register	I/O Connection
1102 : bit 0	LED 1	1104 : bit 0	LED 3
1103 : bit 0	LED 2	1105 : bit 0	LED 4

## 9 Working with Modbus Devices

### 9.1 Overview

The DXM Wireless Controller has two physical RS-485 connections using Modbus RTU protocol.

The master Modbus RS-485 port is for the DXM Wireless Controller to act as a Modbus master device to control internal and external Modbus slave devices.

The Modbus master RS-485 port is labeled M+ and M- on the DXM Wireless Controller. The Modbus slave port is used when another Modbus master device wants to communicate with the DXM Wireless Controller when the DXM Wireless Controller is a Modbus slave device.

The Modbus slave RS-485 port is labeled S+ and S1 on the DXM Wireless Controller.

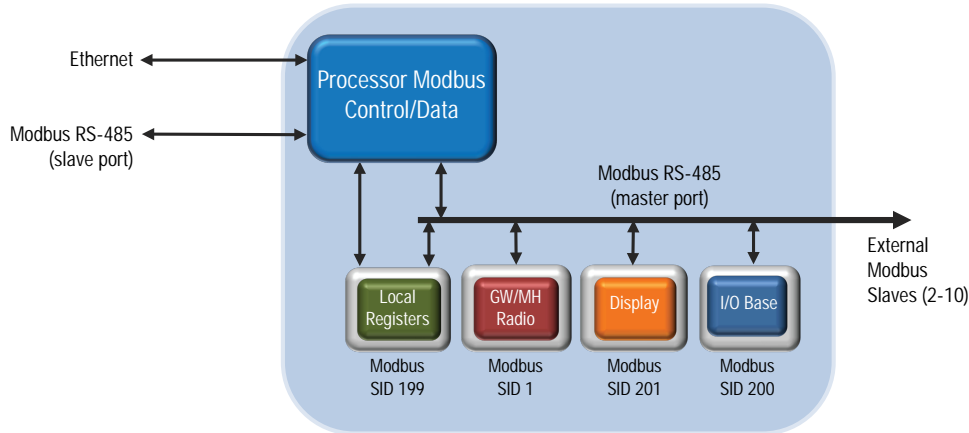

The DXM Wireless Controller has dual Modbus roles: a Modbus slave device and a Modbus master device. These run as separate processes.

The Modbus slave port can only access the DXM Wireless Controller local registers. To operate as a Modbus slave device, the DXM Wireless Controller needs to be assigned a unique Modbus slave ID as it pertains to the host Modbus network. This slave ID is separate from the internal Modbus slave IDs the DXM Wireless Controller uses for its own Modbus network. The DXM Modbus slave ID is defined through the LCD menu. Other Modbus slave port parameters are defined by using the DXM Configuration Tool.

The DXM Wireless Controller operates the Modbus master port. Each device on the master port must be assigned a unique slave ID. There are slave IDs that are reserved for internal devices in the DXM Wireless Controller.

DXM Internal Modbus Slave IDs (factory default)	
Modbus Slave ID	Device
1	Gateway (PE5) or MultiHop (HE5) ISM Radio—MultiHop wireless devices connected to the internal MultiHop radio should be assigned Modbus Slave addresses starting at 11.
199	Local Registers—Internal storage registers of the DXM Wireless Controller
200	I/O Base Board—All data and parameters for each input or output of the DXM Wireless Controller.
201	LCD Display—The user has access to the LED indicators on the DXM Wireless Controller.

### 9.2 Assigning Modbus Slave IDs

Assign the DXM Modbus Slave ID only if a Modbus master device is reading or writing the DXM Wireless Controller Local Register data through the Modbus RS-485 slave port (S+, S-).

Set the DXM Slave ID from the LCD menu under System > DXM Slave ID. The DXM Wireless Controller can have any unique slave ID between 1 and 246, depending upon the host Modbus network. Other RS-485 slave port parameters are set in the DXM Configuration Tool under the Settings > General tab.

**DXM Master Configuration**—When the DXM Wireless Controller operates as a Modbus master device, use the DXM Configuration Tool to configure read or write operations of the DXM Modbus network. The DXM Wireless Controller communicates with all internal and external peripheral devices using the external Modbus bus RS-485 (M+, M-)

There are four internal Modbus slave devices that are configured from the factory with slave IDs. Assign slave IDs of 2 through 10 to Modbus slave devices that are physically wired to the DXM Wireless Controller. Assign slave IDs or 11 through 60 to wireless slaves within the MultiHop network.

Do not assign a slave ID of greater than 10 to Modbus slave devices that are physically wired using the RS-485 port if there is an internal MultiHop ISM radio in the DXM Wireless Controller. The MultiHop ISM radio attempts to send any Modbus data intended for slaves 11–60 across the radio network, which conflicts with wired slave devices if the slave IDs overlap. The MultiHop master radio can be changed from the factory default of 11–60 Modbus slave IDs if more hardwired slaves are required.

## 9.3 Modbus Operation

All Modbus transactions are managed by a central Modbus engine. If there are Modbus messages intended for a Modbus slave that doesn't exist, the Modbus engine waits for a response until the timeout period is expired. This slows down the Modbus polling loop for read and write operations. For this reason, verify all Modbus read and write operations are intended for Modbus slave devices that are in the network.

If a Modbus slave is not in the network, either a wired or wireless device, the operation of the LCD menu system can be compromised. Operations like Binding, Site Survey, or accessing the ISM menu may be slower. This is because all internal devices of the DXM Wireless Controller are also Modbus slaves, ISM radio, I/O base board, LCD, and internal Local registers.

## 9.4 Wireless and Wired Devices

**Wireless DX80 Gateway**—The DX80 Gateway architecture is a star architecture in which all Nodes in the system send their data back to the Gateway. The host can access the entire network data from the Gateway, which is Modbus slave ID 1. Because the DXM Wireless Controller will not be sending any Modbus messages across the wireless link, the timeout parameter can be set low (less than 1 second) and the device is treated like a directly connected device.

**MultiHop Master**—The MultiHop master radio forms a wireless tree network using repeaters and slave devices. Each device in a MultiHop network must be assigned a unique Modbus Slave ID and is accessed as a separate device.

For the DXM Wireless Controller to talk with a MultiHop device in the wireless network, the master MultiHop device interrogates every message on the RS-485 bus. If they are within the wireless devices range (slave IDs 11 through 60), the message is sent across the wireless network. To change this range, the user must adjust the offset and range setting in the MultiHop master radio (Modbus Slave ID 1). Modbus register 6502 holds the Modbus offset, default 11. Modbus register 6503 holds the number of Modbus slaves allowed (maximum of 100).

Modbus Slave ID	Description
1	Allocated for the internal ISM radio device, either a DX80 Gateway or MultiHop Master
2–10	Slave addresses available for direct connected Modbus slave devices to the master RS485 port (M+ , M-)
11–60	Allocated for wireless MultiHop radio network devices. If there is not an internal MultiHop in the DXM Wireless Controller, these slave addresses are available to use for directly connected devices.
61–198	Available to user for direct connected Modbus slave devices or the expansion of the wireless network slave IDs to go past 50 wireless devices.
199	Allocated for internal Local Register
200	Allocated for the I/O base board, will be different for special DXM slave only models.
201	Allocated for the LCD display board, the user can read/write LEDs.

## 9.5 Modbus Timeouts

A Modbus timeout is the amount of time a Modbus slave is given to return an acknowledgement of a message sent by the Modbus master. If the Modbus master waits for the timeout period and no response is seen, the Modbus master considers it a lost message and continues on to the next operation.

The timeout parameter is simple to set for Modbus devices directly connected to the DXM controller, if there are no MultiHop wireless devices. If a MultiHop network a part of the DXM Wireless Controller, special considerations need to be made to set the timeout parameter.

Wireless communications are inherently lossy networks, and controllers operating these networks must be configured to allow for enough time for hardware transmission retries. Set the Communications Timeout parameter to cover the expected time for messages to be sent throughout the wireless network. For the DXM Wireless Controller, the Communications Timeout parameter is the maximum amount of time the DXM Wireless Controller should wait after a request is sent until the response message is received from the Modbus slave device. Use the DXM Configuration Tool to set the timeout parameter on the Settings > General screen.

The default setting for the timeout parameter is 5 seconds.

### 9.5.1 MultiHop Networks vs DX80 Star Networks

The DX80 star Gateway collects all the data from the Nodes, which allows the host system to directly read the data from the Gateway without sending messages across the wireless network. This allows for DX80 Gateway to be treated like any other wired Modbus device.

In a MultiHop network, the data resides at each device, forcing the controller to send messages across the wireless network to access the data. For this reason, carefully consider the value of the wireless timeout parameter.

### 9.5.2 MultiHop Radios Powered by Battery

Battery-powered MultiHop radios are configured to run efficiently to maximize battery life. By optimizing battery life, the allowed communications window for receive messages is slow (once per 1.3 seconds) and sending message rates are standard (once per 0.04 seconds).

A MultiHop device is set from the factory with the retry parameter set to 8. This means that under worst-case conditions, a message is sent from the DXM Wireless Controller to an end device a total of nine times (one initial message and eight retry messages). The end device sends the acknowledgment message back to the DXM Wireless Controller a maximum of nine times (one initial message and eight retries). A single Modbus transaction may send up to two messages + 16 retry messages before the transaction is complete. In addition, the radios randomly wait 0–1 time period before retransmitting a retry message. So to allow for the random wait time, add one extra time period for each in-between time of retries.

For a Master radio to a slave radio (no repeaters):

- Master to Slave Send time =  $(9 \times 1.3 \text{ sec}) + (8 \text{ retry wait} \times 1.3 \text{ sec}) = 22 \text{ seconds}$
- Slave to Master Send time =  $(9 \times 0.04 \text{ sec}) + (8 \text{ retry wait} \times 0.04 \text{ sec}) = 1 \text{ second}$
- Total Send/Receive time = 23 seconds
- Minimum Timeout period = 23 seconds

This calculates the maximum timeout value for a wireless transaction. If the link quality of the network is poor, the maximum transfer times may happen. Set the timeout parameter to accommodate the maximum number of retries that may happen in your application.

When MultiHop repeaters are added into the wireless network, each additional level of hierarchical network increases the required timeout period. Since MultiHop repeaters are running at the highest communications rate, the overall affect is not as great.

- Master to Repeater Send time =  $(9 \times 0.04 \text{ sec}) + (8 \text{ retry wait} \times 0.04 \text{ sec}) = 1 \text{ second}$
- Repeater to Master Send time =  $(9 \times 0.04 \text{ sec}) + (8 \text{ retry wait} \times 0.04 \text{ sec}) = 1 \text{ second}$
- Additional Timeout period for a repeater = 2 seconds

Using the timeout calculation above of 23 seconds, if a repeater is added to the network the timeout should be set to 25 seconds. For each additional MultiHop repeater device creating another level of network hierarchy, add an additional two seconds to the timeout period.

### 9.5.3 MultiHop Radios Powered by 10-30 V DC

Line-powered (10–30 V dc) MultiHop devices operate at the maximum communication rate, resulting in a much lower timeout parameter setting. For each repeater added to the network, increase the timeout parameter 2 seconds.

For a Master radio to a 10–30 V dc powered slave radio (no repeaters):

- Master to Slave Send time =  $(9 \times 0.04 \text{ sec}) + (8 \text{ retry wait} \times 0.04 \text{ sec}) = 1 \text{ second}$
- Slave to Master Send time =  $(9 \times 0.04 \text{ sec}) + (8 \text{ retry wait} \times 0.04 \text{ sec}) = 1 \text{ second}$
- Total Send/Receive time = 2 seconds
- Minimum Timeout period = 2 seconds

### 9.5.4 Adjusting the Receive Slots and Retry Count Parameters

The number of receive slots governs how often a MultiHop device can communicate on the wireless network.

Battery-powered devices typically have DIP switches that allow the user to set the number of receive slots. (This will directly affect the battery life of the device.) Adjusting the receive slots changes how often a message can be received. In the battery power example (default factory settings) the receive slots are 1.3 seconds (receive slots = 4). With the receive slots set to 32, how often a message can be received goes from 1.3 seconds down to 0.16 seconds.

An argument can be made to allow the application accessing the wireless network, in this case the DXM Wireless Controller, to control the retry mechanism. The number of retries can be adjusted in the MultiHop devices by writing Modbus register 6012 to the number of retries desired. The factory default setting is eight.

### 9.5.5 DX80 Star Architecture Network Timeouts

In the DX80 network, all Node data is automatically collected at the Gateway to be read. The DXM Wireless Controller does not use the wireless network to access the data, which allows for much faster messaging and much lower timeout values.

For a DXM Wireless Controller with an internal DX80 Gateway, set the timeout value 0.5 seconds. If other Modbus slave devices are connected to the RS-485 lines, the timeout parameter will govern all communication transactions and must be set to accommodate all devices on the bus.

# 10 Configuration Instructions

## 10.1 Scheduler

Use the Scheduler screen to create a calendar schedule for local register changes, including defining the days of the week, start time, stop time, and register values. Schedules are stored in the XML configuration file, which is loaded to the DXM Wireless Controller. Reboot the DXM Wireless Controller to activate a new schedule.

### 10.1.1 Creating a Weekly Schedule

Use the Weekly Events screen to define weekly events.

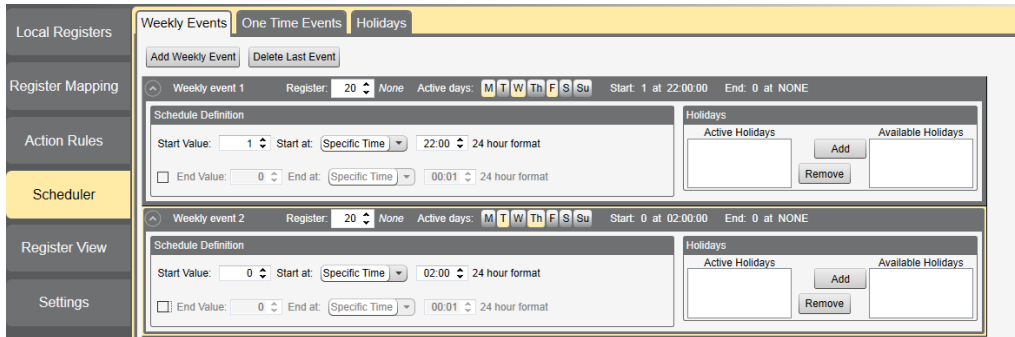

To create a new rule:

1. Click Add New Rule.
2. Click on the arrow to the left of the new rule to expand the parameters into view.
3. Enter the local register.
4. Select the days of the week this rule applies to.
5. Use the drop-down list to select the type of Start At time: a specific time or a relative time.
6. Enter the starting time.
7. Enter the starting value for the local register.
8. Enter the end time and end value for the local register.

Register updates can be changed up to two times per day for each rule. Each rule can be set for any number of days in the week by clicking the buttons M, T, W, Th, F, S, or Su.

If two register changes are defined for a day, define the start time to be before the end time. Select End Value to enable the second event in a 24 hour period. To span across two days (crossing the midnight boundary), set the start value in the first day, without selecting End Value. Use the next day to create the final register state.

Start and end times can be specified relative to sunrise and sunset, or set to a specific time within a 24 hour period. When using sunrise or sunset times, set the GPS coordinates on the device so it can calculate sunrise and sunset.

### 10.1.2 Defining One-Time Events

Define one-time events to update registers at any time within a calendar year. Similar to Weekly events, the times can be specific or relative to sunrise or sunset. Define one-time events using the one-time events screen.

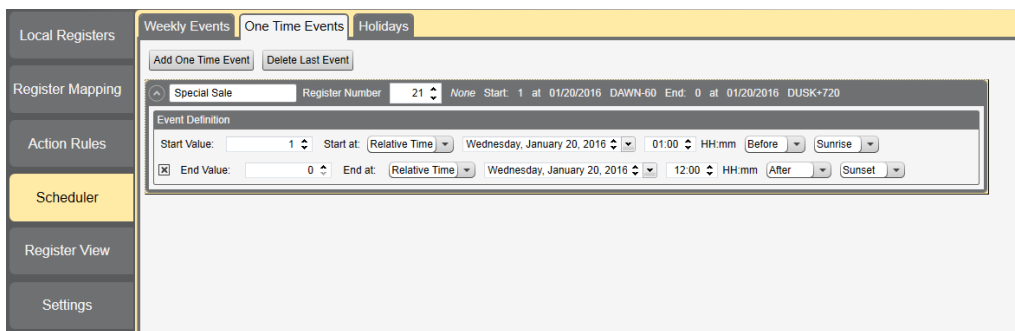

To create a one-time event rule:



1. Click on Add One Time Event.
2. Name your one-time event by clicking on the name link and entering a name.
3. Click on the arrow to expand the parameters into view.
4. Enter the local register.
5. Enter the starting time, date, and starting value for the local register.
6. Enter the ending time, date, and ending value for the local register.

### 10.1.3 Creating a Holiday Schedule

Use the Create Holidays screen to create exception conditions that alter the standard scheduled register changes.

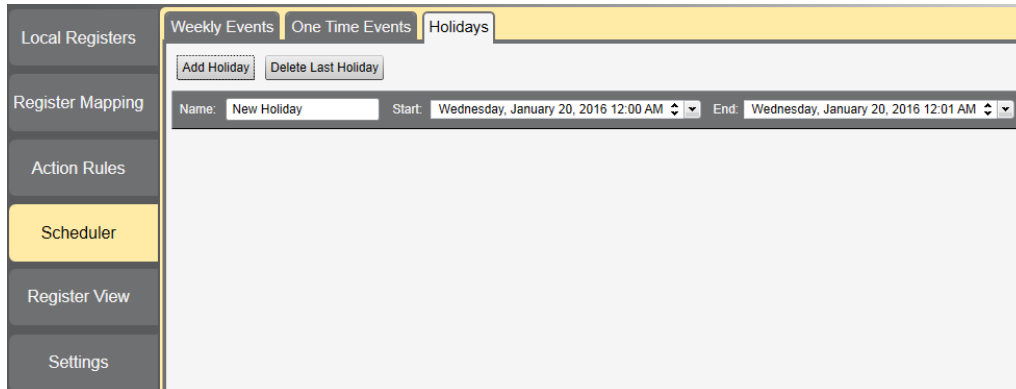

To create a holiday:

1. Click on Add New Rule.
2. Name your new holiday by clicking on the name link and entering a name.
3. Select the start date and time for the new holiday.
4. Select the stop date and time for the new holiday.

### 10.1.4 Cycling Power During Schedules

If power is cycled to the DXM Wireless Controller in the middle of a schedule, the DXM Wireless Controller looks at all events scheduled that day and processes the last event before the current time.

## 10.2 Authentication Setup

The DXM Wireless Controller has three different areas that can be configured to require a login and password authentication.

- Webservice/ Cloud Services Authentication
- Mail Server Authentication
- DXM Configuration Authentication

The webservice and mail server authentication depends upon the service provider.

### 10.2.1 Cloud and Webservice Services Authentication

The DXM Wireless Controller can be configured to send login and password credentials for every HTTP packet sent to the webservice. This provides another layer of security for the webservice data.

Setup requires both the webservice and the DXM Wireless Controller to be given the same credentials for the login and password. The webservice authentication username and password are not stored in the XML configuration file and must be stored in the DXM Wireless Controller.

Define the login and password using the Settings > Cloud Services screen of the DXM Configuration Tool, in the Webservice Authentication section of the screen.

The first time you select Require Authentication, a pop-up box appears with additional instructions. Since the data is not stored in the XML configuration file, it is hidden from view of the DXM Configuration Tool.

After enter the username and password, click on Send Authentication to transmit the data directly to the DXM Wireless Controller's non-volatile memory. The controller must be connected to the PC for this operation to succeed. If successful, a pop-up window appears, asking to reboot the device. Select Yes to reboot the device.

Set up the webserver with a username and password to accept the DXM Wireless Controller messages. Otherwise, the webserver ignores all messages.

When using the Sensonix website's dashboard, set the authentication by clicking the edit button next to the appropriate site name. Enter the Username and Password, then click Save to save your changes.

### 10.2.2 Mail Server Authentication

Complete the mail server settings to have the DXM Wireless Controller send email alert messages or to email the log files. The SMTP password is stored in the DXM Wireless Controller, not the XML configuration file. Use the Settings > Mail and Messaging screen to complete this configuration.

After selecting Enable SMTP Authentication for the first time, a pop-up box appears with additional instructions to complete the mail server authentication process.

After entering the user name and password, click on Send SMTP Password to save the user name and password to the DXM Wireless Controller. The DXM Wireless Controller must be connected to the PC to complete this operation. If successful, a pop-up window appears, asking to reboot the device. Select Yes to reboot the device.

### 10.2.3 DXM Wireless Controller Configuration Authentication

The DXM Wireless Controller can be programmed to allow changes to the configuration files only with proper authentication by setting up a password on the Settings > Administration screen in the DXM Configuration Tool.

With the DXM Wireless Controller connected to the PC, click Get Device Status. The DXM Wireless Controller status displays next to the button.

The screenshot shows the Administration tab of the DXM Configuration Tool. The left sidebar contains the following menu items: Local Registers, Register Mapping, Action Rules, Scheduler, Register View, and Settings (highlighted in yellow). The main content area is divided into two sections:

- File Protection:** Contains a 'Get Device Status' button with the value 'Unknown', a 'Current Admin Password' text input field, an 'Action' dropdown menu, and a 'Submit' button.
- Bootloader:** Contains a 'Comm Port' dropdown menu with a refresh icon, a 'File Path' text input field with a file selection icon, and a 'Bootload' button.

Use the DXM Configuration Tool to:

- Set the Admin Password
- Change the Admin Password
- Remove the Admin Password

To change or remove an admin password, the current password must be supplied. The DXM Wireless Controller must be connected to the PC to change the administration password.

The DXM Wireless Controller can be unlocked without knowing the administration password, but doing this erases the configuration program, logging files, and any ScriptBasic program on the device.

To unlock the hardware without knowing the administration password:

1. Turn off the power to the DXM Wireless Controller.
2. Open the controller top to access the button and DIP switches of the SAM4 processor board.
3. Turn on DIP switch 4 (next to the SD card holder).
4. Press and hold the reset button (next to the USB jack) while applying power to the DXM Wireless Controller.
5. Release the reset button.
6. After five seconds, turn off the power.
7. Turn off DIP Switch 4.
8. Install the DXM cover and apply power.

The device no longer has an administration password set.

## 10.3 Register Flow and Configuration

The DXM Wireless Controller register data flow goes through the Local Registers, which are data storage elements that reside within the processor. Using the DXM Configuration Tool, the controller can be programmed to move register data from the Local Register pool to remote devices, the internal radio, the I/O base, or the display.

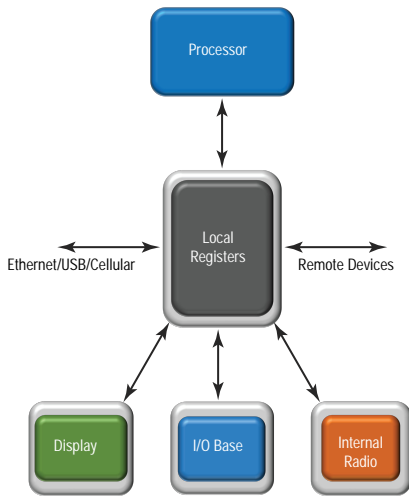

### 10.3.1 Basic Approach to Configuration

When programming an application in the DXM Wireless Controller, the first step is to plan the overall data structure of the Local Registers.

The Local Registers are the main storage elements in the DXM Wireless Controller. Everything goes into or out of the Local Registers. Start by naming the Local Registers in the application as this helps to provide the beginning structure of the application.

After you have a basic idea what data values to store, configure the read/write rules to move the data. The Read/Write rules are simple rules that move data between devices and the Local Registers.

Most applications require the ability to manipulate the Local Register data, not just move data around. Use the Action rules to make decisions or transform the data after the data is in the Local Registers. Action rules can apply many different functions to the Local Register data, including conditional statements, math operations, copy operations, or trending.

To perform scheduled events in Local Registers, look under the Scheduler tab in the DXM Configuration Tool. These rules provide the ability to create register events by days of the week. The scheduler can also create events based on sunrise or sunset.

### 10.3.2 Troubleshooting a Configuration

The built-in Register View utility is found in the DXM Configuration Tool on the Register View screen.

When a configuration is running on the DXM Wireless Controller, this utility can read or write Local Registers to help understand application operation. The utility can also access data from remote devices, making it easier to troubleshoot a configuration.

Local Registers can also be configured to show register data on the LCD menu to view Local Register data without having the controller connected to a PC. On the Local Registers tab, set the read permissions on each register to be display on the LCD.

### 10.3.3 Saving and Loading Configuration Files

The DXM Configuration Tool saves its configuration information in a XML file. Use the File menu to Save or Load configuration files.

Save the configuration file before attempting to upload the configuration to the DXM Wireless Controller. The DXM Configuration Tool uploads the configuration file saved on the PC to the DXM Wireless Controller; it will not send the configuration loaded in the tool.

### 10.3.4 Uploading or Downloading Configuration Files

The DXM Wireless Controller requires a XML configuration file to become operational. To upload or download configuration files, connect a computer to the DXM Wireless Controller using the USB port or Ethernet port. Then use the Upload Configuration to Device or Download Configuration from Device under the Device menu.

## 10.4 Setting Up EtherNet/IP™

The DXM Wireless Controller is defined from the factory to send/receive register data from the Gateway and the first 16 Nodes with an EtherNet/IP™<sup>7</sup> host. To expand the number of devices going to Ethernet/IP the user must change the Maximum Node count parameter in the DX80 Gateway from 16 to 32. Use the DX80 Configuration Tool to set this parameter.

This allows the user to maximize the use of the EtherNet/IP buffer to 28 devices. To expand the number of devices further, customize the data collection for EtherNet/IP using the DXM Configuration Tool and only selecting the needed registers. A maximum of 228 registers can be read or written with Ethernet/IP.

EDS (Electronic Data Sheet) files allow users of the EtherNet/IP protocol to easily add a Banner DXM device. Download the EDS files from the Banner website.

### 10.4.1 Configuring the Host PLC

On the host PLC, install the DXM Wireless Controller using an EDS file or by using the following parameters:

- Assembly1: Originator to DXM = Instance 112, 456 bytes (228 words)
- Assembly2: DXM to Originator = Instance 100, 456 bytes (228 words)

The Originator is the host PLC system, and the DXM is the DXM Wireless Controller. The host system sees the DXM Wireless Controller as a generic device with the product name of Banner DXM (ProdType: 43 - Generic Device, ProdName: Banner DXM).

### 10.4.2 Configuring the DXM Wireless Controller

Use the DXM Configuration Tool to define each local register to be Originator -> DXM or as a DXM -> Originator.

- Define a DXM local register as Originator -> DXM when the host PLC (Originator) will send data to the DXM Wireless Controller local register (DXM).
- Define a DXM local register as DXM -> Originator when that register data will be sent from the DXM Wireless Controller (DXM) to the host PLC (Originator).

Data from an EIP controller in assembly instance 112 is data destined for the DXM Wireless Controller local registers. The first two bytes of the assembly instance are stored in the first local register defined as an Originator -> DXM register. The next two bytes of the assembly instance are stored in the next local register defined as an Originator -> DXM register. For example, if DXM local registers 5, 12, 13, and 15 are configured as Originator -> DXM, the first eight bytes (four words) of data from the assembly instance are stored into these registers in order (5, 12, 13, and 15). The system ignores the rest of the bytes in the assembly instance.

Data from the DXM Wireless Controller local registers is sent to the EIP controller using assembly instance 100. Each local register in the DXM Wireless Controller defined as DXM -> Originator is collected in numerical order and placed into the data buffer destined for assembly instance 100. DXM local registers are capable of 32-bits, but only the lower 2-bytes for each local register are transferred. For example, if DXM registers 1, 10, 20, and 21 are defined as DXM -> Originator registers, the assembly instance 100 will have the first eight bytes of data coming from the DXM local registers 1, 10, 20, and 21. The rest of the data in assembly instance 100 is zero.

## 10.5 Setting up Email and Text Messaging

The DXM Wireless Controller can be configured to send email or SMS messages based on threshold conditions. Internal log files may be sent using email

Cellular-connected systems can use email or SMS. Ethernet-connected systems may only use email, but can send email to cellular phones as a SMS message depending upon the network carrier. To send email to a Verizon phone, use the phone number followed by @vttext.com, for example, 1234567890@vttext.com.

Following these instructions using the DXM Configuration Tool to program the controller for email and/or SMS.

1. Set the time on the DXM Wireless Controller.
2. Define the Network I nterface settings by selecting either Ethernet or Cell on the Cloud Services screen.
3. If you selected Ethernet, configure your Ethernet connection by setting the IP settings on the Network screen.
4. Set the email and message parameters on the Mail and Messaging screen.
5. To send alert messages, define the threshold rule to use email and/or SMS.
6. To send log files, define the log file parameters.

<sup>7</sup> EttherNet/IP is a trademark of Rockwell Automation.

## 10.5.1 Define the Network Interface Settings

On the Cloud Services screen, define the network connection settings by selecting Ethernet or Cell from the Network Interface drop-down list. This determines how the DXM Wireless Controller sends data.

When selecting Ethernet, provide the network parameters on the Network screen. If you don't require pushing data to a web server, set the Cloud Push interval to zero.

The screenshot displays the 'Cloud Services' configuration page in the DXM Configuration Tool. The interface is organized into several sections:

- Navigation:** A vertical sidebar on the left contains 'Local Registers', 'Register Mapping', 'Action Rules', 'Scheduler', 'Register View', and 'Settings' (highlighted in yellow).
- Tabs:** A horizontal row of tabs at the top includes 'General', 'Cloud Services' (selected), 'Logging', 'Scripting', 'Network', 'Mail and Messaging', 'Administration', and 'Notes'.
- Network Interface:** A dropdown menu is set to 'Ethernet'. Below it, the 'Cell configuration' section shows 'Cell module' as 'CE910' and an unchecked 'Enable Server Mode' checkbox. Fields for 'APN', 'APN Username', and 'APN Password' are present.
- Cloud Push:** This section contains three time-based intervals: 'Cloud push interval' (00:15:00), 'Logging interval' (00:00:00), and 'Push port' (80). Each interval has a small up/down arrow icon.
- Webservice:** Fields include 'Server name/IP' (demopush.sensonix.net), 'Page' (/push.aspx), 'Host header', and 'Site ID' (b3ce7448-b38b-4ea7-b994-17162a779eac) with a 'Clear' button.
- HTTPS:** A checkbox for 'Use HTTPS' is unchecked, and the 'Certificate CN' field contains \*.sensonix.net.
- Webservice Authentication:** A 'Require Authentication' checkbox is unchecked, with fields for 'Username' and 'Password', and a 'Send Authentication' button.

## 10.5.2 Configure your Ethernet Connection

To send email based on a threshold rule or to email log files, first define the network and email servers. In the DXM Configuration Tool, go to Settings > Network.

1. To define the Ethernet IP address, give the DXM Wireless Controller a static IP address. In most cases you may select the device to use DHCP and have the IP address automatically assigned.
2. DNS settings are not typically required. The DXM Wireless Controller uses a public service to resolve Domain names, but if the network connection does not have Internet access, the DNS settings may be required.

The screenshot displays the 'Network' configuration page of the Sure Cross DXM150-Bx Wireless Controller. The interface includes a sidebar with navigation options: Local Registers, Register Mapping, Action Rules, Scheduler, Register View, and Settings (highlighted). The main content area is divided into several sections:

- Current Device IP:** IP Address (0.0.0.0), Subnet (0.0.0.0), Gateway address (0.0.0.0). Includes a 'Get Settings from Device' button.
- Cell Firewall:** Cell firewall IP address (0.0.0.0), Cell firewall Netmask (255.255.255.0).
- IP Address:** Static IP dropdown, IP address (0.0.0.0), Subnet (255.255.255.0), Gateway address (0.0.0.0).
- DNS:** Primary DNS IP address (0.0.0.0), Secondary DNS IP address (0.0.0.0), Primary cell DNS IP address (0.0.0.0), Secondary cell DNS IP address (0.0.0.0).
- Network Parameters:**
  - Ethernet:** Retry (0), Retry wait (00:00:00.000).
  - Cellular:** Retry (0), Retry wait (00:00:00.000), Activity timeout (00:00:00), Watchdog timeout (00:00:00.000).
- Cell Software Firewall:**
  - Open software firewall
  - \*If there are no valid entries for a section, the firewall is left open for that category of messages.
  - Phone Number: [ ] Add Remove
  - Open to all SMSs
  - IP Address: [ ] Add Remove
  - Open to all IPs
  - Email Address: [ ] Add Remove
  - Open to all Emails

### 10.5.3 Configure your Cellular Connection

A cellular connection does not require any configuration other than being selected as the network connection under the Cloud Services screen.

### 10.5.4 Set the Email and Messaging Parameters

From the Settings > Mail and Messaging screen, enter the SMTP definition, login, and password for a mail server. You must supply the SMTP Server, Server Port, and login credentials to send email. When only sending SMS messages over cellular, the SMTP Server is not required. The default SMTP port is 25 but may need to be adjusted for Ethernet-based networks. Note that many facilities block port 25. Port 587 is another common SMTP submission port.

The SMTP password is not stored in the XML configuration file, but on the DXM Wireless Controller. After the password is entered, click on Send SMTP Password to send it to the DXM Wireless Controller. The password is stored in non-volatile memory, so reboot the DXM Wireless Controller to recognize the new password.

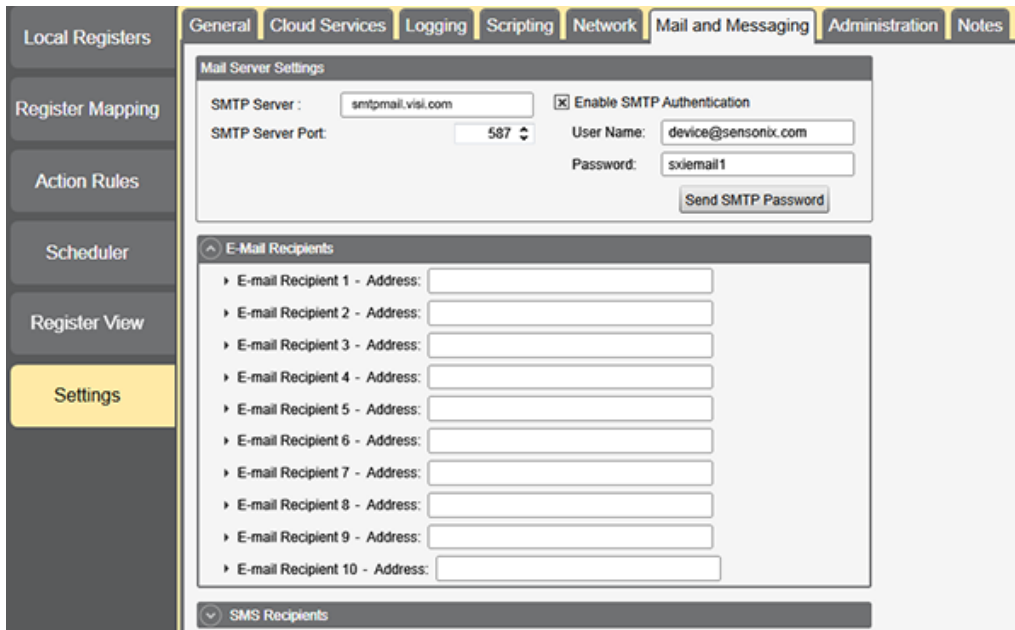

At the bottom of the screen, define the recipient to receive emails and enter the phone numbers for SMS messages. These recipients for email or SMS messages can be selected in the threshold definition for sending alert messages.

### 10.5.5 Define Threshold Rules for Email

To define a threshold, go to Action Rules > Thresholds. Depending upon which recipients are defined, select the appropriate email or SMS checkbox for the threshold rule (under Email/SMS on state transition). When the threshold rules goes active or inactive, an email is generated.

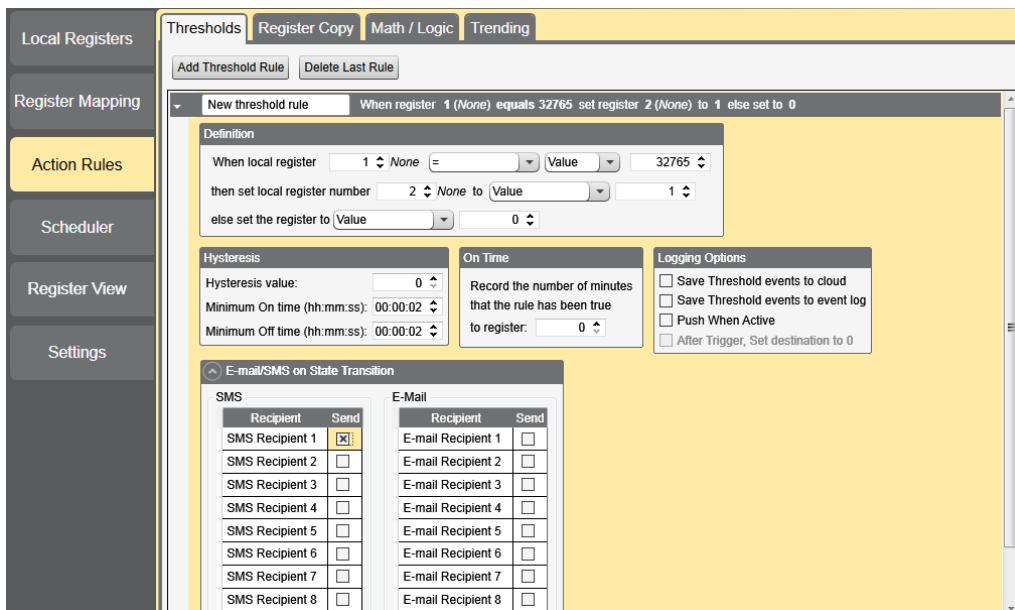

### 10.5.6 Define Log File Parameters for Emailing Log Files

The DXM Wireless Controller can email log files generated on the device.

Before emailing log files, set the Mail and Messaging parameters to provide the login credentials. When using Ethernet, verify the IP address settings are defined on the Network screen. Set the DXM Wireless Controller time, under Settings > General, so that all data is properly time stamped.



Select the registers to log on the Local Registers > Register Configuration screen. Define the setup of the log file using the Settings > Logging screen. Typical settings are shown.

1. Enable the log and timestamp with every entry.
2. Enter the filename, log rate, and the maximum file size to send via email (5 to 10k is an efficient size for a cellular connection).
3. Define the email address.

4. Define the local register data put into the log file using the Local Registers > Local Register Configuration screen, under the Logging and Protocol Conversion section. From the SD Card Logging drop-down list, select the log file to write to. Log files are written in CSV format.
5. Use the DXM Configuration Tool to read back the log files. Under Settings > Logging, click Refresh List, highlight the file to download, then click Save Selected.

## 10.6 Ethernet and Cellular Push Retries

The DXM Wireless Controller can be configured to send register data packets to a webserver. When the Ethernet or cell communications path is not operating, the DXM Wireless Controller retries the send procedure. The communications retry process is outlined below for each configuration.

Regardless of the communications connection (Ethernet or cellular), a failed attempt results in the register data packet being saved on the local micro SD card<sup>8</sup>. The number of retries will depend upon the network connection type.

When there is bad cellular signal strength or there is no Ethernet connection, the transmission attempts are not counted as failed attempts to send data. Only when there is a good network connection and there are 10 failed attempts will the controller archive the data on the SD card. Data archived on the SD card must be manually retrieved.

### 10.6.1 Ethernet Push Retries

With an Ethernet-based network connection, the DXM Wireless Controller retries a message five times. The five retry attempts immediately follow each other. After all attempts are exhausted, the register data packet is saved on the micro SD card.

At the next scheduled time, the DXM Wireless Controller attempts to send the saved packet as well as the newly created register data packet. If it cannot send the new register data packet, the new register data packet is appended to the saved file on the micro SD card to be sent later. After 10 rounds of retries, the data set is archived on the micro SD card under folder `_sxi`. No additional attempts to resend the data are made; the data file must be manually retrieved.

Using SSL on Ethernet will have no retries, but will save each failed attempt to the micro SD card until 10 failed rounds. At this time, the register data packet is archived.

### 10.6.2 Cellular Push Retries

In a cellular-connected system there are no retries. Failed transmissions are saved on the micro SD card.

After 10 successive failed attempts, the data is archived in the `_sxi` folder. Send attempts with a low signal quality are not counted against the 10 count limit. For example, if the cellular antenna is disconnected for period that the DXM controller would have sent 20 messages under normal circumstances, all 20 messages would be saved and will be retried when the antenna is reconnected. If the signal quality was good, but the cellular network was not responding, the DXM Wireless Controller archives the register data packets after 10 failed attempts.

<sup>8</sup> Enable HTTP logging to save data on the SD card; this is the factory default. See SETTINGS -> LOGGING in the DXM Configuration Tool.

### 10.6.3 Event/Action Rule or Log File Push Retries

Event-based pushes caused by Action rules and locally stored log files sent using email follow the same process when failures occur, based on the network connection. The failed Event-based messages are resent with the next cyclical schedule or the next event message that triggers a push message.

### 10.6.4 Email and Text Message Push Retries

There are no retries for emails or SMS messages that fail to be sent from the DXM Wireless Controller.

## 10.7 DXM Modbus Registers

The DXM150-Bx Wireless Controller may have up to four internal Modbus slave devices:

DXM Internal Modbus Slave IDs (factory default)	
Modbus Slave ID	Device
1	Gateway (PE5) or MultiHop (HE5) ISM Radio—MultiHop wireless devices connected to the internal MultiHop radio should be assigned Modbus Slave addresses starting at 11.
199	Local Registers—Internal storage registers of the DXM Wireless Controller
200	I/O Base Board—All data and parameters for each input or output of the DXM Wireless Controller.
201	LCD Display—The user has access to the LED indicators on the DXM Wireless Controller.

All Modbus registers are defined as 16-bit Modbus Holding Registers. When connecting external Modbus slave devices, only use Modbus slave IDs 2 through 198. The local registers, the I/O base, and the LCD slave IDs are fixed, but the internal radio slave ID can be changed if needed.

## 11 File System and Archive Process

The DXM file system consists of two physical components: the serial EEPROM that stores non-volatile configuration information and a removable micro SD card that stores file backup data and user created files.

### 11.1 EEPROM Files

The serial EEPROM stores basic data that is required to be non-volatile, including network configuration data, IP address, MAC address, network masks, firewall settings, and authentication information. The controller XML configuration file created by the DXM Configuration Tool is stored in EEPROM. The small section of non-volatile local registers is also stored in EEPROM.

### 11.2 Micro SD Card Files

The micro SD card contains most files at the root level. The archive directory contains files kept by the system for history backup. Archive files are stored in the directory `_sxi` and are only accessible by removing the SD card.

- Data Log Files
- HTTP Push Files
- User created ScriptBasic file
- ScriptBasic program file
- CmVMon file
- `_sxi` Archive directory

#### Archive Directory

Only two types of files are moved into the archive directory: data log files and HTTP log files. Data log files are date/time stamped and placed into the archive directory when the size limit is reached. HTTP log files are date/time stamped then placed into the archive directory when they are successfully sent to the webserver or host system. If the HTTP log files were not successfully sent after the retries have been exhausted, the files are placed into a root directory called `sav`.

#### Data Log files

Users may create up to four data log files using the DXM Configuration Tool. The log files are stored in the root directory on the SD card. When the file size limit is reached, the filename is changed to include the date and time and the file is moved into the archive directory `_sxi`. If a finished log file is to be e-mailed, it will be done at this time and then moved into the archive directory. Archived log files are deleted based on the Clear Logs parameter.

#### HTTP Push File

If the DXM Wireless Controller is configured to send data to a webserver or host system, the device creates an HTTP.LOG file on the SD card. The HTTP log is created only if the Logging Interval is non-zero and the HTTP enable log is set. An entry is placed in the HTTP log file at the Logging Interval specified by the user. At the Push Interval time, the HTTP log file is sent to the webserver or host system. If the transmission is successful, the HTTP log file is time stamped and placed into the archive directory (`_sxi`). If the transmission fails, the file remains in the root directory and subsequent Logging Intervals are appended to the file and are sent at the next Push Interval. For more information on the communications retry mechanism, refer to the technical note on system retries. (*DXM Ethernet and Cellular Push Retries.docx*).

#### ScriptBasic Created Files

Users may use ScriptBasic to create files on the SD card by using the FILEOUT function. The filenames are fixed and up to five files can be created in the root directory.

#### ScriptBasic Program File

The main ScriptBasic program that runs at boot time is stored on the SD card in the root directory.

#### System Voltage Monitor File

The CmVMon.txt file (Cellular milli-Volt Monitor) is created by the system and is used to track power events. Every power-up cycle is date/time stamped with the voltage read from the I/O board. The value 24487 is equal to 24.487 volts. If the voltage drops below 11.2 V, another entry is put in the log file indicating the cellular modem will shut down.

CM	2015-09-22 18:52:43	VMon	Power entered normal range 24487
CM	2015-10-13 20:49:47	VMon	Power entered normal range 24004
CM	2015-10-16 15:00:20	VMon	Power entered normal range 24014
CM	2015-10-19 19:12:26	VMon	Power entered normal range 12845

## 12 DXM150 Dimensions

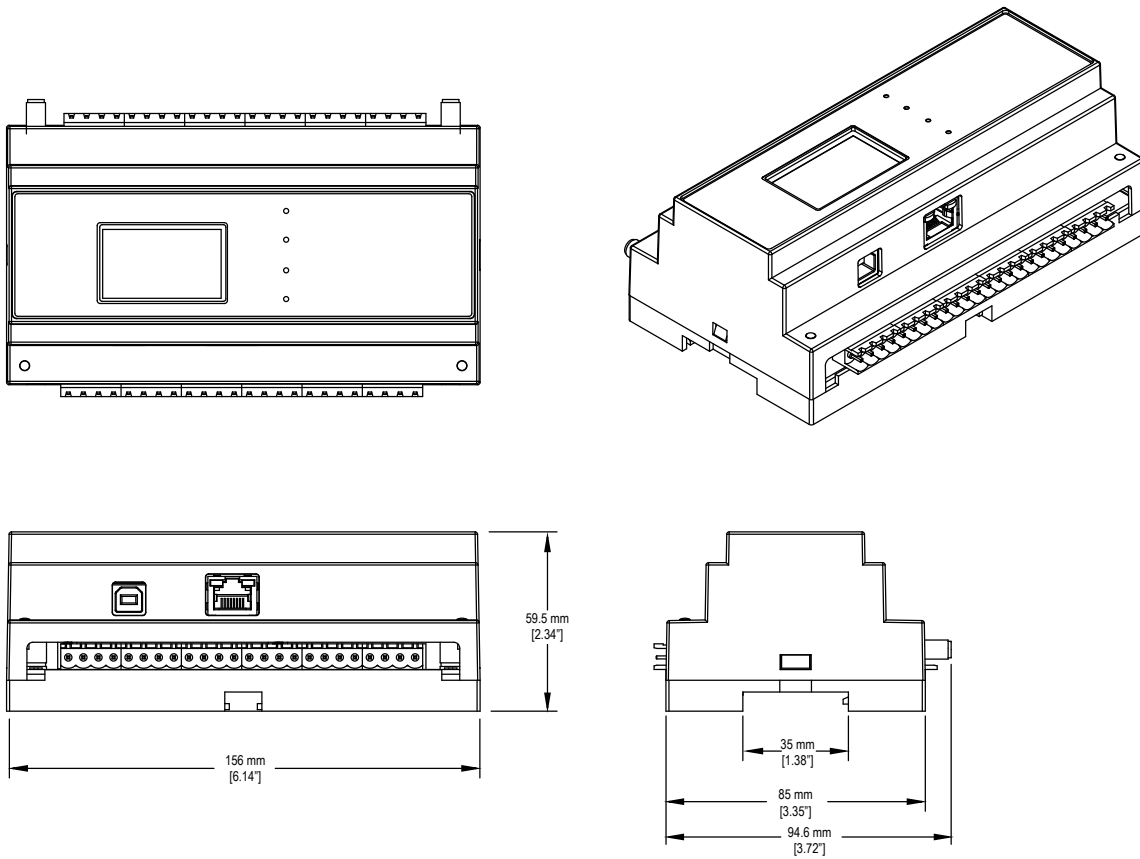

All measurements are listed in millimeters [inches], unless noted otherwise.

# 13 Contact Us

## Corporate Headquarters

Address:  
Banner Engineering Corporate  
9714 Tenth Avenue North  
Minneapolis, Minnesota 55441, USA

Phone: +1 763 544 3164  
Website: [www.bannerengineering.com](http://www.bannerengineering.com)

## Europe

Address:  
Banner Engineering EMEA  
Park Lane Culliganlaan 2F  
Diegem B-1831, Belgium

Phone: +32 (0)2 456 0780  
Website: [www.bannerengineering.com/eu](http://www.bannerengineering.com/eu)  
Email: [mail@bannerengineering.com](mailto:mail@bannerengineering.com)

## Turkey

Address:  
Banner Engineering Turkey  
Barbaros Mah. Uphill Court Towers A Blok D: 49  
34746 Batı Ataşehir İstanbul Türkiye

Phone: +90 216 688 8282  
Website: [www.bannerengineering.com.tr](http://www.bannerengineering.com.tr)  
Email: [turkey@bannerengineering.com.tr](mailto:turkey@bannerengineering.com.tr)

## India

Address:  
Banner Engineering India Pune Head Quarters  
Office No. 1001, 10th Floor Sai Capital, Opp. ICC Senapati Bapat Road  
Pune 411016, India

Phone: +91 (0) 206 640 5624  
Website: [www.bannerengineering.co.in](http://www.bannerengineering.co.in)  
Email: [salesindia@bannerengineering.com](mailto:salesindia@bannerengineering.com)

## Mexico

Address:  
Banner Engineering de Mexico Monterrey Head Office  
Edificio VAO Av. David Alfaro Siqueiros No.103 Col. Valle Oriente C.P.66269  
San Pedro Garza Garcia, Nuevo Leon, Mexico

Phone: +52 81 8363 2714 or 01 800 BANNERE (toll free)  
Website: [www.bannerengineering.com.mx](http://www.bannerengineering.com.mx)  
Email: [mexico@bannerengineering.com](mailto:mexico@bannerengineering.com)

## Brazil

Address:  
Banner do Brasil  
Rua Barão de Teffé nº 1000, sala 54  
Campos Eliseos, Jundiaí - SP, CEP.: 13208-761, Brasil

Phone: +1 763 544 3164  
Website: [www.bannerengineering.com.br](http://www.bannerengineering.com.br)  
Email: [brasil@bannerengineering.com](mailto:brasil@bannerengineering.com)

## China

Address:  
Banner Engineering Shanghai Rep Office  
Xinlian Scientific Research Building Level 12, Building 2  
1535 Hongmei Road, Shanghai 200233, China

Phone: +86 212 422 6888  
Website: [www.bannerengineering.com.cn](http://www.bannerengineering.com.cn)  
Email: [sensors@bannerengineering.com.cn](mailto:sensors@bannerengineering.com.cn)

## Japan

Address:  
Banner Engineering Japan  
Cent-Urban Building 305 3-23-15 Nishi-Nakajima Yodogawa-Ku  
Osaka 532-0011, Japan

Phone: +81 (0)6 6309 0411  
Website: [www.bannerengineering.co.jp](http://www.bannerengineering.co.jp)  
Email: [mail@bannerengineering.co.jp](mailto:mail@bannerengineering.co.jp)

## Taiwan

Address:  
Banner Engineering Taiwan  
8F-2, No. 308 Section 1, Neihu Road  
Taipei 114, Taiwan

Phone: +886 (0)2 8751 9966  
Website: [www.bannerengineering.com.tw](http://www.bannerengineering.com.tw)  
Email: [info@bannerengineering.com.tw](mailto:info@bannerengineering.com.tw)

## 14 Warnings

Install and properly ground a qualified surge suppressor when installing a remote antenna system. Remote antenna configurations installed without surge suppressors invalidate the manufacturer's warranty. Keep the ground wire as short as possible and make all ground connections to a single-point ground system to ensure no ground loops are created. No surge suppressor can absorb all lightning strikes; do not touch the Sure Cross® device or any equipment connected to the Sure Cross device during a thunderstorm.

Exporting Sure Cross® Radios. It is our intent to fully comply with all national and regional regulations regarding radio frequency emissions. Customers who want to re-export this product to a country other than that to which it was sold must ensure the device is approved in the destination country. A list of approved countries appears in the *Radio Certifications* section of the product manual. The Sure Cross wireless products were certified for use in these countries using the antenna that ships with the product. When using other antennas, verify you are not exceeding the transmit power levels allowed by local governing agencies. Consult with Banner Engineering Corp. if the destination country is not on this list.

### 14.1 Banner Engineering Corp. Limited Warranty

---

Banner Engineering Corp. warrants its products to be free from defects in material and workmanship for one year following the date of shipment. Banner Engineering Corp. will repair or replace, free of charge, any product of its manufacture which, at the time it is returned to the factory, is found to have been defective during the warranty period. This warranty does not cover damage or liability for misuse, abuse, or the improper application or installation of the Banner product.

THIS LIMITED WARRANTY IS EXCLUSIVE AND IN LIEU OF ALL OTHER WARRANTIES WHETHER EXPRESS OR IMPLIED (INCLUDING, WITHOUT LIMITATION, ANY WARRANTY OF MERCHANTABILITY OR FITNESS FOR A PARTICULAR PURPOSE), AND WHETHER ARISING UNDER COURSE OF PERFORMANCE, COURSE OF DEALING OR TRADE USAGE.

This Warranty is exclusive and limited to repair or, at the discretion of Banner Engineering Corp., replacement. IN NO EVENT SHALL BANNER ENGINEERING CORP. BE LIABLE TO BUYER OR ANY OTHER PERSON OR ENTITY FOR ANY EXTRA COSTS, EXPENSES, LOSSES, LOSS OF PROFITS, OR ANY INCIDENTAL, CONSEQUENTIAL OR SPECIAL DAMAGES RESULTING FROM ANY PRODUCT DEFECT OR FROM THE USE OR INABILITY TO USE THE PRODUCT, WHETHER ARISING IN CONTRACT OR WARRANTY, STATUTE, TORT, STRICT LIABILITY, NEGLIGENCE, OR OTHERWISE.

Banner Engineering Corp. reserves the right to change, modify or improve the design of the product without assuming any obligations or liabilities relating to any product previously manufactured by Banner Engineering Corp. Any misuse, abuse, or improper application or installation of this product or use of the product for personal protection applications when the product is identified as not intended for such purposes will void the product warranty. Any modifications to this product without prior express approval by Banner Engineering Corp will void the product warranties. All specifications published in this document are subject to change; Banner reserves the right to modify product specifications or update documentation at any time. Specifications and product information in English supersede that which is provided in any other language. For the most recent version of any documentation, refer to: [www.bannerengineering.com](http://www.bannerengineering.com).