

Datasheet

Medium Sized, Multicolor Indicator with Audible Models

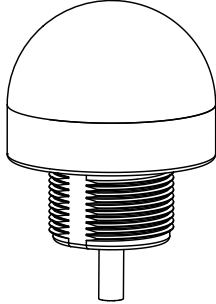

- Bright, uniform indicator light
- IO-Link control allows access to full color, flashing and dimming controls as well as advanced animations
- Millions of color possibilities
- 30 mm threaded polycarbonate base
- Translucent polycarbonate dome
- Rugged IP66, IP67, and IP69K design
- Models with integrated audible alarm available
- Models constructed from FDA-grade materials available

Models

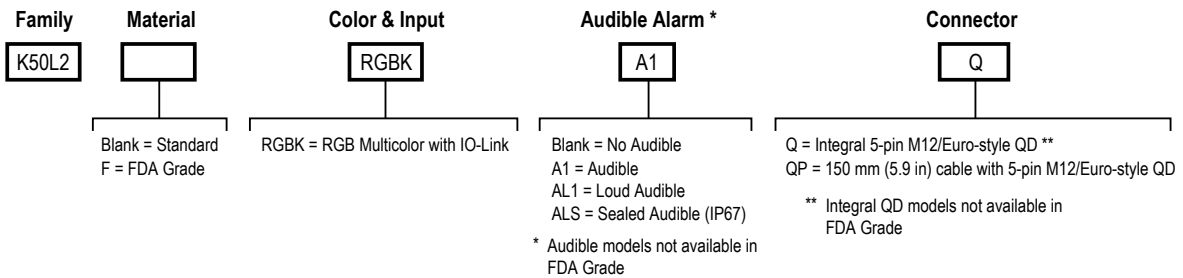

Wiring Diagram

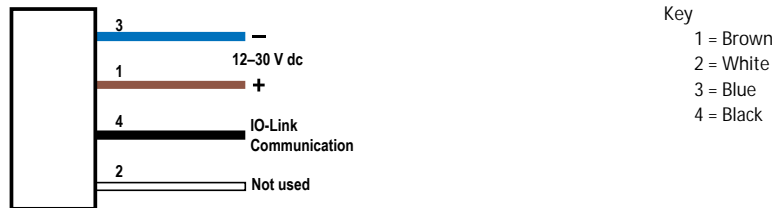

IO-Link Process Out Data

IO-Link is a point-to-point communication link between a master device and a sensor and/or light. It can be used to automatically parameterize sensors or lights and to transmit and/or receive process data. For the latest IO-Link protocol and specifications, please visit www.io-link.com. For the latest IODD files, please refer to the Banner Engineering Corp website at: www.bannerengineering.com.

Process Data is transmitted cyclically to the IO-Link® device from the IO-Link master. These parameters are written to the K50 acyclically and are used to perform the following functions:

- Indicator light on and off
- Audible on and off (audible models only)
- Full color control of indicator light (defined colors and ability to create custom colors)
- Full flashing control of indicator light (defined flashing rates and ability to create custom rates)
- Full dimming control of indicator light (defined intensities and ability to create custom intensities)
- Various animation control and configurability
 - Flashing: flash light at defined flash rate (50/50 duty cycle)
 - Two-Color Flashing: flash two colors at defined flash rate, alternating (50/50 duty cycle)
 - Strobe: strobe light at defined flash rate (80/20 duty cycle)
 - Half/Half: show half one color and half another color



- Half/Half Rotate: animation that shows half one color and half another color while rotating clockwise or counter-clockwise
- Chase: animation that shows a single spot in one color against a background of another color while rotating clockwise or counter-clockwise
- Demo Mode: cycles through defined colors and then through color spectrum



Note: More color shades can be made by adjusting intensity

IO-Link Process Data Out for the K50	
Name	Values
Color 1	Green, Red, Orange, Yellow, Lime Green, Spring Green, Cyan, Sky Blue, Blue, Violet, Magenta, Rose, White, 5 Custom Colors to define
Color 2	
Color Flash Rate (Hz)	0.5, 1.5, 3, 6, 9, 12, Custom Rate to define
Color 1 Intensity	High, Medium, Low, Custom Intensity to define
Color 2 Intensity	
Audible Mode	Off, On, Pulsed
Animation Mode	Steady, Flash, Two-Color Flash, Strobe, Half/Half, Half/Half Rotate, Chase, Demo Mode
Rotation Direction	Counter Clockwise, Clockwise

For more information see IO-Link Data Reference Guide: K50L2 Multicolor RGB Indicator (p/n 200721).

Specifications

Supply Voltage and Current

24V dc \pm 25%
115 mA typical at 24V dc
150 mA max at 18V dc

Supply Protection Circuitry

Protected against reverse polarity and transient voltages

Indicator Characteristics

Color	Dominant Wavelength (nm) or Color Temperature (CCT)	Color Coordinates ¹		Lumen Output (Typical at 25 °C)
		x	y	
Red	625 nm	0.687	0.308	5.5
Orange	–	0.612	0.372	8.1
Yellow	–	0.493	0.471	14.6
Lime Green	–	0.387	0.561	25.9
Green	530 nm	0.197	0.720	20.9
Spring Green	–	0.180	0.529	22.0
Cyan	–	0.164	0.350	24.0
Sky Blue	–	0.155	0.250	22.8
Blue	470 nm	0.140	0.076	5.1
Violet	–	0.213	0.107	8.1
Magenta	–	0.382	0.179	7.3
Rose	–	0.507	0.231	6.2
White	5700 K	0.328	0.337	20.0

Construction

Standard model base, dome, and nut: polycarbonate
FDA model base, dome, and nut: FDA grade polycarbonate

Connections

Integral 4-pin M12/Euro-style quick disconnect, or 150 mm (6 in) PVC cable with quick disconnect, depending on model

Mounting

M30 by 1.5 threaded base Max. Torque 4.5 Mn (40 in-ibf) (mounting nut included)

Vibration and Mechanical Shock

All models meet Mil. Std. 202F requirements. Method 201A (Vibration; frequency 10 Hz to 60 Hz, max., double amplitude 0.06 inch acceleration 10G). Also meets IEC 60947-5-1 requirements: 15G 11 ms duration, half sine wave.

Input Response Time

30 ms maximum while active

Audible Alarm

All models have a Steady tone
A1 Model: 75 dB at 1 m (typical), 3 kHz \pm 500 Hz
AL1 Model: 95 dB at 1 m (typical), 2.7 kHz \pm 500 Hz
ALS Model: 94 dB at 1 m (typical), 2.9 kHz \pm 250 Hz

Required Overcurrent Protection



WARNING: Electrical connections must be made by qualified personnel in accordance with local and national electrical codes and regulations.

Overcurrent protection is required to be provided by end product application per the supplied table.

Overcurrent protection may be provided with external fusing or via Current Limiting, Class 2 Power Supply.

Supply wiring leads < 24 AWG shall not be spliced.

For additional product support, go to www.bannerengineering.com.

Supply Wiring (AWG)	Required Overcurrent Protection (Amps)
20	5.0
22	3.0
24	2.0
26	1.0
28	0.8
30	0.5

Operating Conditions

–40 °C to +50 °C (–40 °F to +122 °F)
90% at +50 °C maximum relative humidity (non-condensing)
Storage Temperature: –40 °C to +70 °C (–40 °F to +158 °F)

Environmental Rating

Non-Audible Models: IEC IP66, IEC IP67, IEC IP69K per DIN 40050-9

A1 and AL1 Models: IEC IP50

ALS Models: IEC IP66, IEC IP67, IEC IP69K

Certifications

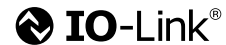

¹ Refer to CIE 1931 chromaticity diagram or color chart, to show equivalent color with indicated color coordinates.

Dimensions

A1 and AL1 Audible Models

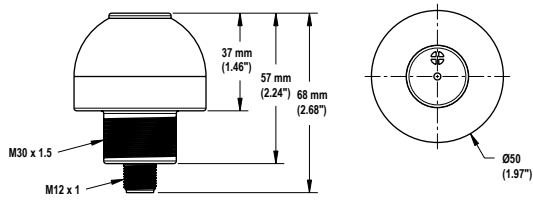

ALS Audible Model

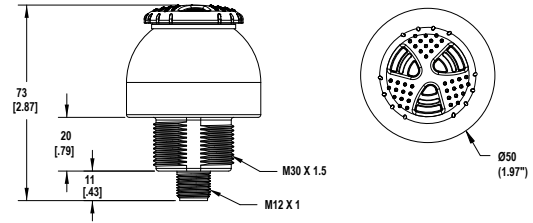

Non-Audible Model

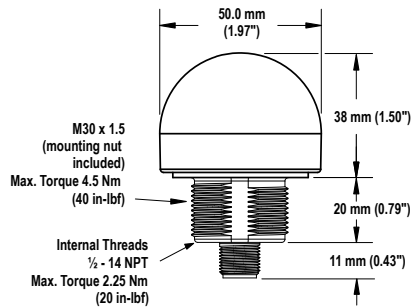

Accessories

Cordsets

4-Pin Threaded M12/Euro-Style Cordsets—Double Ended				
Model	Length	Style	Dimensions	Pinout
MODEC-401SS	0.31 m (1 ft)	Male Straight/Female Straight		Female
MODEC-403SS	0.91 m (3 ft)			
MODEC-406SS	1.83 m (6 ft)			Male
MODEC-412SS	3.66 m (12 ft)			
MODEC-420SS	6.10 m (20 ft)			
MODEC-430SS	9.14 m (30 ft)			
MODEC-450SS	15.2 m (50 ft)			

Brackets

SMB30A

- Right-angle bracket with curved slot for versatile orientation
- Clearance for M6 (¼ in) hardware
- Mounting hole for 30 mm sensor
- 12-ga. stainless steel

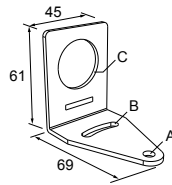

Hole center spacing: A to B=40
Hole size: A=ø 6.3, B= 27.1 x 6.3, C=ø 30.5

SMB30FVK

- V-clamp, flat bracket and fasteners for mounting to pipe or extensions
- Clamp accommodates 28 mm dia. tubing or 1 in. square extrusions
- 30 mm hole for mounting sensors

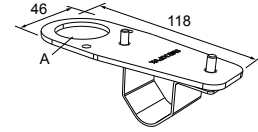

Hole size: A= ø 31

SMB30RAVK

- V-clamp, right-angle bracket and fasteners for mounting sensors to pipe or extrusion
- Clamp accommodates 28 mm dia. tubing or 1 in. square extrusions
- 30 mm hole for mounting sensors

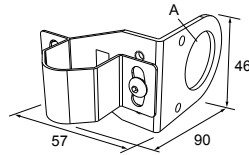

Hole size: A = ø 30.5

SMBAMS30P

- Flat SMBAMS series bracket
- 30 mm hole for mounting sensors
- Articulation slots for 90°+ rotation
- 12-ga. 300 series stainless steel

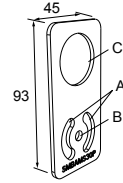

Hole center spacing: A=26.0, A to B=13.0
Hole size: A=26.8 x 7.0, B=ø 6.5, C=ø 31.0

SMBAMS30RA

- Right-angle SMBAMS series bracket
- 30 mm hole for mounting sensors
- Articulation slots for 90°+ rotation
- 12-ga. (2.6 mm) cold-rolled steel

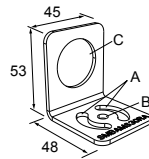

Hole center spacing: A=26.0, A to B=13.0
Hole size: A=26.8 x 7.0, B=ø 6.5, C=ø 31.0

SMB30MM

- 12-ga. stainless steel bracket with curved mounting slots for versatile orientation
- Clearance for M6 (¼ in) hardware
- Mounting hole for 30 mm sensor

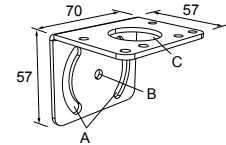

Hole center spacing: A = 51, A to B = 25.4
Hole size: A = 42.6 x 7, B = ø 6.4, C = ø 30.1

SMB30SC

- Swivel bracket with 30 mm mounting hole for sensor
- Black reinforced thermoplastic polyester
- Stainless steel mounting and swivel locking hardware included

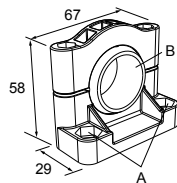

Hole center spacing: A=ø 50.8
Hole size: A=ø 7.0, B=ø 30.0

SMB30FA

- Swivel bracket with tilt and pan movement for precise adjustment
- Mounting hole for 30 mm sensor
- 12-ga. 304 stainless steel
- Easy sensor mounting to extrude rail T-slot
- Metric and inch size bolt available

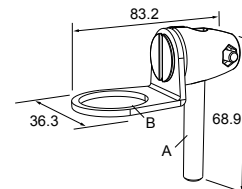

Bolt thread: SMB30FA, A= 3/8 - 16 x 2 in; SMB30FAM10, A= M10 - 1.5 x 50
Hole size: B= ø 30.1

Banner Engineering Corp. Limited Warranty

Banner Engineering Corp. warrants its products to be free from defects in material and workmanship for one year following the date of shipment. Banner Engineering Corp. will repair or replace, free of charge, any product of its manufacture which, at the time it is returned to the factory, is found to have been defective during the warranty period. This warranty does not cover damage or liability for misuse, abuse, or the improper application or installation of the Banner product.

THIS LIMITED WARRANTY IS EXCLUSIVE AND IN LIEU OF ALL OTHER WARRANTIES WHETHER EXPRESS OR IMPLIED (INCLUDING, WITHOUT LIMITATION, ANY WARRANTY OF MERCHANTABILITY OR FITNESS FOR A PARTICULAR PURPOSE), AND WHETHER ARISING UNDER COURSE OF PERFORMANCE, COURSE OF DEALING OR TRADE USAGE.

This Warranty is exclusive and limited to repair or, at the discretion of Banner Engineering Corp., replacement. IN NO EVENT SHALL BANNER ENGINEERING CORP. BE LIABLE TO BUYER OR ANY OTHER PERSON OR ENTITY FOR ANY EXTRA COSTS, EXPENSES, LOSSES, LOSS OF PROFITS, OR ANY INCIDENTAL, CONSEQUENTIAL OR SPECIAL DAMAGES RESULTING FROM ANY PRODUCT DEFECT OR FROM THE USE OR INABILITY TO USE THE PRODUCT, WHETHER ARISING IN CONTRACT OR WARRANTY, STATUTE, TORT, STRICT LIABILITY, NEGLIGENCE, OR OTHERWISE.

Banner Engineering Corp. reserves the right to change, modify or improve the design of the product without assuming any obligations or liabilities relating to any product previously manufactured by Banner Engineering Corp. Any misuse, abuse, or improper application or installation of this product or use of the product for personal protection applications when the product is identified as not intended for such purposes will void the product warranty. Any modifications to this product without prior express approval by Banner Engineering Corp will void the product warranties. All specifications published in this document are subject to change. Banner reserves the right to modify product specifications or update documentation at any time. Specifications and product information in English supersede that which is provided in any other language. For the most recent version of any documentation, refer to: www.bannerengineering.com.

FCC Part 15 and CAN ICES-3 (B)/NMB-3(B)

This device complies with part 15 of the FCC Rules and CAN ICES-3 (B)/NMB-3(B). Operation is subject to the following two conditions:

1. This device may not cause harmful interference, and
2. This device must accept any interference received, including interference that may cause undesired operation.

This equipment has been tested and found to comply with the limits for a Class B digital device, pursuant to part 15 of the FCC Rules and CAN ICES-3 (B)/NMB-3(B). These limits are designed to provide reasonable protection against harmful interference in a residential installation. This equipment generates, uses and can radiate radio frequency energy and, if not installed and used in accordance with the instructions, may cause harmful interference to radio communications. However, there is no guarantee that interference will not occur in a particular installation. If this equipment does cause harmful interference to radio or television reception, which can be determined by turning the equipment off and on, the user is encouraged to try to correct the interference by one or more of the following measures:

- Reorient or relocate the receiving antenna.
- Increase the separation between the equipment and receiver.
- Connect the equipment into an outlet on a circuit different from that to which the receiver is connected.
- Consult the manufacturer.