

# Guided Wave Radar

## SITRANS LG250

Profibus PA

Rod and cable probe

Operating Instructions • 01/2020



SITRANS

SIEMENS

**Safety Guidelines:** Warning notices must be observed to ensure personal safety as well as that of others, and to protect the product and the connected equipment. These warning notices are accompanied by a clarification of the level of caution to be observed.

**Qualified Personnel:** This device/system may only be set up and operated in conjunction with this manual. Qualified personnel are only authorized to install and operate this equipment in accordance with established safety practices and standards.

**Unit Repair and Excluded Liability:**

- The user is responsible for all changes and repairs made to the device by the user or the user's agent.
- All new components are to be provided by Siemens.
- Restrict repair to faulty components only.
- Do not reuse faulty components.

**Warning:** Cardboard shipping package provides limited humidity and moisture protection. This product can only function properly and safely if it is correctly transported, stored, installed, set up, operated, and maintained.

This product is intended for use in industrial areas. Operation of this equipment in a residential area may cause interference to several frequency based communications.

**Note:** Always use product in accordance with specifications.

<b>Copyright Siemens AG 2015. All Rights Reserved</b>	<b>Disclaimer of Liability</b>
This document is available in bound version and in electronic version. We encourage users to purchase authorized bound manuals, or to view electronic versions as designed and authored by Siemens. Siemens will not be responsible for the contents of partial or whole reproductions of either bound or electronic versions.	While we have verified the contents of this manual for agreement with the instrumentation described, variations remain possible. Thus we cannot guarantee full agreement. The contents of this manual are regularly reviewed and corrections are included in subsequent editions. We welcome all suggestions for improvement.  Technical data subject to change.

**Contact Siemens Technical Publications at the following address:**

Technical Publications  
Siemens Canada Limited  
PD PA PI LW  
1954 Technology Drive, P.O. Box 4225  
Peterborough, Ontario, Canada, K9J 7B1  
Email: [techpubs.smpi@siemens.com](mailto:techpubs.smpi@siemens.com)

**European Authorized Representative**

Siemens AG  
Industry Sector  
76181 Karlsruhe  
Deutschland

- For a selection of Siemens level measurement manuals, go to: **[www.siemens.com/processautomation](http://www.siemens.com/processautomation)**. Under Process Instrumentation, select *Level Measurement* and then go to the manual archive listed under the product family.
- For a selection of Siemens weighing manuals, go to: **[www.siemens.com/processautomation](http://www.siemens.com/processautomation)**. Under Weighing Technology, select *Continuous Weighing Systems* and then go to the manual archive listed under the product family.

---

# Contents

<b>1</b>	<b>About this document</b>	<b>5</b>
1.1	Function	5
1.2	Target group	5
1.3	Symbols used	5
<b>2</b>	<b>For your safety</b>	<b>6</b>
2.1	Authorised personnel	6
2.2	Appropriate use	6
2.3	Warning about incorrect use	6
2.4	General safety instructions	6
2.5	EU conformity	7
2.6	NAMUR recommendations	7
2.7	Installation and operation in the USA and Canada	7
<b>3</b>	<b>Product description</b>	<b>8</b>
3.1	Configuration	8
3.2	Principle of operation	9
3.3	Packaging, transport and storage	11
3.4	Accessories	12
<b>4</b>	<b>Mounting</b>	<b>13</b>
4.1	General instructions	13
4.2	Mounting instructions	14
<b>5</b>	<b>Connecting to power supply</b>	<b>22</b>
5.1	Preparing the connection	22
5.2	Connecting	23
5.3	Wiring plan, single chamber housing	24
5.4	Wiring plan, double chamber housing	24
5.5	Set instrument address	25
5.6	Switch-on phase	26
<b>6</b>	<b>Set up with the display and adjustment module</b>	<b>27</b>
6.1	Insert display and adjustment module	27
6.2	Adjustment system	28
6.3	Parameter adjustment - Quick setup	29
6.4	Parameter adjustment - Extended adjustment	29
6.5	Saving the parameterisation data	48
<b>7</b>	<b>Setup with PACTware</b>	<b>49</b>
7.1	Connect the PC	49
7.2	Parameter adjustment with PACTware	49
7.3	Set up with the quick setup	50
7.4	Saving the parameterisation data	52
<b>8</b>	<b>Set up with other systems</b>	<b>53</b>
8.1	DD adjustment programs	53
<b>9</b>	<b>Diagnostics and servicing</b>	<b>54</b>
9.1	Maintenance	54
9.2	Diagnosis memory	54
9.3	Status messages	55
9.4	Rectify faults	58

---

9.5	Exchanging the electronics module.....	63
9.6	Exchanging the cable/rod.....	63
9.7	Software update.....	65
9.8	How to proceed if a repair is necessary.....	66
<b>10</b>	<b>Dismount.....</b>	<b>67</b>
10.1	Dismounting steps.....	67
10.2	Disposal.....	67
<b>11</b>	<b>Supplement.....</b>	<b>68</b>
11.1	Technical data.....	68
11.2	Device communication Profibus PA.....	80
11.3	Dimensions.....	84
11.4	Trademark.....	89

**Safety instructions for Ex areas**



Take note of the Ex specific safety instructions for Ex applications. These instructions are attached as documents to each instrument with Ex approval and are part of the operating instructions.

Editing status: 2020-01-24

---

# 1 About this document

## 1.1 Function

This instruction provides all the information you need for mounting, connection and setup as well as important instructions for maintenance, fault rectification, the exchange of parts and the safety of the user. Please read this information before putting the instrument into operation and keep this manual accessible in the immediate vicinity of the device.

## 1.2 Target group

This operating instructions manual is directed to trained personnel. The contents of this manual must be made available to the qualified personnel and implemented.

## 1.3 Symbols used



**Information, note, tip:** This symbol indicates helpful additional information and tips for successful work.



**Note:** This symbol indicates notes to prevent failures, malfunctions, damage to devices or plants.



**Caution:** Non-observance of the information marked with this symbol may result in personal injury.



**Warning:** Non-observance of the information marked with this symbol may result in serious or fatal personal injury.



**Danger:** Non-observance of the information marked with this symbol results in serious or fatal personal injury.



### Ex applications

This symbol indicates special instructions for Ex applications.



### List

The dot set in front indicates a list with no implied sequence.



### Sequence of actions

Numbers set in front indicate successive steps in a procedure.



### Battery disposal

This symbol indicates special information about the disposal of batteries and accumulators.

---

## 2 For your safety

### 2.1 Authorised personnel

All operations described in this documentation must be carried out only by trained, qualified personnel authorised by the plant operator.

During work on and with the device, the required personal protective equipment must always be worn.

### 2.2 Appropriate use

SITRANS LG250 is a sensor for continuous level measurement.

You can find detailed information about the area of application in chapter "*Product description*".

Operational reliability is ensured only if the instrument is properly used according to the specifications in the operating instructions manual as well as possible supplementary instructions.

### 2.3 Warning about incorrect use

Inappropriate or incorrect use of this product can give rise to application-specific hazards, e.g. vessel overflow through incorrect mounting or adjustment. Damage to property and persons or environmental contamination can result. Also, the protective characteristics of the instrument can be impaired.

### 2.4 General safety instructions

This is a state-of-the-art instrument complying with all prevailing regulations and directives. The instrument must only be operated in a technically flawless and reliable condition. The operator is responsible for the trouble-free operation of the instrument. When measuring aggressive or corrosive media that can cause a dangerous situation if the instrument malfunctions, the operator has to implement suitable measures to make sure the instrument is functioning properly.

During the entire duration of use, the user is obliged to determine the compliance of the necessary occupational safety measures with the current valid rules and regulations and also take note of new regulations.

The safety instructions in this operating instructions manual, the national installation standards as well as the valid safety regulations and accident prevention rules must be observed by the user.

For safety and warranty reasons, any invasive work on the device beyond that described in the operating instructions manual may be carried out only by personnel authorised by the manufacturer. Arbitrary conversions or modifications are explicitly forbidden. For safety reasons, only the accessory specified by the manufacturer must be used.

To avoid any danger, the safety approval markings and safety tips on the device must also be observed.

---

## 2.5 EU conformity

The device fulfils the legal requirements of the applicable EU directives. By affixing the CE marking, we confirm the conformity of the instrument with these directives.

The EU conformity declaration can be found on our homepage.

### **Electromagnetic compatibility**

Instruments in four-wire or Ex-d-ia version are designed for use in an industrial environment. Nevertheless, electromagnetic interference from electrical conductors and radiated emissions must be taken into account, as is usual with class A instruments according to EN 61326-1. If the instrument is used in a different environment, the electromagnetic compatibility to other instruments must be ensured by suitable measures.

## 2.6 NAMUR recommendations

NAMUR is the automation technology user association in the process industry in Germany. The published NAMUR recommendations are accepted as the standard in field instrumentation.

The device fulfils the requirements of the following NAMUR recommendations:

- NE 21 – Electromagnetic compatibility of equipment
- NE 53 – Compatibility of field devices and display/adjustment components
- NE 107 – Self-monitoring and diagnosis of field devices

For further information see [www.namur.de](http://www.namur.de).

## 2.7 Installation and operation in the USA and Canada

This information is only valid for USA and Canada. Hence the following text is only available in the English language.

Installations in the US shall comply with the relevant requirements of the National Electrical Code (ANSI/NFPA 70).

Installations in Canada shall comply with the relevant requirements of the Canadian Electrical Code.

---

## 3 Product description

### 3.1 Configuration

#### Scope of delivery

The scope of delivery encompasses:

- Sensor SITRANS LG250
- Optional accessory

The further scope of delivery encompasses:

- Documentation
  - Operating instructions SITRANS LG250
  - Instructions for optional instrument features
  - Ex-specific "*Safety instructions*" (with Ex versions)
  - If necessary, further certificates



#### Information:

Optional instrument features are also described in this operating instructions manual. The respective scope of delivery results from the order specification.

#### Scope of this operating instructions

This operating instructions manual applies to the following instrument versions:

- Hardware from 1.0.0
- Software from 1.3.0
- Only for instrument versions without SIL qualification

#### Type label

The type label contains the most important data for identification and use of the instrument:



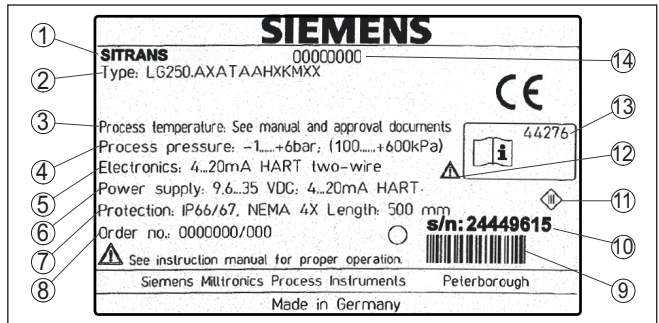

Fig. 1: Layout of the type label (example)

- 1 Instrument type
- 2 Product code
- 3 Process and ambient temperature
- 4 Process pressure
- 5 Signal output electronics
- 6 Voltage supply
- 7 Protection rating
- 8 Order number
- 9 Identification code
- 10 Serial number of the instrument
- 11 Symbol of the device protection class
- 12 Reminder to observe the instrument documentation
- 13 ID numbers, instrument documentation
- 14 Hardware and software version

## 3.2 Principle of operation

### Application area

The SITRANS LG250 is a level sensor with cable or rod probe for continuous level or interface measurement, suitable for applications in liquids.

### Functional principle - level measurement

High frequency microwave pulses are guided along a steel cable or a rod. Upon reaching the product surface, the microwave pulses are reflected. The running time is evaluated by the instrument and output as level.

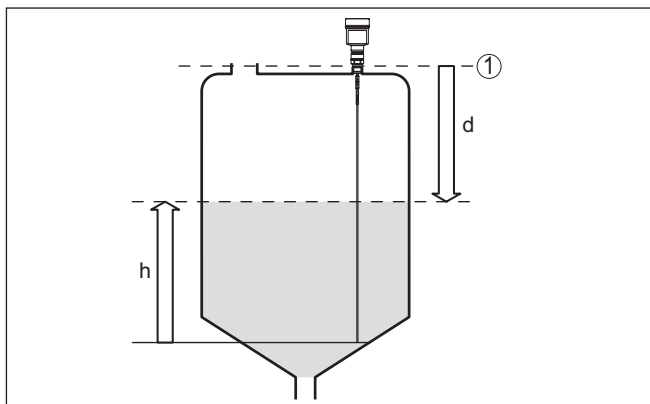

Fig. 2: Level measurement

- 1 Sensor reference plane (seal surface of the process fitting)
- d Distance to the level
- h Height - Level

### Functional principle - interface measurement

High frequency microwave impulses are guided along a steel cable or rod. Upon reaching the product surface, a part of the microwave impulses is reflected. The other part passes through the upper product and is reflected by the interface. The running times to the two product layers are processed by the instrument.

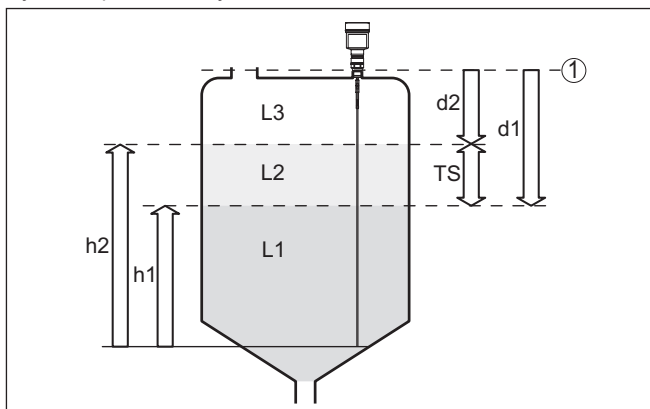

Fig. 3: Interface measurement

- 1 Sensor reference plane (seal surface of the process fitting)
- d1 Distance to the interface
- d2 Distance to the level
- TS Thickness of the upper medium ( $d1 - d2$ )
- h1 Height - Interface
- h2 Height - Level
- L1 Lower medium
- L2 Upper medium
- L3 Gas phase

---

**Prerequisites for interface measurement****Upper medium (L2)**

- The upper medium must not be conductive
- The dielectric constant of the upper medium or the actual distance to the interface must be known (input required). Min. dielectric constant: 1.6. You can find a list of dielectric constants on our home page: [www.siemens.com/sitranslg](http://www.siemens.com/sitranslg).
- The composition of the upper medium must be stable, no varying products or mixtures
- The upper medium must be homogeneous, no stratifications within the medium
- Min. thickness of the upper medium 50 mm (1.97 in)
- Clear separation from the lower medium, emulsion phase or detritus layer max. 50 mm (1.97 in)
- If possible, no foam on the surface

**Lower medium (L1)**

- The dielectric constant must be 10 higher than the dielectric constant of the upper medium, preferably electrically conductive. Example: upper medium dielectric constant 2, lower medium at least dielectric constant 12.

**Gas phase (L3)**

- Air or gas mixture
- Gas phase - dependent on the application, gas phase does not always exist ( $d_2 = 0$ )

**Output signal**

The instrument is always preset to the application "*Level measurement*".

For the interface measurement, you can select the requested output signal with the setup.

**Packaging**

### 3.3 Packaging, transport and storage

Your instrument was protected by packaging during transport. Its capacity to handle normal loads during transport is assured by a test based on ISO 4180.

The packaging consists of environment-friendly, recyclable cardboard. For special versions, PE foam or PE foil is also used. Dispose of the packaging material via specialised recycling companies.

**Transport**

Transport must be carried out in due consideration of the notes on the transport packaging. Nonobservance of these instructions can cause damage to the device.

**Transport inspection**

The delivery must be checked for completeness and possible transit damage immediately at receipt. Ascertained transit damage or concealed defects must be appropriately dealt with.

**Storage**

Up to the time of installation, the packages must be left closed and stored according to the orientation and storage markings on the outside.

---

Unless otherwise indicated, the packages must be stored only under the following conditions:

- Not in the open
  - Dry and dust free
  - Not exposed to corrosive media
  - Protected against solar radiation
  - Avoiding mechanical shock and vibration
- Storage and transport temperature see chapter "*Supplement - Technical data - Ambient conditions*"
- Relative humidity 20 ... 85 %

### **Storage and transport temperature**

### **Lifting and carrying**

With instrument weights of more than 18 kg (39.68 lbs) suitable and approved equipment must be used for lifting and carrying.

## **3.4 Accessories**

The instructions for the listed accessories can be found in the download area on our homepage.

### **Display and adjustment module**

The display and adjustment module LG Local Display Interface is used for measured value indication, adjustment and diagnosis.

### **External display and adjustment unit**

The LG Remote Interface is an external display and adjustment unit for sensors with single chamber housing and Ex d double chamber housing.

### **Flanges**

Screwed flanges are available in different versions according to the following standards: DIN 2501, EN 1092-1, BS 10, ASME B 16.5, JIS B 2210-1984, GOST 12821-80.

### **Rod components**

If you are using an instrument in rod version, you can extend the rod probe with curved segments and rod extensions of different lengths.

All extensions used must not exceed a total length of 6 m (19.7 ft).

The extensions are available in the following lengths:

#### **Rod ø 12 mm (0.472 in)**

- Basic segments: 20 ... 5900 mm (0.79 ... 232 in)
- Rod segments: 20 ... 5900 mm (0.79 ... 232 in)
- Curved segments: 100 x 100 mm (3.94 ... 3.94 in)

### **Centering**

If you mount the SITRANS LG250 in a bypass tube or standpipe, you have to avoid contact to the bypass tube by using a spacer at the probe end.

---

## 4 Mounting

### 4.1 General instructions

#### Screwing in

On devices with a threaded fitting, the hexagon on the process fitting must be tightened with a suitable wrench.

See chapter "*Dimensions*" for wrench size.

**Warning:**

The housing or the electrical connection may not be used for screwing in! Depending on the device version, tightening can cause damage, e. g. to the rotation mechanism of the housing.

#### Protection against moisture

Protect your instrument against moisture ingress through the following measures:

- Use a suitable connection cable (see chapter "*Connecting to power supply*")
- Tighten the cable gland or plug connector
- Lead the connection cable downward in front of the cable entry or plug connector

This applies mainly to outdoor installations, in areas where high humidity is expected (e.g. through cleaning processes) and on cooled or heated vessels.

**Note:**

Make sure that the degree of contamination specified in chapter "*Technical data*" meets the existing ambient conditions.

**Note:**

Make sure that during installation or maintenance no moisture or dirt can get inside the instrument.

To maintain the housing protection, make sure that the housing lid is closed during operation and locked, if necessary.

#### Cable glands

**Metric threads**

In the case of instrument housings with metric thread, the cable glands are screwed in at the factory. They are sealed with plastic plugs as transport protection.

You have to remove these plugs before electrical connection.

**NPT thread**

In the case of instrument housings with self-sealing NPT threads, it is not possible to have the cable entries screwed in at the factory. The free openings for the cable glands are therefore covered with red dust protection caps as transport protection. The dust protection caps do not provide sufficient protection against moisture.

Prior to setup you have to replace these protective caps with approved cable glands or close the openings with suitable blind plugs.

#### Process conditions

**Note:**

For safety reasons, the instrument must only be operated within the permissible process conditions. You can find detailed information on

the process conditions in chapter "*Technical data*" of the operating instructions or on the type label.

Hence make sure before mounting that all parts of the instrument exposed to the process are suitable for the existing process conditions.

These are mainly:

- Active measuring component
- Process fitting
- Process seal

Process conditions in particular are:

- Process pressure
- Process temperature
- Chemical properties of the medium
- Abrasion and mechanical influences

## 4.2 Mounting instructions

### Installation position

Mount SITRANS LG250 in such a way that the distance to vessel installations or to the vessel wall is at least 300 mm (12 in). In non-metallic vessels, the distance to the vessel wall should be at least 500 mm (19.7 in).

During operation, the probe must not touch any installations or the vessel wall. If necessary, fasten the probe end.

In vessels with conical bottom it can be advantageous to mount the sensor in the center of the vessel, as measurement is then possible nearly down to the lowest point of the bottom. Keep in mind that measurement all the way down to the tip of the probe may not be possible. The exact value of the min. distance (lower dead zone) is stated in chapter "*Technical data*" of the operating instructions.

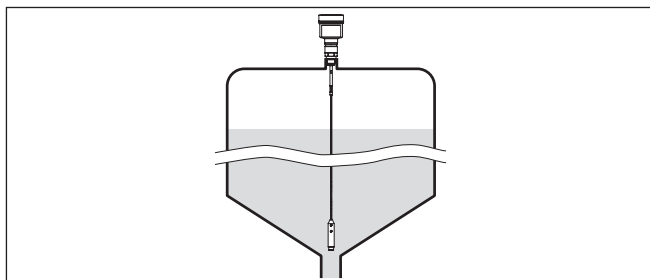

Fig. 4: Vessel with conical bottom

### Type of vessel

#### Plastic vessel/Glass vessel

The guided microwave principle requires a metallic surface on the process fitting. Therefore, in plastic vessels, etc., use an instrument version with flange (from DN 50) or place a metal sheet ( $\varnothing > 200$  mm/8 in) beneath the process fitting when screwing it in.

Make sure that the plate has direct contact with the process fitting.

When mounting rod or cable probes in vessels without metal walls, e.g. in plastic vessels, the measured value can be influenced by

strong electromagnetic fields (emitted interference according to EN 61326: class A). In this case, use a probe with coaxial version.

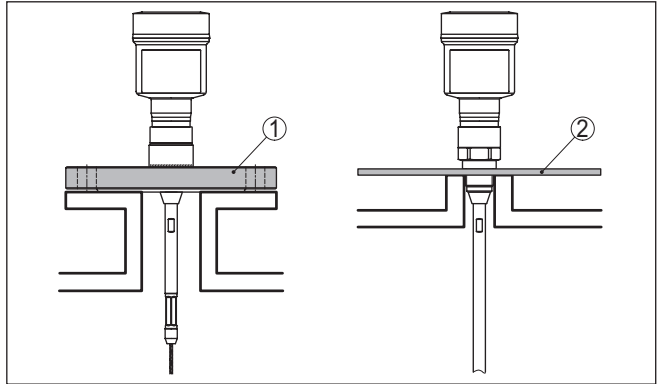

Fig. 5: Mounting in non-metallic vessel

- 1 Flange
- 2 Metal sheet

### Mounting socket

If possible, avoid sockets. Mount the sensor flush with the vessel top. If this is not possible, use short sockets with small diameter.

Higher sockets or sockets with a bigger diameter can generally be used. They can, however, increase the upper dead zone. Check if this is relevant for your measurement.

In such cases, always carry out a false signal suppression after mounting. You can find further information under "Setup procedure".

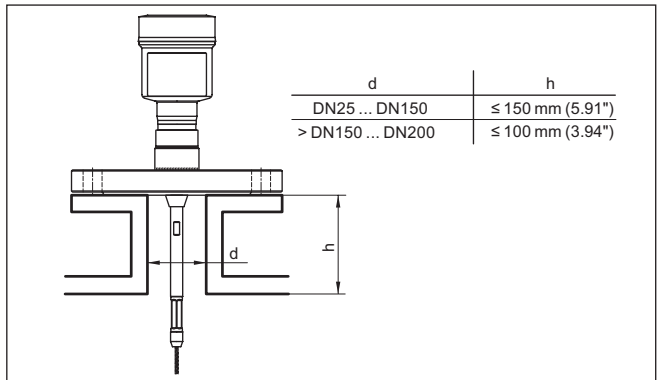

Fig. 6: Mounting socket

When welding the socket, make sure that the socket is flush with the vessel top.

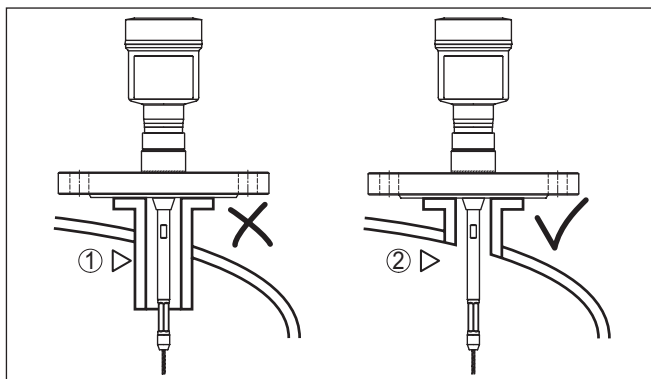

Fig. 7: Socket must be installed flush

- 1 Unfavourable mounting
- 2 Socket flush - optimum mounting

### Welding work

Before beginning the welding work, remove the electronics module from the sensor. By doing this, you avoid damage to the electronics through inductive coupling.

### Inflowing medium

Do not mount the instruments in or above the filling stream. Make sure that you detect the medium surface, not the inflowing product.

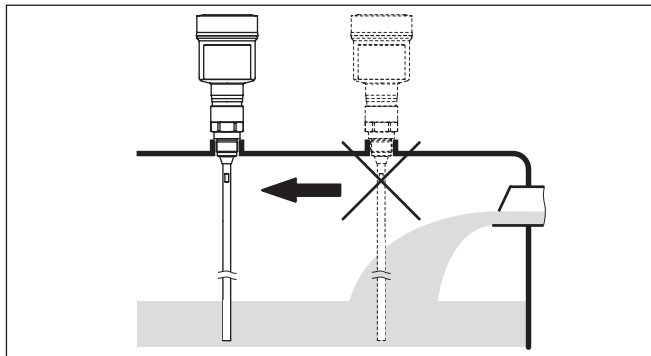

Fig. 8: Mounting of the sensor with inflowing medium

### Measuring range

The reference plane for the measuring range of the sensors is the sealing surface of the thread or flange.

Keep in mind that a min. distance must be maintained below the reference plane and possibly also at the end of the probe - measurement in these areas is not possible (dead zone). The length of the cable can be used all the way to the end only when measuring conductive products. These dead zones for different mediums are listed in chapter "Technical data". Keep in mind for the adjustment that the default setting for the measuring range refers to water.



---

## Pressure

The process fitting must be sealed if there is gauge or low pressure in the vessel. Before use, check if the seal material is resistant against the measured product and the process temperature.

The max. permissible pressure is specified in chapter "*Technical data*" or on the type label of the sensor.

## Bypass tubes

Standpipes or bypass tubes are normally metal tubes with a diameter of 30 ... 200 mm (1.18 ... 7.87 in). Up to a diameter of 80 mm (3.15 in) such a tube corresponds to a coax measuring probe. Lateral inlets in bypass tubes do not influence the measurement.

Measuring probes can be mounted in bypass tubes up to DN 200.

For bypass tubes, select the probe length such that the dead zone of the probe is above and below the lower lateral filling openings of the bypass tube. You can thus measure the complete range of the medium in the bypass tube (h). When designing the bypass tube, keep the dead zone of the probe in mind and select the length of the bypass tube above the upper lateral filling opening accordingly.

Microwaves can penetrate many plastics. This is why plastic tubes are problematic for measurement applications. If durability is no problem, we recommend the use of uncoated metal standpipes.

When the SITRANS LG250 is used in bypass tubes, contact with the tube wall must be avoided. We recommend for this purpose a cable probe with centering weight.



### Caution:

When mounting, make sure that the cable is straight over its entire length. A kink in the cable can cause measurement errors and contact with the tube.

With rod probes, a spacer is generally not required. However, if there is a risk of the rod probe being pressed against the tube wall by in-flowing medium, you should mount a spacer at the probe end to avoid contact with the tube wall. In the case of cable probes, the cable can be strained.

Keep in mind that the lower dead zone underneath the spacer increases if spacers are used.

Buildup can form on the spacers. Strong buildup can influence the measurement.

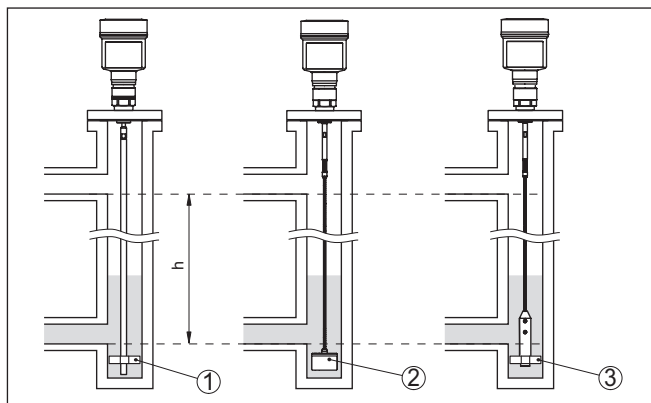

Fig. 9: Mounting in a bypass tube - Position of the spacer or the centering weight

- 1 Rod probe with spacer (PEEK)
  - 2 Cable probe with centering weight
  - 3 Spacer (PEEK) on the gravity weight of a cable probe
- h* Measurable tube section



**Note:**

Measurement in a standpipe is not recommended for extremely adhesive products. In case of slight buildup, you should choose a bypass tube with bigger diameter.

**Instructions for the measurement:**

- The 100 % point in bypass tubes should be below the upper tube connection to the vessel.
- The 0 % point in bypass tubes should be above the lower tube connection to the vessel.
- A false signal suppression with installed sensor is generally recommended to achieve the best possible accuracy.

**Standpipes**

Standpipes or surge pipes are normally metal tubes with a diameter of 30 ... 200 mm (1.18 ... 7.87 in). Up to a diameter of 80 mm (3.15 in), such a pipe corresponds to a coax measuring probe. It does not matter if the standpipe is perforated or slotted for better mixing.

Measuring probes can be mounted in standpipes up to DN 200.

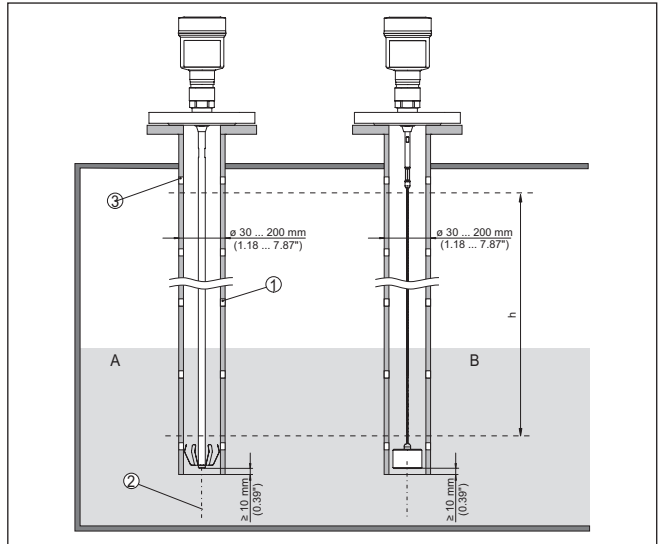

Fig. 10: Mounting in a standpipe

- 1 Holes (for mixing)
- 2 Standpipe - vertically mounted - max. deviation 10 mm (0.4 in)
- 3 Ventilation opening
- A Rod probe with spacer (steel)
- B Cable probe with centering weight
- h Measuring range

For standpipes, select the probe length such that the upper dead zone of the probe is above the upper ventilation hole. This allows you to measure the total level range of the medium in the standpipe. When designing the standpipe, keep the upper dead zone of the probe in mind and plan the length above the upper lateral filling opening accordingly.

Microwaves can penetrate many plastics. This is why plastic tubes are problematic for measurement applications. If durability is no problem, we recommend the use of uncoated metal standpipes.

When the SITRANS LG250 is used in standpipes, contact with the tube wall must be avoided. We recommend for this purpose a cable probe with centering weight.



**Caution:**

When mounting, make sure that the cable is straight over its entire length. A kink in the cable can cause measurement errors and contact with the tube.

With rod probes, a spacer is generally not required. However, if there is a risk of the rod probe being pressed against the tube wall by in-flowing medium, you should mount a spacer at the probe end to avoid contact with the tube wall. In the case of cable probes, the cable can be strained.

Keep in mind that the lower dead zone underneath the spacer increases if spacers are used.

Buildup can form on the spacers. Strong buildup can influence the measurement.



**Note:**

Measurement in a standpipe is not recommended for extremely adhesive products. In case of slight buildup, you should choose a standpipe with bigger diameter.

**Instructions for the measurement:**

- The 100 % point with standpipes should be below the upper ventilation hole.
- The 0 % point in standpipes should be above the gravity or centering weight.
- A false signal suppression with installed sensor is generally recommended to achieve the best possible accuracy.

**Fasten**

If there is a risk of the cable probe touching the vessel wall during operation due to product movements or agitators, etc., the measuring probe should be securely fixed.

There is an internal thread (M8) in the gravity weight, e.g. for an eye-bolt (optional).

Make sure that the probe cable is not completely taut. Avoid tensile loads on the cable.

Avoid undefined vessel connections, i.e. the connection must be either grounded reliably or isolated reliably. Any undefined change of this condition can lead to measurement errors.

If there is a danger of the rod probe touching the vessel wall, fasten the probe at the bottom end.

Keep in mind that measurement is not possible below the fastening point.

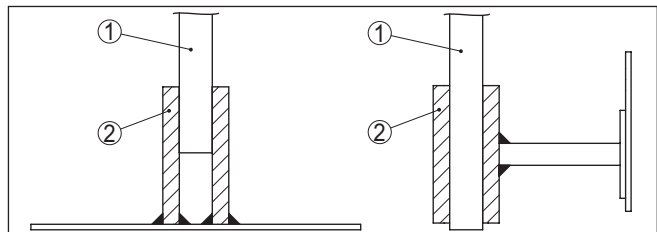

Fig. 11: Fasten the probe

- 1 Measuring probe
- 2 Retaining sleeve

**Fixing facility**

If there is a risk of the cable probe touching the vessel wall during operation due to product movements or agitators, etc., the measuring probe can be strained.

For this purpose there is an internal thread (M12 or M8) in the gravity weight.

Make sure that the probe cable is only hand tight. Avoid strong tensile loads on the cable.

Keep in mind that measurement is only possible up to the tensioning component. For this reason, order the cable probe 270 mm longer.

$$L = L1 + 270 \text{ mm (10.63 in)}$$

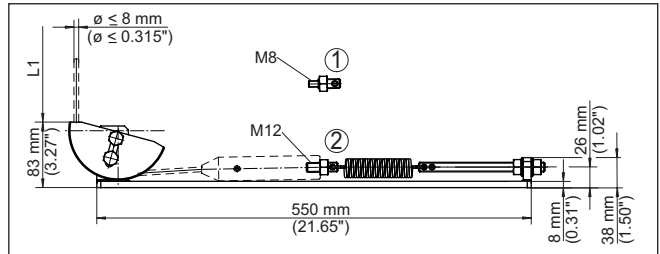

Fig. 12: Tensioning component for cable versions

- 1 Holding screw M8
  - 2 Holding screw M12
  - L1 Max. measuring length
- Probe length  $L = L1 + 270 \text{ mm (10.63 in)}$

### Lateral installation

In case of difficult installation conditions, the probe can also be mounted laterally. For this, adapt the rod with rod extensions or angled segments.

To compensate for the resulting changes in signal runtime, let the instrument determine the probe length automatically.

The determined probe length can deviate from the actual probe length when using curved or angled segments.

If internal installations such as struts, ladders, etc. are present on the vessel wall, the measuring probe should be mounted at least 300 mm (11.81 in) away from the vessel wall.

You can find further information in the supplementary instructions of the rod extension.

### Rod extension

In case of difficult installation conditions, for example in a socket, the probe can be suitably adapted with a rod extension.

To compensate for the resulting changes in signal runtime, let the instrument determine the probe length automatically.

You can find further information in the supplementary instructions of the rod and cable components.

---

## 5 Connecting to power supply

### 5.1 Preparing the connection

#### Safety instructions

Always keep in mind the following safety instructions:

- Carry out electrical connection by trained, qualified personnel authorised by the plant operator
- If overvoltage surges are expected, overvoltage arresters should be installed



#### Warning:

Only connect or disconnect in de-energized state.

#### Voltage supply

The voltage supply is provided by a Profibus DP /PA segment coupler.

The voltage supply range can differ depending on the instrument version. You can find the data for voltage supply in chapter "*Technical data*".

#### Connection cable

Connection is made with screened cable according to the Profibus specification. Power supply and digital bus signal are carried over the same two-wire connection cable.

Use cable with round cross section for instruments with housing and cable gland. To ensure the seal effect of the cable gland (IP protection rating), find out which cable outer diameter the cable gland is suitable for.

Use a cable gland fitting the cable diameter.

Make sure that the entire installation is carried out according to the Profibus specification. In particular, make sure that the bus is terminated with suitable terminating resistors.

You can find detailed information of the cable specification, installation and topology in the "*Profibus PA - User and Installation Guide-line*" on [www.profibus.com](http://www.profibus.com).

#### Cable glands

##### Metric threads

In the case of instrument housings with metric thread, the cable glands are screwed in at the factory. They are sealed with plastic plugs as transport protection.



##### Note:

You have to remove these plugs before electrical connection.

##### NPT thread

In the case of instrument housings with self-sealing NPT threads, it is not possible to have the cable entries screwed in at the factory. The free openings for the cable glands are therefore covered with red dust protection caps as transport protection.



##### Note:

Prior to setup you have to replace these protective caps with approved cable glands or close the openings with suitable blind plugs.

On plastic housings, the NPT cable gland or the Conduit steel tube must be screwed into the threaded insert without grease.

Max. torque for all housings, see chapter "Technical data".

## Cable screening and grounding

Make sure that the cable screen and grounding are carried out according to Fieldbus specification. We recommend to connect the cable screening to ground potential on both ends.

In systems with potential equalisation, connect the cable screening directly to ground potential at the power supply unit, in the connection box and at the sensor. The screen in the sensor must be connected directly to the internal ground terminal. The ground terminal outside on the housing must be connected to the potential equalisation (low impedance).

## 5.2 Connecting

### Connection technology

The voltage supply and signal output are connected via the spring-loaded terminals in the housing.

Connection to the display and adjustment module or to the interface adapter is carried out via contact pins in the housing.



#### Information:

The terminal block is pluggable and can be removed from the electronics. To do this, lift the terminal block with a small screwdriver and pull it out. When reinserting the terminal block, you should hear it snap in.

### Connection procedure

Proceed as follows:

1. Unscrew the housing lid
2. If a display and adjustment module is installed, remove it by turning it slightly to the left
3. Loosen compression nut of the cable gland and remove blind plug
4. Remove approx. 10 cm (4 in) of the cable mantle, strip approx. 1 cm (0.4 in) of insulation from the ends of the individual wires
5. Insert the cable into the sensor through the cable entry

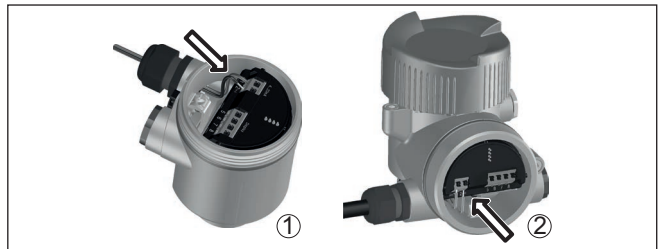

Fig. 13: Connection steps 5 and 6

- 1 Single chamber housing
- 2 Double chamber housing

6. Insert the wire ends into the terminals according to the wiring plan

**Note:**

Solid cores as well as flexible cores with wire end sleeves are inserted directly into the terminal openings. In case of flexible cores without end sleeves, press the terminal from above with a small screwdriver, the terminal opening is then free. When the screwdriver is released, the terminal closes again.

7. Check the hold of the wires in the terminals by lightly pulling on them
8. Connect the screen to the internal ground terminal, connect the external ground terminal to potential equalisation
9. Tighten the compression nut of the cable entry gland. The seal ring must completely encircle the cable
10. Reinsert the display and adjustment module, if one was installed
11. Screw the housing lid back on

The electrical connection is finished.

**5.3 Wiring plan, single chamber housing**

The following illustration applies to the non-Ex, Ex-ia and Ex-d version.

**Electronics and connection compartment**

Fig. 14: Electronics and connection compartment - single chamber housing

- 1 Voltage supply, signal output
- 2 For display and adjustment module or interface adapter
- 3 Selection switch for instrument address
- 4 For external display and adjustment unit
- 5 Ground terminal for connection of the cable screening

**5.4 Wiring plan, double chamber housing**

The following illustration applies to the non-Ex, Ex-ia and Ex-d version.

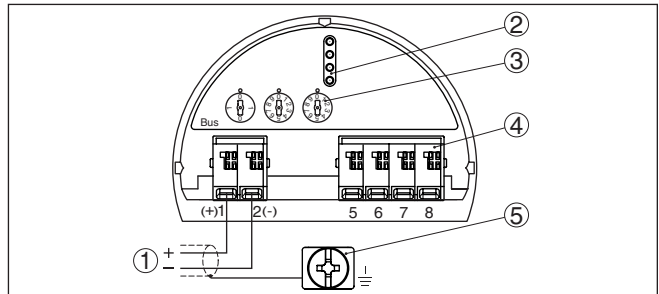

## Electronics compartment

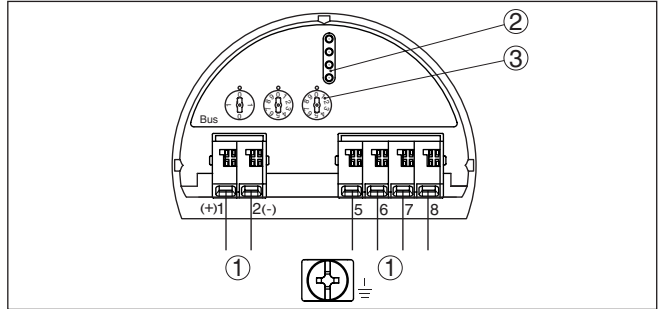

Fig. 15: Electronics compartment - double chamber housing

- 1 Internal connection to the connection compartment
- 2 Contact pins for the display and adjustment module or interface adapter
- 3 Selection switch for bus address

## Connection compartment

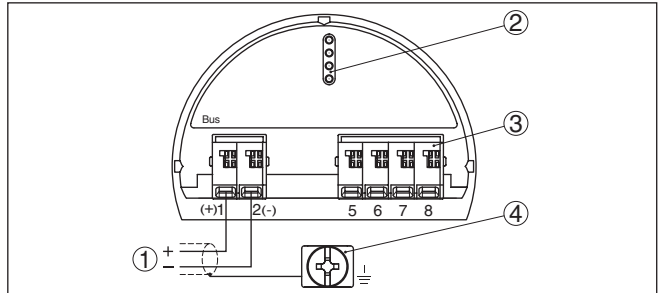

Fig. 16: Connection compartment - double chamber housing

- 1 Voltage supply, signal output
- 2 For display and adjustment module or interface adapter
- 3 For external display and adjustment unit
- 4 Ground terminal for connection of the cable screening

## 5.5 Set instrument address

### Instrument address

An address must be assigned to each Profibus PA instrument. The approved addresses are between 0 and 126. Each address must only be assigned once in the Profibus PA network. The sensor is only recognized by the control system if the address is set correctly.

When the instrument is shipped, address 126 is set. This address can be used to test the function of the instrument and to connect it to a Profibus PA network. Then the address must be changed to integrate additional instruments.

The address setting is carried out either via:

- The address selection switch in the electronics compartment of the instrument (address setting via hardware)
- The display and adjustment module (address setting via software)
- PACTware/DTM (address setting via software)

## Hardware addressing

The hardware addressing is effective if an address <126 is set with the address selection switches on the instrument. Software addressing is then no longer effective, the set hardware address applies.

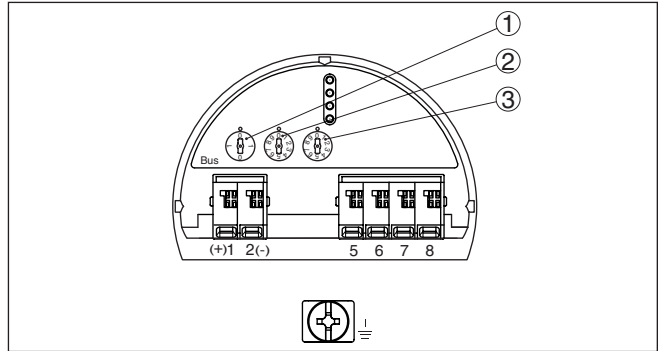

Fig. 17: Address selection switch

- 1 Addresses <100 (selection 0), addresses >100 (selection 1)
- 2 Decade of the address (selection 0 to 9)
- 3 Unit position of the address (selection 0 to 9)

## Software addressing

Software addressing is only effective if address 126 or higher is set on the instrument with the address selection switches.

The addressing procedure is described in the operating instructions manual "Display and adjustment module."

### 5.6 Switch-on phase

After connecting SITRANS LG250 to the bus system, the device first performs a self-test:

- Internal check of the electronics
- Indication of the status message "F 105 Determine measured value" on the display or PC
- Status byte goes to fault value

Then the actual measured value is output to the signal cable. The value takes into account settings that have already been carried out, e.g. default setting.

---

## 6 Set up with the display and adjustment module

### 6.1 Insert display and adjustment module

The display and adjustment module can be inserted into the sensor and removed again at any time. You can choose any one of four different positions - each displaced by 90°. It is not necessary to interrupt the power supply.

Proceed as follows:

1. Unscrew the housing lid
2. Place the display and adjustment module on the electronics in the desired position and turn it to the right until it snaps in.
3. Screw housing lid with inspection window tightly back on

Disassembly is carried out in reverse order.

The display and adjustment module is powered by the sensor, an additional connection is not necessary.



*Fig. 18: Insertion of the display and adjustment module with single chamber housing*



#### **Note:**

If you intend to retrofit the instrument with a display and adjustment module for continuous measured value indication, a higher lid with an inspection glass is required.

## 6.2 Adjustment system

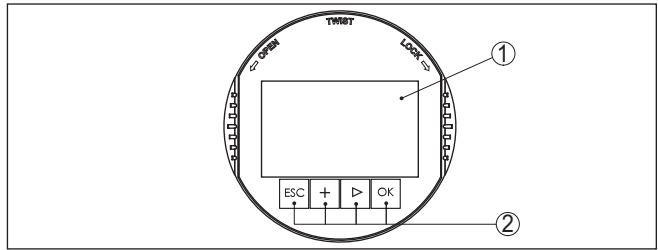

Fig. 19: Display and adjustment elements

- 1 LC display
- 2 Adjustment keys

### Key functions

- **[OK]** key:
  - Move to the menu overview
  - Confirm selected menu
  - Edit parameter
  - Save value
- **[->]** key:
  - Change measured value presentation
  - Select list entry
  - Select editing position
- **[+]** key:
  - Change value of the parameter
- **[ESC]** key:
  - Interrupt input
  - Jump to next higher menu

### Adjustment system

The sensor is operated via the four keys of the display and adjustment module. The individual menu items are shown on the LC display. You can find the function of the individual keys in the previous illustration.

When the **[+]** and **[->]** keys are pressed quickly, the edited value, or the cursor, changes one value or position at a time. If the key is pressed longer than 1 s, the value or position changes continuously.

When the **[OK]** and **[ESC]** keys are pressed simultaneously for more than 5 s, the display returns to the main menu. The menu language is then switched over to "English".

Approx. 60 minutes after the last pressing of a key, an automatic reset to measured value indication is triggered. Any values not confirmed with **[OK]** will not be saved.

### Switch-on phase

After switching on, the SITRANS LG250 carries out a short self-test where the device software is checked.

The output signal transmits a fault signal during the switch-on phase.

The following information is displayed on the display and adjustment module during the startup procedure:

- Instrument type

- Device name
- Software version (SW-Ver)
- Hardware version (HW-Ver)

### Measured value indication

With the [->] key you can move between three different indication modes.

In the first view, the selected measured value is displayed in large digits.

In the second view, the selected measured value and a corresponding bar graph presentation are displayed.

In the third view, the selected measured value as well as a second selectable value, e.g. the temperature, are displayed.



## 6.3 Parameter adjustment - Quick setup

### Quick setup

To quickly and easily adapt the sensor to the application, select the menu item "Quick setup" in the start graphic on the display and adjustment module.



The following steps for the quick setup can be reached also in the "Extended adjustment".

- Instrument address
- Measurement loop name
- Medium type (optional)
- Application
- Max. adjustment
- Min. adjustment
- False signal suppression

You can find the description of the individual menu items in the following chapter "Parameter adjustment - Extended adjustment".

## 6.4 Parameter adjustment - Extended adjustment

For technically demanding measuring points, you can carry out extended settings in "Extended adjustment".

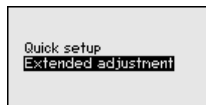

### Main menu

The main menu is divided into five sections with the following functions:

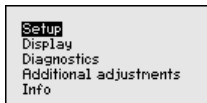

**Setup:** Settings, e.g. measurement loop name, medium, application, vessel, adjustment, AI FB 1 Channel - Scaling - Damping, device units, false signal suppression, linearization

**Display:** Language setting, settings for the measured value indication as well as lighting

**Diagnosis:** Information, for example on the instrument status, pointer, measurement reliability, AI FB 1 simulation, echo curve

**Additional adjustments:** Sensor address, PIN, date/time, reset, copy sensor data

**Info:** Instrument name, hardware and software version, date of manufacture, instrument features



**Note:**

For optimum adjustment of the measuring point, the individual sub-menu items in the main menu item "Setup" should be selected one after the other and provided with the correct parameters. If possible, go through the items in the given sequence.

The procedure is described below.

The following submenu points are available:

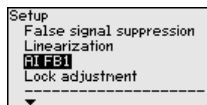
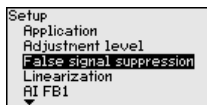
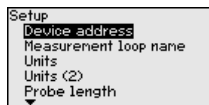

The submenu points are described below.

### 6.4.1 Setup

#### Instrument address

An address must be assigned to each Profibus PA instrument. Each address may only be assigned once in the Profibus PA network. The sensor is only recognized by the control system if the address is set correctly.

When the instrument is shipped, address 126 is set. This address can be used to test the function of the instrument and to connect it to a Profibus PA network. Then the address must be changed to integrate additional instruments.

The address setting is carried out either via:

- The address selection switch in the electronics compartment of the instrument (address setting via hardware)
- The display and adjustment module (address setting via software)
- PACTware/DTM (address setting via software)

#### Hardware addressing

Hardware addressing is effective if an address less than 126 is set with the address selection switches on the electronics module of SITRANS LG250. In such case, software addressing has no effect - only the set hardware address applies.

---

## Software addressing

Software addressing is only effective if address 126 or higher is set on the instrument with the address selection switches.

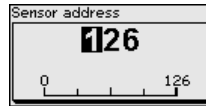

**Measurement loop name** Here you can assign a suitable measurement loop name. Push the "OK" key to start the editing. With the "+" key you change the sign and with the "->" key you jump to the next position.

You can enter names with max. 19 characters. The character set comprises:

- Capital letters from A ... Z
- Numbers from 0 ... 9
- Special characters + - / \_ blanks

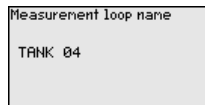

**Units** In this menu item you select the distance unit and the temperature unit.

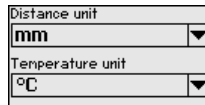

For the distance units you can choose between m, mm and ft and for the temperature units °C, °F and K.

**Units (2)** In this menu item, you select the unit of the Secondary Value (SV2).

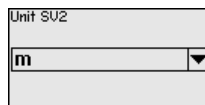

It can be selected from the distance units such as for example m, mm and ft.

**Probe length** In this menu item you can enter the probe length or have the length determined automatically by the sensor system.

When choosing "Yes", then the probe length will be determined automatically. When choosing "No", you can enter the probe length manually.

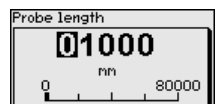
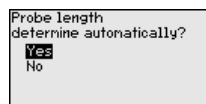
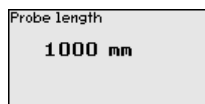

## Application - Medium type

In this menu item you can select which type of medium you want to measure. You can choose between liquid or bulk solid.

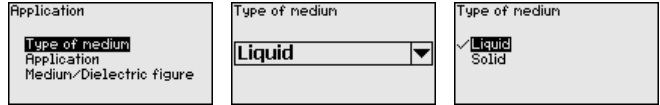

## Application - Application

In this menu item, you can select the application. You can choose between level measurement and interface measurement. You can also choose between measurement in a vessel or in a bypass or standpipe.



### Note:

The selection of the application has a considerable influence on all other menu items. Keep in mind that as you continue with the parameter adjustment, individual menu items are only optionally available.

You have the option of choosing the demonstration mode. This mode is only suitable for test and demonstration purposes. In this mode, the sensor ignores the parameters of the application and reacts immediately to any change.

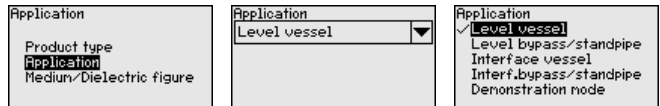

## Application - Medium, dielectric constant

In this menu item, you can define the type of medium (product).

This menu item is only available if you have selected level measurement under the menu item "Application".

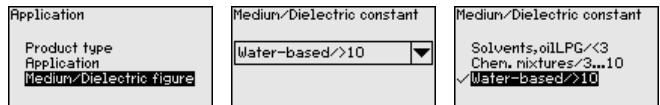

You can choose between the following medium types:

Dielectric constant	Type of medium	Examples
> 10	Water-based liquids	Acids, alcalis, water
3 ... 10	Chemical mixtures	Chlorobenzene, nitro lacquer, aniline, isocyanate, chloroform
< 3	Hydrocarbons	Solvents, oils, liquid gas

## Application - Gas phase

This menu item is only available, if you have chosen interface measurement under the menu item "Application". In this menu item you can enter if there is a superimposed gas phase in your application.

Only set the function to "Yes", if the gas phase is permanently present.



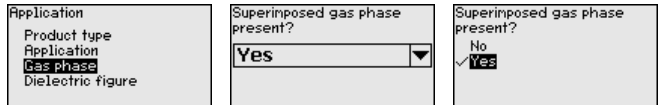

## Application - Dielectric constant

This menu item is only available if you have selected interface measurement under the menu item "Application". In this menu item you can enter the dielectric constant of the upper medium.



You can directly enter the dielectric constant of the upper medium or have the value determined by the instrument.

If you want the dielectric constant to be determined by the instrument, you have to enter the measured or known distance to the interface.

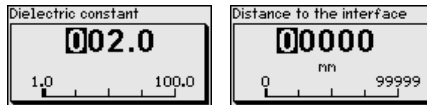

## Max. adjustment level

In this menu item you can enter the max. adjustment for the level. With interface measurement this is the maximum total level.

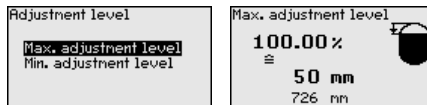

Adjust the requested percentage value with **[+]** and store with **[OK]**.

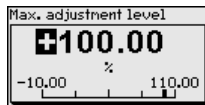

Enter the appropriate distance value in m (corresponding to the percentage value) for the full vessel. The distance refers to the sensor reference plane (seal surface of the process fitting). Keep in mind that the max. level must lie below the dead zone.

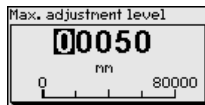

## Min. adjustment level

In this menu item you can enter the min. adjustment for the level. With interface measurement this is the minimum total level.

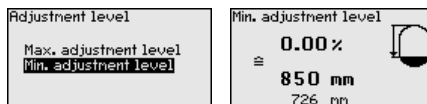

Adjust the requested percentage value with **[+]** and store with **[OK]**.

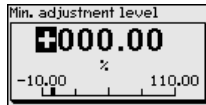

Enter the suitable distance value in m for the empty vessel (e.g. distance from the flange to the probe end) corresponding to the percentage value. The distance refers to the sensor reference plane (seal surface of the process fitting).

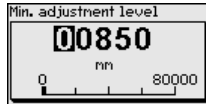

**Max. adjustment interface** This menu item is only available if you have selected interface measurement under the menu item "Application".

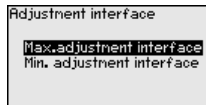

Enter the requested percentage value for the max. adjustment.

As an alternative, you have the possibility taking over the adjustment of the level measurement also for the interface.

Enter the respective distance value in m for the surface of the upper medium corresponding to the percentage value.

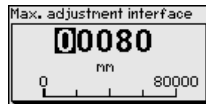
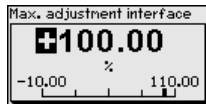

**Min. adjustment interface** This menu item is only available if you have selected interface measurement under the menu item "Application".

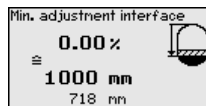
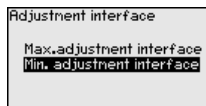

Enter the requested percentage value for the min. adjustment (interface).

Enter the respective distance value in m for the interface corresponding to the percentage value of the interface.

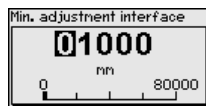
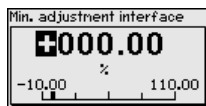

**False signal suppression** The following circumstances cause interfering reflections and can influence the measurement:

- High mounting sockets
- Vessel internals such as struts



**Note:**

A false signal suppression detects, marks and saves these false signals so that they are no longer taken into account for the level and interface measurement. We generally recommend carrying out a false signal suppression to achieve the best possible accuracy. This should be done with the lowest possible level so that all potential interfering reflections can be detected.

Proceed as follows:

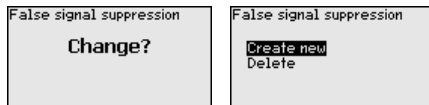

Select first if the probe is covered or uncovered.

If the probe is covered, enter the actual distance from the sensor to the product surface.

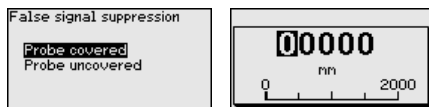

All interfering signals in this section are detected by the sensor and stored.

Keep in mind that with covered probe only false signals in the uncovered area of the probe are detected.



**Note:**

Check the distance to the product surface, because if an incorrect (too large) value is entered, the existing level will be saved as a false signal. The level would then no longer be detectable in this area.

If a false signal suppression has already been created in the sensor, the following menu window appears when selecting "False signal suppression":

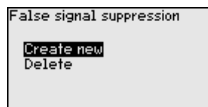

The instrument carries out an automatic false signal suppression as soon as the probe is uncovered. The false signal suppression is always updated.

The menu item "Delete" is used to completely delete an already created false signal suppression. This is useful if the saved false signal suppression no longer matches the metrological conditions in the vessel.

**Linearisation**

A linearisation is necessary for all vessels in which the vessel volume does not increase linearly with the level - e.g. a horizontal cylindrical or spherical tank, when the indication or output of the volume is required. Corresponding linearisation curves are preprogrammed for these vessels. They represent the correlation between the level percentage and vessel volume.

The linearisation applies to the measured value indication and the current output. By activating the appropriate curve, the volume percentage of the vessel is displayed correctly. If the volume should not be displayed in percent but e.g. in l or kg, a scaling can be also set in the menu item "Display".

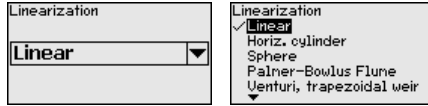

**Warning:**

If a linearisation curve is selected, the measuring signal is no longer necessarily linear to the filling height. This must be considered by the user especially when setting the switching point on the limit signal transmitter.

In the following, you have to enter the values for your vessel, for example the vessel height and the socket correction.

For non-linear vessel forms, enter the vessel height and the socket correction.

For the vessel height, you have to enter the total height of the vessel.

For the socket correction you have to enter the height of the socket above the upper edge of the vessel. If the socket is lower than the upper edge of the vessel, this value can also be negative.

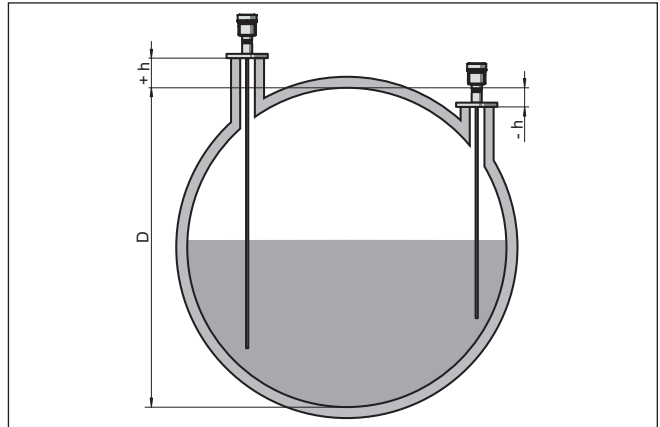
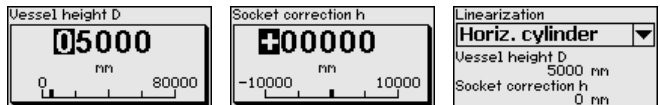

Fig. 20: Vessel height and socket correction value

D Vessel height

+h Positive socket correction value

-h Negative socket correction value



## AI FB1

Since the adjustment is very comprehensive, the menu points of Function Blocks 1 (FB1) were put together in a submenu.

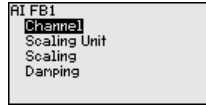

### AI FB1 - Channel

In menu item "*Channel*" you determine which measured value the output refers to.

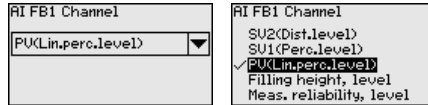

### AI FB1 - scaling unit

In menu item "*Scaling unit*" you define the scaling variable and the scaling unit for the level value on the display, e.g. volume in l.

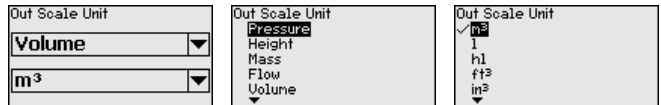

### AI FB1 - scaling

In menu item "*Scaling*" you define the scaling format on the display and the scaling of the measured level values for 0 % and 100 %.

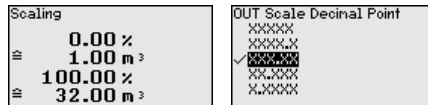

Level measured value min.

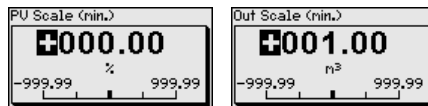

Measured level value max.

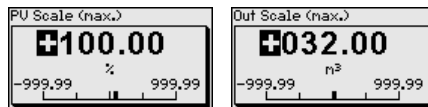

### AI FB1 - damping

To damp process-dependent measured value fluctuations, you can set a time of 0 ... 999 s in this menu item.

The damping applies to the level and interface measurement.

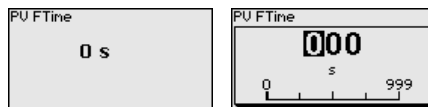

The default setting is a damping of 0 s.

## Lock/Unlock adjustment

In the menu item "Lock/unlock adjustment", you can protect the sensor parameters against unauthorized or inadvertent modification. The PIN is activated/deactivated permanently.

With active PIN, only the following adjustment functions are possible without entering a PIN:

- Select menu items and show data
- Read data from the sensor into the display and adjustment module

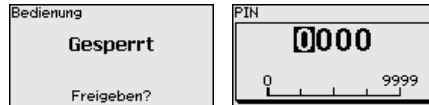

### Caution:

When the PIN is active, adjustment via PACTware/DTM as well as other systems is also blocked.

In delivery status, the PIN is **0000**.

Call our service department if you have modified and forgotten the PIN.

## 6.4.2 Display

### Display

In the main menu point "Display", the individual submenu points should be selected one after the other and provided with the correct parameters to ensure the optimum adjustment of the display options. The procedure is described in the following.

The following submenu points are available:

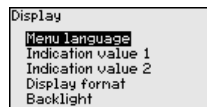

The submenu points are described below.

### Menu language

This menu item enables the setting of the requested national language.

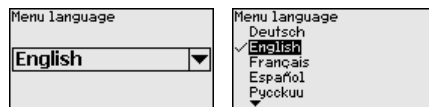

In delivery status, the sensor is set to English.

### Displayed value 1

In this menu item, you define the indication of the measured value on the display. You can display two different measured values. In this menu item, you define measured value 1.

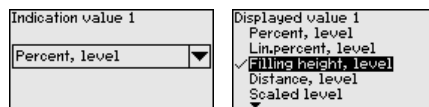

The default setting for the displayed value 1 is "Filling height Level".

## Displayed value 2

In this menu item, you define the indication of the measured value on the display. You can display two different measured values. In this menu item, you define measured value 2.

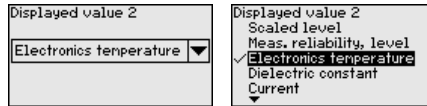

The default setting for the displayed value 2 is the electronics temperature.

## Display format

In this menu item, you define the display format of the measured value on the display. You can define different display formats for the two measured values.

You can thus define the number of decimal positions the measured value is displayed with.

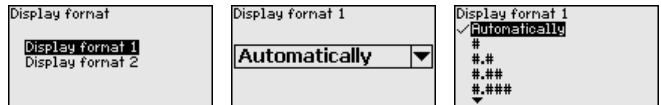

The default setting for the display format is "Automatic".

## Backlight

The integrated background lighting can be switched off via the adjustment menu. The function depends on the strength of the supply voltage, see "Technical data".

To maintain the function of the device, the lighting is temporarily switched off if the power supply is insufficient.



In delivery status, the lighting is switched on.

## 6.4.3 Diagnostics

### Sensor status

In this menu item, the device status is displayed.

When the instrument displays a failure message, you can here get detailed information on the failure reason.

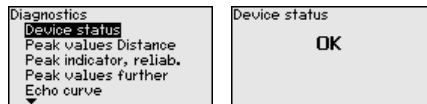

### Peak values, distance

The respective min. and max. measured value is saved in the sensor. The two values are displayed in the menu item "Peak values, distance".

If you have selected interface measurement under the menu item "Setup - Application", the peak values of the interface measurement are displayed in addition to the peak values of the level measurement.

Diagnostics
Device status
Peak values Distance
Peak indicator, reliab.
Peak values further
Echo curve
▼

Distance to the level
Min. 68 nm
Max. 265 nm
Distance to the interface
Min. 132 nm
Max. 322 nm

In another window you can carry out a reset of the two peak values separately.

Reset peak indicator
Distance to the level
Distance to the interface

### Peak values, measurement reliability

The respective min. and max. measured values are saved in the sensor. The two values are displayed in the menu item "*Peak values, measurement reliability*".

The measurement can be influenced by the process conditions. In this menu item, the measurement reliability of the level measurement is displayed in mV. The higher the value, the more reliable the measurement.

If you have selected interface measurement under the menu item "*Setup - Application*", the peak values of the interface measurement are displayed in addition to the peak values of the level measurement.

Diagnostics
Device status
Peak values Distance
Peak indicator, reliab.
Peak values further
Echo curve
▼

Meas. reliability, level
Min. 1 mV
Max. 279 mV
Meas. reliability, interface
Min. 1 mV
Max. 316 mV

In another window you can carry out a reset of the two peak values separately.

Reset peak indicator
Meas. reliability, level
Meas. reliab. interface

### Peak values, additional

The respective min. and max. measured values are saved in the sensor. The values are displayed in the menu item "*Peak values Additional*".

This menu item displays the peak values of the electronics temperature as well as the dielectric constant.

Diagnostics
Peak values Distance
Peak indicator, reliab.
Peak values further
Echo curve
Simulation
▼

Electronics temperature
Min. 27,28 °C
Max. 28,84 °C
Dielectric constant
Min. 1,00
Max. 1,00

In another window you can carry out a reset of the two peak values separately.

Reset peak indicator
Electronics temperature
Dielectric constant





### Information:

If one of the display values flashes, there is actually no valid value available.

## Echo curve

The menu item "Echo curve" shows the signal strength of the echoes over the measuring range in V. The signal strength enables an evaluation of the quality of the measurement.

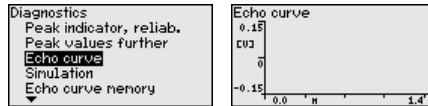

With the following functions you can zoom part sections of the echo curve.

- "X-Zoom": Zoom function for the meas. distance
- "Y-Zoom": 1, 2, 5 and 10x signal magnification in "V"
- "Unzoom": Reset the presentation to the nominal measuring range without magnification

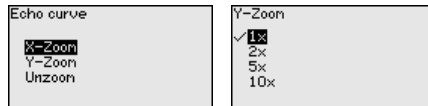

## Simulation

In this menu item you can simulate measured values via the current output. This allows the signal path to be tested, e.g. through downstream indicating instruments or the input card of the control system.

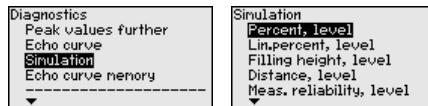

Select the requested simulation variable and set the requested value.

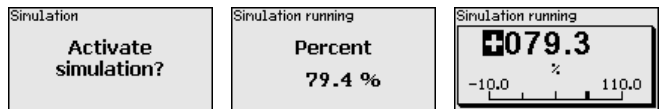

Push the [ESC] key to deactivate the simulation.



### Information:

The simulation is terminated automatically 60 minutes after the activation of the simulation.

## Echo curve memory

With the menu item "Setup" the echo curve it is possible to save at the time of setup. This is generally recommended; for using the Asset Management functions it is necessary. If possible, the curve should be saved with a low level in the vessel.

With this, you can detect signal changes over the operating time. With the adjustment software PACTware and the PC, the high-resolution echo curve can be displayed and used to compare the echo curve of the setup with the actual echo curve.

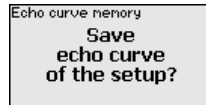
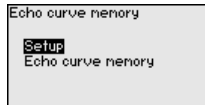

The function "Echo curve memory" enables storing echo curves of the measurement.

Under the sub-menu item "Echo curve memory" you can store the current echo curve.

Parameter settings for recording the echo curve and the settings of the echo curve itself can be carried out in the adjustment software PACTware.

With the adjustment software PACTware and the PC the high-resolution echo curve can be displayed and used later on to assess the quality of the measurement.

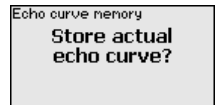
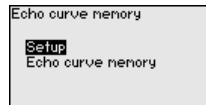
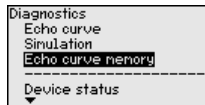

#### 6.4.4 Additional adjustments

##### Date/Time

In this menu item, the internal clock of the sensor is set.

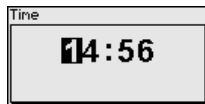
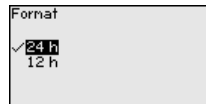
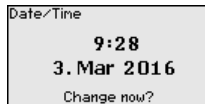

##### Reset

After a reset, certain parameter adjustments made by the user are reset.



##### Note:

After this menu window, the reset process is carried out. No further safety inquiry follows.



The following reset functions are available:

**Delivery status:** Restores the parameter settings at the time of shipment from the factory, incl. order-specific settings. Any stored false signal suppression or user-programmed linearisation curve, as well as the measured value memory, are deleted.

**Basic settings:** Resetting of the parameter settings incl. special parameters to the default values (presettings) of the respective instru-

ment. Any created false signal suppression or user-programmable linearization curve as well as the measured value memory are deleted.

The following table shows the default values of the instrument. Depending on the instrument version or application, all menu items may not be available or some may be differently assigned:

## Menu - Setup

Menu item	Default value
Lock adjustment	Released
Measurement loop name	Sensor
Units	Distance unit: order-specific Temperature unit: order-specific
Probe length	Länge der Messsonde factory setting
Type of medium	Liquid
Application	Level in the vessel
Medium, dielectric constant	Water-based, > 10
Superimposed gas phase	Yes
Dielectric constant, upper medium (TS)	1.5
Tube inner diameter	200 mm
Max. adjustment - Level	100 %
Max. adjustment - Level	Distance: 0.000 m(d) - Note dead zones
Min. adjustment - Level	0 %
Min. adjustment - Level	Distance: Probe length - Note dead zones
Accept adjustment of the level measurement?	No
Max. adjustment - Interface	100 %
Max. adjustment - Interface	Distance: 0.000 m(d) - Note dead zones
Min. adjustment - Interface	0 %
Min. adjustment - Interface	Distance: Probe length - Note dead zones
Integration time - Level	0.0 s
Integration time - Interface	0.0 s
Linearisation type	Linear
Linearisation - Socket correction	0 mm
Linearisation - Vessel height	Probe length
AI FB1 Tag Descriptor	
AI FB1 Channel	Primary Value (lin. percent level)
AI FB1 scaling PV Scale (min.)	0 %
AI FB1 scaling PV Scale (max.)	100 %
AI FB1 Lin. Type	Linear
AI FB1 Out Scale Unit	%
AI FB1 Out Scale Decimal Point	#.##

Menu item	Default value
AI FB1 Out Scale (min.)	0 %
AI FB1 Out Scale (max.)	100 %
AI FB1 PV FTime	0 s
AI FB1 Hi Hi Limit	3.402823E+38 %
AI FB1 Hi Limit	3.402823E+38 %
AI FB1 Lo Lo Limit	-3.402823E+38 %
AI FB1 Lo Limit	-3.402823E+38 %
AI FB1 Hysteresis	0.50 %
AI FB1 Fail Safe Mode (behaviour in case of malfunction)	Last Valid Out Value (last valid measured value)
AI FB1 Fail Safe Value	0.00 %
AI FB1 Target Mode	Auto

### Menu - Display

Menu item	Default value
Language	Selected language
Displayed value 1	Filling height Level
Displayed value 2	Electronics temperature
Backlight	Switched on

### Menu - Diagnosis

Menu item	Default value
Status signals - Function control	Switched on
Status signals - Out of specification	Switched off
Status signals - Maintenance	Switched off
Device memory - Echo curve memory	Stopped
Device memory - Measured value memory	Started
Device memory - Measured value memory - Measured values	Distance level, percentage value level, reliability level, electronics temperature
Device memory - Measured value memory - Recording in time interval	3 min.
Device memory - Measured value memory - Recording with measured value difference	15 %
Device memory - Measured value memory - Start with measured value	Not active
Device memory - Measured value memory - Stop with measured value	Not active
Device memory - Measured value memory - Stop recording when memory is full	Not active

## Menu - Additional adjustments

Menu item	Default value
PIN	0000
Date	Actual date
Time	Actual time
Time - Format	24 hours
Probe type	Device-specific
AI FB2 Tag Descriptor	
AI FB 2 Channel	Primary Value (lin. percent level)
AI FB2 scaling PV Scale (min.)	0 %
AI FB2 scaling PV Scale (max.)	100 %
AI FB2 Lin. Type	Linear
AI FB2 Out Scale Unit	%
AI FB2 Out Scale Decimal Point	#.##
AI FB2 Out Scale (min.)	0 %
AI FB2 Out Scale (max.)	100 %
AI FB2 PV FTime	0 s
AI FB2 Hi Hi Limit	3.402823E+38 %
AI FB2 Hi Limit	3.402823E+38 %
AI FB2 Lo Lo Limit	-3.402823E+38 %
AI FB2 Lo Limit	-3.402823E+38 %
AI FB2 Hysteresis	0.50 %
AI FB2 Fail Safe Mode (behaviour in case of malfunction)	Last Valid Out Value (last valid measured value)
AI FB2 Fail Safe Value	0.00 %
AI FB2 Target Mode	Auto
AI FB3 Tag Descriptor	
AI FB3 Channel	Primary Value (lin. percent level)
AI FB1 scaling PV Scale (min.)	0 %
AI FB3 scaling PV Scale (max.)	100 %
AI FB3 Lin. Type	Linear
AI FB3 Out Scale Unit	%
AI FB3 Out Scale Decimal Point	#.##
AI FB3 Out Scale (min.)	0 %
AI FB3 Out Scale (max.)	100 %
AI FB3 PV FTime	0 s
AI FB3 Hi Hi Limit	3.402823E+38 %
AI FB3 Hi Limit	3.402823E+38 %
AI FB3 Lo Lo Limit	-3.402823E+38 %

Menu item	Default value
AI FB3 Lo Limit	-3.402823E+38 %
AI FB3 Hysteresis	0.50 %
AI FB3 Fail Safe Mode (behaviour in case of malfunction)	Last Valid Out Value (last valid measured value)
AI FB3 Fail Safe Value	0.00 %
AI FB3 Target Mode	Auto

**Copy instrument settings** The instrument settings are copied with this function. The following functions are available:

- **Read from sensor:** Read data from sensor and store into the display and adjustment module
- **Write into sensor:** Store data from the display and adjustment module back into the sensor

The following data or settings for adjustment of the display and adjustment module are saved:

- All data of the menu "Setup" and "Display"
- In the menu "Additional adjustments" the items "Reset, Date/Time"
- Special parameters

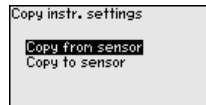
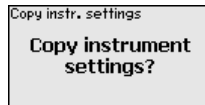

#### Prerequisites

The following requirements must be met for a successful transmission:

- The data can only be transferred to the same device type, e.g. SITRANS LG250
- It must be the same probe type, e.g. rod probe
- The firmware of both devices is identical

The copied data are permanently saved in an EEPROM memory in the display and adjustment module and remain there even in case of power failure. From there, they can be written into one or more sensors or kept as backup for a possible electronics exchange.



#### Note:

Before the data are stored in the sensor, a check is carried out to determine if the data fit the sensor. If the data do not fit, a fault signal is triggered or the function is blocked. When data are being written into the sensor, the display shows which instrument type the data originate from and which TAG-no. this sensor had.



#### Tip:

We recommend to save the instrument adjustments. In case of an electronics exchange the saved parameter adjustment data relieve this process.

## Probe type

In this menu item you can select the type and size of your probe from a list of all possible probes. This is necessary to adapt the electronics optimally to the probe.

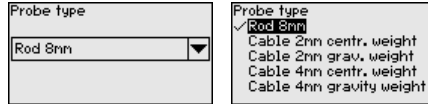

## Special parameters

In this menu item you gain access to the protected area where you can enter special parameters. In exceptional cases, individual parameters can be modified in order to adapt the sensor to special requirements.

Change the settings of the special parameters only after having contacted our service staff.



## 6.4.5 Info

### Device name

In this menu, you read out the instrument name and the instrument serial number.

### Instrument version

In this menu item, the hardware and software version of the sensor is displayed.

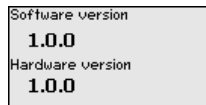

### Factory calibration date

In this menu item, the date of factory calibration of the sensor as well as the date of the last change of sensor parameters are displayed via the display and adjustment module or via the PC.

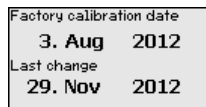

### Profibus Ident Number

In this menu item, the Profibus ident number of your sensor is displayed.

### Sensor characteristics

In this menu item, the features of the sensor such as approval, process fitting, seal, measuring range, electronics, housing and others are displayed.

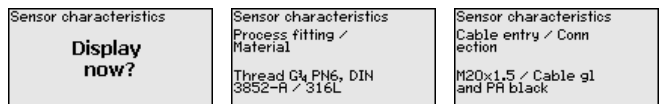

Example for displayed sensor features.

---

## 6.5 Saving the parameterisation data

### On paper

We recommended writing down the adjustment data, e.g. in this operating instructions manual, and archiving them afterwards. They are thus available for multiple use or service purposes.

### In the display and adjustment module

If the instrument is equipped with a display and adjustment module, the parameter adjustment data can be saved therein. The procedure is described in menu item "*Copy device settings*".



---

## 7 Setup with PACTware

### 7.1 Connect the PC

Via the interface adapter  
directly on the sensor

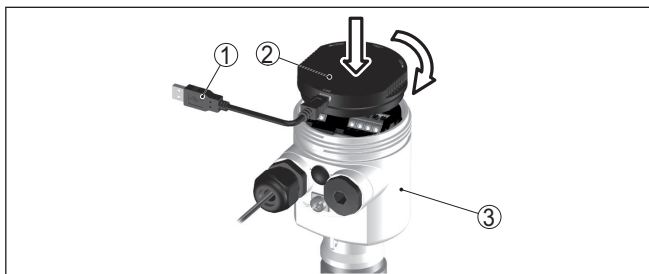

Fig. 21: Connection of the PC directly to the sensor via the interface adapter

- 1 USB cable to the PC
- 2 Interface adapter
- 3 Sensor

### 7.2 Parameter adjustment with PACTware

#### Prerequisites

For parameter adjustment of the sensor via a Windows PC, the configuration software PACTware and a suitable instrument driver (DTM) according to FDT standard are required. The available DTMs are compiled on a DVD. The DTMs can also be integrated into other frame applications according to FDT standard.



#### Note:

To ensure that all instrument functions are supported, you should always use the latest DTM Collection. Furthermore, not all described functions are included in older firmware versions. You can download the latest instrument software from our homepage. A description of the update procedure is also available in the Internet.

The further setup steps are described in the online help of PACTware and the DTMs.

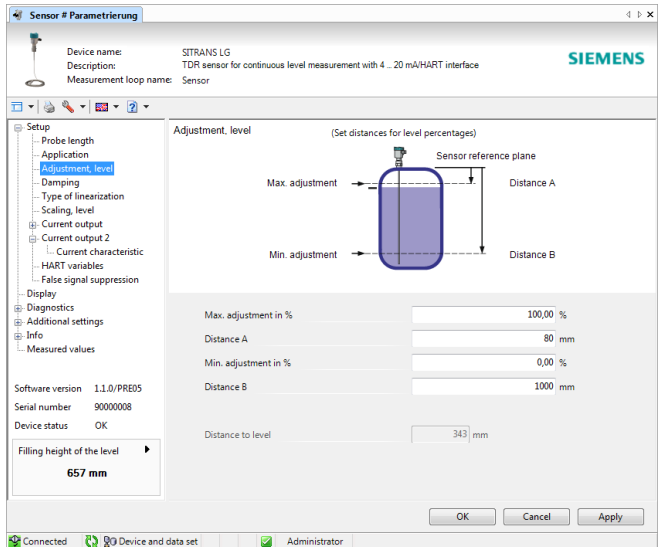

Fig. 22: Example of a DTM view

## Device DTMs

The device DTM includes an assistant for simple project configuration simplifying also the adjustment considerably. You can save and print your project documentation as well as import and export projects.

You can also save measured value and echo curves in the DTM. Furthermore a tank calculation program as well as a multiviewer for indication and analysis of the saved measured value and echo curves are available.

The supplied DVD includes the respective device DTM. However, you can also download the DTM from our homepage [www.siemens.com/sitranslg](http://www.siemens.com/sitranslg).

## 7.3 Set up with the quick setup

### General information

The quick setup is another option for parameter adjustment of the sensor. It allows fast, convenient adjustment of the most important parameters to adapt the sensor quickly to standard applications. To use it, select the function "Quick setup" in the start screen.

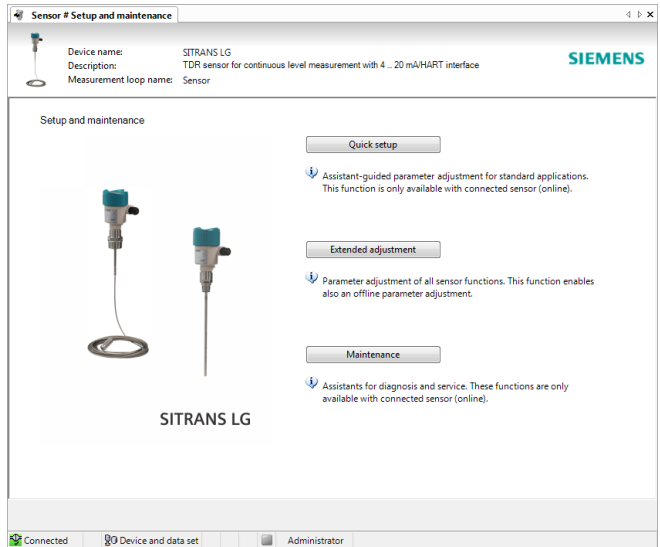

Fig. 23: Select quick setup

- 1 Quick setup
- 2 Extended adjustment
- 3 Maintenance

### Quick setup

With quick setup you can carry out the parameter adjustment of SITRANS LG250 for your application in just a few simple steps. The assistant-driven adjustment includes the basic settings for simple, reliable setup and commissioning.



### Information:

If the function is inactive, then possibly no instrument is connected. Check the connection to the instrument.

### Extended adjustment

With the extended adjustment, you carry out the parameter adjustment for the instrument via the clear menu structure in the DTM (Device Type Manager). This enables additional and special settings over and above those offered by quick setup.

### Maintenance

Under the menu item "Maintenance" you get comprehensive and important support for servicing and maintenance. You can call up diagnostic functions and carry out an electronics exchange or a software update.

## Start quick setup

Click to the button "Quick setup", to start the assistant-driven adjustment for a simplified and reliable setup.

---

## 7.4 Saving the parameterisation data

We recommend documenting or saving the parameterisation data via PACTware. That way the data are available for multiple use or service purposes.

---

## **8 Set up with other systems**

### **8.1 DD adjustment programs**

Device descriptions as Enhanced Device Description (EDD) are available for DD adjustment programs such as, for example, AMS† and PDM.

---

## 9 Diagnostics and servicing

### 9.1 Maintenance

#### Maintenance

If the device is used properly, no special maintenance is required in normal operation.

#### Cleaning

The cleaning helps that the type label and markings on the instrument are visible.

Take note of the following:

- Use only cleaning agents which do not corrode the housings, type label and seals
- Use only cleaning methods corresponding to the housing protection rating

### 9.2 Diagnosis memory

The instrument has several memories available for diagnostic purposes. The data remain there even in case of voltage interruption.

#### Measured value memory

Up to 100,000 measured values can be stored in the sensor in a ring memory. Each entry contains date/time as well as the respective measured value. Storable values are for example:

- Distance
- Filling height
- Percentage value
- Lin. percent
- Scaled
- Current value
- Measurement reliability
- Electronics temperature

When the instrument is shipped, the measured value memory is active and stores distance, measurement reliability and electronics temperature every 3 minutes.

In "Extended adjustment" you can select the respective measured values.

The requested values and recording conditions are set via a PC with PACTware/DTM or the control system with EDD. Data are thus read out and also reset.

#### Event memory

Up to 500 events are automatically stored with a time stamp in the sensor (non-deletable). Each entry contains date/time, event type, event description and value. Event types are for example:

- Modification of a parameter
- Switch-on and switch-off times
- Status messages (according to NE 107)
- Error messages (according to NE 107)

The data are read out via a PC with PACTware/DTM or the control system with EDD.

## Echo curve memory

The echo curves are stored with date and time and the corresponding echo data. The memory is divided into two sections:

**Echo curve of the setup:** This is used as reference echo curve for the measurement conditions during setup. Changes in the measurement conditions during operation or buildup on the sensor can thus be recognized. The echo curve of the setup is stored via:

- PC with PACTware/DTM
- Control system with EDD
- Display and adjustment module

**Further echo curves:** Up to 10 echo curves can be stored in a ring buffer in this memory section. Additional echo curves are stored via:

- PC with PACTware/DTM
- Control system with EDD
- Display and adjustment module

## 9.3 Status messages

The instrument features self-monitoring and diagnostics according to NE 107 and VDI/VDE 2650. In addition to the status messages in the following tables there are more detailed error messages available under the menu item "Diagnostics" via the respective adjustment module.

## Status messages

The status messages are divided into the following categories:

- Failure
- Function check
- Out of specification
- Maintenance requirement

and explained by pictographs:

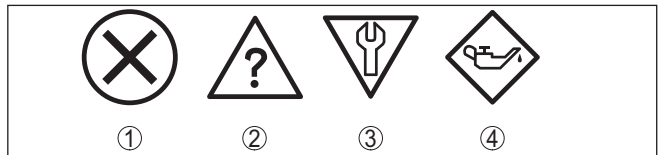

Fig. 24: Pictographs of the status messages

- 1 Failure - red
- 2 Out of specification - yellow
- 3 Function check - orange
- 4 Maintenance - blue

**Failure:** Due to a malfunction in the instrument, a fault message is output.

This status message is always active. It cannot be deactivated by the user.

**Function check:** The instrument is being worked on, the measured value is temporarily invalid (for example during simulation).

This status message is inactive by default.

**Out of specification:** The measured value is unreliable because an instrument specification was exceeded (e.g. electronics temperature).

This status message is inactive by default.

**Maintenance:** Due to external influences, the instrument function is limited. The measurement is affected, but the measured value is still valid. Plan in maintenance for the instrument because a failure is expected in the near future (e.g. due to buildup).

This status message is inactive by default.

## Failure (failure)

Code Text message	Cause	Rectification	DevSpec Diagnosis Bits
F013 no measured value available	Sensor does not detect an echo during operation Antenna system dirty or defective	Check for correct mounting and/or parameter settings Clean or exchange process component or antenna	Bit 0
F017 Adjustment span too small	Adjustment not within specification	Change adjustment according to the limit values (difference between min. and max. $\geq 10$ mm)	Bit 1
F025 Error in the linearization table	Index markers are not continuously rising, for example illogical value pairs	Check linearisation table Delete table/Create new	Bit 2
F036 No operable software	Failed or interrupted software update	Repeat software update Check electronics version Exchanging the electronics Send instrument for repair	Bit 3
F040 Error in the electronics	Hardware defect	Exchanging the electronics Send instrument for repair	Bit 4
F041 Probe loss	Cable probe broken or rod probe defective	Check probe and exchange, if necessary	Bit 13
F080 General software error	General software error	Disconnect operating voltage briefly	Bit 5
F105 Measured value is determined	The instrument is still in the start phase, the measured value could not yet be determined	Wait for the end of the switch-on phase Duration up to approx. 3 minutes depending on the version and parameter settings	Bit 6
F113 Communication error	Error in the internal instrument communication	Disconnect operating voltage briefly Send instrument for repair	-
F125 Impermissible electronics temperature	Temperature of the electronics in the non-specified range	Check ambient temperature Insulate electronics Use instrument with higher temperature range	Bit 7



<b>Code Text message</b>	<b>Cause</b>	<b>Rectification</b>	<b>DevSpec Diagnosis Bits</b>
F260 Error in the calibration	Error in the calibration carried out in the factory Error in the EEPROM	Exchanging the electronics Send instrument for repair	Bit 8
F261 Error in the instrument settings	Error during setup False signal suppression faulty Error when carrying out a reset	Repeat setup Repeat reset	Bit 9
F264 Installation/Setup error	Adjustment not within the vessel height/measuring range Max. measuring range of the instrument not sufficient	Check for correct mounting and/or parameter settings Use an instrument with bigger measuring range	Bit 10
F265 Measurement function disturbed	Sensor no longer carries out a measurement Operating voltage too low	Check operating voltage Carry out a reset Disconnect operating voltage briefly	Bit 11
F266 Impermissible operating voltage	Wrong operating voltage	Check operating voltage Check connection cables	Bit 14
F267 No executable sensor software	Sensor cannot start	Exchanging the electronics Send instrument for repair	-

Tab. 6: Error codes and text messages, information on causes as well as corrective measures

### Function check

<b>Code Text message</b>	<b>Cause</b>	<b>Rectification</b>	<b>TB Diagnostics</b>
C700 Simulation active	A simulation is active	Finish simulation Wait for the automatic end after 60 mins.	Bit 27

Tab. 7: Error codes and text messages, information on causes as well as corrective measures

### Out of specification

<b>Code Text message</b>	<b>Cause</b>	<b>Rectification</b>	<b>TB Diagnostics</b>
S600 Impermissible electronics temperature	Temperature of the processing electronics in the non-specified section	Check ambient temperature Insulate electronics Use instrument with higher temperature range	Bit 23
S601 Overfilling	Level echo in the close range not available	Reduce level 100 % adjustment: Increase value Check mounting socket Remove possible interfering signals in the close range Use coaxial probe	Bit 24

Code Text message	Cause	Rectification	TB Diagnostics
S602 Level within the search range, compensation echo	Compensation echo superimposed by medium	100 % adjustment: Increase value	Bit 25
S603 Impermissible operating voltage	Operating voltage below specified range	Check electrical connection If necessary, increase operating voltage	Bit 26

Tab. 8: Error codes and text messages, information on causes as well as corrective measures

## Maintenance

Code Text message	Cause	Rectification	TB Diagnostics
M500 Error in the delivery status	The data could not be restored during the reset to delivery status	Repeat reset Load XML file with sensor data into the sensor	Bit 15
M501 Error in the non-active linearisation table	Index markers are not continuously rising, for example illogical value pairs	Check linearisation table Delete table/Create new	Bit 16
M504 Error at a device interface	Hardware defect	Exchanging the electronics Send instrument for repair	Bit 19
M505 no measured value available	Sensor does not detect an echo during operation	Check and correct mounting and/or parameter adjustment	Bit 20
	Process component or probe contaminated or defective	Clean or exchange process component or probe	Bit 20
M506 Installation/Set-up error	Error during setup	Check and correct mounting and/or parameter adjustment Check probe length	Bit 21
M507 Error in the instrument settings	Error during setup Error when carrying out a reset False signal suppression faulty	Carry out reset and repeat setup	Bit 22

Tab. 9: Error codes and text messages, information on causes as well as corrective measures

## 9.4 Rectify faults

### Reaction when malfunction occurs

The operator of the system is responsible for taking suitable measures to rectify faults.

### Fault rectification

The first measures are:

- Evaluation of fault messages
- Checking the output signal
- Treatment of measurement errors

Further comprehensive diagnostics options are available with a PC/notebook with PACTware and the suitable DTM. In many cases, the reasons can be determined in this way and faults rectified.

### Treatment of measurement errors

The below tables show typical examples for application-relevant measurement errors. There are two measurement errors:

- Constant level
- Filling
- Emptying

The images in column "Error pattern" show the real level as a broken line and the level displayed by the sensor as a continuous line.

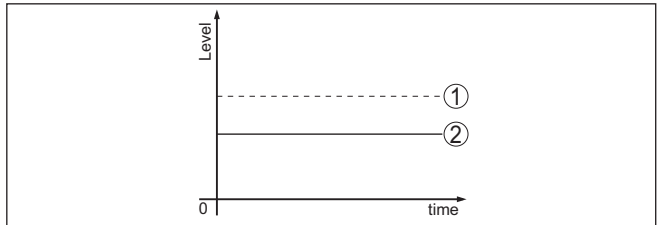

Fig. 25: The broken line 1 shows the real level, the continuous line 2 shows the level displayed by the sensor



#### Note:



If the output level is constant, the cause could also be the fault setting of the current output to "Hold value".

If the level is too low, the reason could be a line resistance that is too high



### Measurement error with constant level

Fault description	Cause	Rectification
Measured value shows a too low or too high level 	Min./max. adjustment not correct	Adapt min./max. adjustment
	Incorrect linearisation curve	Adapt linearisation curve
Measured value jumps towards 100 % 	Running time error (small measurement error close to 100 %/serious error close to 0 %)	Repeat setup
	Due to the process, the amplitude of the product echo decreases A false signal suppression was not carried out Amplitude or position of a false signal has changed (e.g. buildup); false signal suppression no longer matches	Carry out a false signal suppression Determine the reason for the changed false signals, carry out false signal suppression, e.g. with buildup

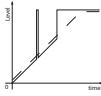
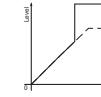
## Measurement error during filling

Fault description	Cause	Rectification
<p>Measured value remains in the area of the bottom during filling</p> 	<p>Echo from the probe end larger than the product echo, for example, with products with <math>\epsilon_r &lt; 2.5</math> oil-based, solvents, etc.</p>	<p>Check parameter "Medium" and "Vessel height", adapt if necessary</p>
<p>Measured value remains momentarily unchanged during filling and then jumps to the correct level</p> 	<p>Turbulence on the product surface, quick filling</p>	<p>Check parameters, change if necessary, e.g. in dosing vessel, reactor</p>
<p>Measured value jumps sporadically to 100 % during filling</p> 	<p>Changing condensation or contamination on the probe</p>	<p>Carry out a false signal suppression</p>
<p>Measured value jumps to <math>\geq 100\%</math> or 0 m distance</p> 	<p>Level echo is no longer detected in the close range due to false signals in the close range. The sensor goes into overfill protection mode. The max. level (0 m distance) as well as the status message "Overfill protection" are output.</p>	<p>Eliminate false signals in the close range Check installation conditions If possible, switch off the function "Overfill protection"</p>

## Measurement error during emptying

Fault description	Cause	Rectification
<p>Measured value remains unchanged in the close range during emptying</p> 	<p>False signal larger than the level echo Level echo too small</p>	<p>Eliminate false signals in the close range Remove contamination on the probe. After having removed the source of the false signals, the false signal suppression must be deleted. Carry out a new false signal suppression</p>
<p>Measured value remains reproducible in one position during emptying</p> 	<p>Stored false signals in this position are larger than the level echo</p>	<p>Delete false signal suppression Carry out a new false signal suppression</p>

## Treatment of measurement errors with bulk solids

The below tables show typical examples of application-related measurement errors with bulk solids. A distinction is made between measurement errors during:

- Constant level
- Filling
- Emptying

The images in column "Error pattern" show the real level as a broken line and the level displayed by the sensor as a continuous line.

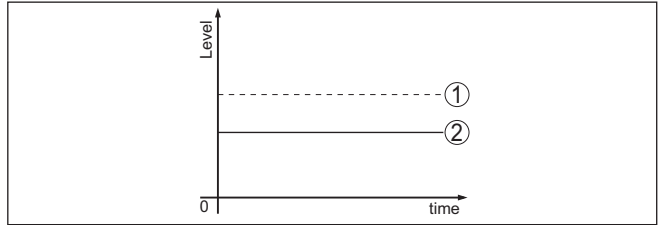

- 1 Real level  
2 Level displayed by the sensor



### Note:

If the output level is constant, the cause could also be the fault setting of the current output to "Hold value".

If the level is too low, the reason could be a line resistance that is too high

## Measurement error with constant level

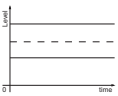
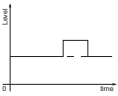
Fault description	Cause	Rectification
Measured value shows a too low or too high level 	Min./max. adjustment not correct	Adapt min./max. adjustment
	Incorrect linearisation curve	Adapt linearisation curve
Measured value jumps towards 100 % 	Due to the process, the amplitude of the product echo decreases A false signal suppression was not carried out	Carry out a false signal suppression
	Amplitude or position of a false signal has changed (e.g. condensation, buildup); false signal suppression no longer matches actual conditions	Determine the reason for the changed false signals, carry out false signal suppression, e.g. condensation

## Measurement error during filling

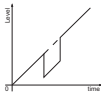
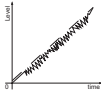
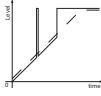
Fault description	Cause	Rectification
Measured value jumps towards 0 % during filling 	Amplitude of a multiple echo (vessel top - product surface) is larger than the level echo	Check parameter "Application", especially vessel top, type of medium, dished bottom, high dielectric constant, and adapt if necessary
	The level echo cannot be distinguished from the false signal at a false signal position (jumps to multiple echo)	In case of interferences due to installations in the close range: Change polarisation direction Chose a more suitable installation position
	Transverse reflection from an extraction funnel, amplitude of the transverse reflection larger than the level echo	Direct sensor to the opposite funnel wall, avoid crossing with the filling stream
Measured value fluctuates around 10 ... 20 % 	Various echoes from an uneven product surface, e.g. a material cone	Check parameter "Material Type" and adapt, if necessary Optimize installation position and sensor orientation
	Reflections from the product surface via the vessel wall (deflection)	Select a more suitable installation position, optimize sensor orientation, e.g. with a swivelling holder
Measured value jumps sporadically to 100 % during filling 	Varying condensation or contamination on the antenna	Carry out a false signal suppression or increase false signal suppression with condensation/contamination in the close range by editing With bulk solids use radar sensor with purging air connection or flexible antenna cover

## Measurement error during emptying

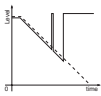
Fault description	Cause	Rectification
Measured value remains unchanged in the close range during emptying 	False signal larger than the level echo	Eliminate false signals in the close range. Check: Antenna must protrude out of the socket
	Level echo too small	Remove contamination on the antenna In case of interferences due to installations in the close range: Change polarisation direction After eliminating the false signals, the false signal suppression must be deleted. Carry out a new false signal suppression
Measured value jumps sporadically towards 100 % during emptying 	Varying condensation or contamination on the antenna	Carry out false signal suppression or increase false signal suppression in the close range by editing With bulk solids use radar sensor with purging air connection or flexible antenna cover

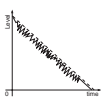
Fault description	Cause	Rectification
Measured value fluctuates around 10 ... 20 % 	Various echoes from an uneven product surface, e.g. an extraction funnel Reflections from the product surface via the vessel wall (deflection)	Check parameter "Material Type" and adapt, if necessary Optimize installation position and sensor orientation

### Reaction after fault rectification

Depending on the reason for the fault and the measures taken, the steps described in chapter "Setup" must be carried out again or must be checked for plausibility and completeness.

## 9.5 Exchanging the electronics module

If the electronics module is defective, it can be replaced by the user.



In Ex applications, only instruments and electronics modules with appropriate Ex approval may be used.

If there is no electronics module available on site, the electronics module can be ordered through the agency serving you. The electronics modules are adapted to the respective sensor and differ in signal output or voltage supply.

The new electronics module must be loaded with the default settings of the sensor. These are the options:

- In the factory
- Or on site by the user

In both cases, the serial number of the sensor is needed. The serial numbers are stated on the type label of the instrument, on the inside of the housing as well as on the delivery note.

When loading on site, the order data must first be downloaded from the Internet (see operating instructions "*Electronics module*").



#### Caution:

All application-specific settings must be entered again. That's why you have to carry out a fresh setup after exchanging the electronics.

If you saved the parameter settings during the first setup of the sensor, you can transfer them to the replacement electronics module. A fresh setup is then not necessary.

## 9.6 Exchanging the cable/rod

### Exchanging the cable/rod

If necessary, the cable or rod (measuring part) of the probe can be exchanged.

Loosen the rod or cable with a fork wrench, wrench size 7 (rod  $\varnothing$  8, cable  $\varnothing$  2 and 4) or wrench size 10 (rod  $\varnothing$  12).



#### Note:

When exchanging the rod or cable, make sure that the instrument and the new rod or cable are dry and clean.

1. Loosen the rod or cable with a fork wrench applied to the flat surface, provide counterforce with another fork wrench.
2. Dry the process fitting and the upper rod end before unscrewing the measuring rod.
3. Unscrew the loosened rod or cable manually.
4. Insert the new measuring rod carefully by hand with a screwing motion into the opening of the process fitting.
5. Continue screwing in the rod manually into the opening of the process fitting.
6. Exert counterforce with the second fork spanner and tighten the rod or cable on the flat surfaces with the following torque.  
 Rod  $\varnothing$  8, cable  $\varnothing$  2 and 4: 6 Nm (4.43 lbf ft)  
 Rod  $\varnothing$  12: 10 Nm (7.37 lbf ft)

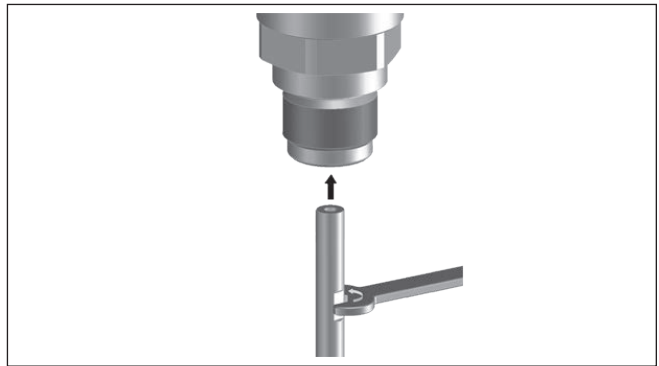

Fig. 26: Exchange cable or rod



**Information:**

Please maintain the specified torque so that the max. tensile strength of the connection remains.

7. Enter new probe length and if necessary the new probe type and then carry out a fresh adjustment (see "Setup procedure, Carrying out min. adjustment - Carrying out max. adjustment").

**Shorten cable/rod**

The rod or cable of the probe can be shortened individually.

1. Mark the requested length with mounted measuring rod.
2. Cable: Loosen the pins on the gravity weight (hexagon 3)
3. Cable: remove the pins
4. Cable: Pull the cable out of the gravity weight
5. Shorten the cable/rod with a cut-off wheel or metal saw at the marking. Take note of the specifications in the following illustration when shortening the cable.
6. Cable with gravity weight: Shift the cable according to the drawing into the gravity weight



7. Cable with gravity weight: Fasten cable with the pins, torque 7 Nm (5.16 lbf ft)  
Cable with centering weight: Fasten cable with the pins, torque 7 Nm (5.16 lbf ft) and fix the clamping part on the centering weight.
8. Enter new probe length and then carry out a fresh adjustment (see "Setup procedure, Carrying out min. adjustment - Carrying out max. adjustment").

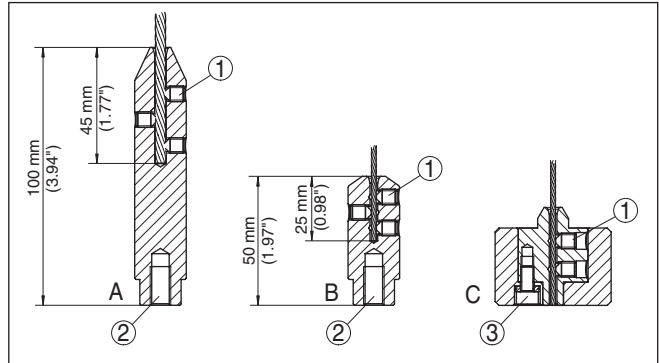

Fig. 27: Shortening the cable probe

- A Gravity weight - cable  $\varnothing$  4 mm  
 B Gravity weight - cable  $\varnothing$  2 mm  
 C Centering weight - cable  $\varnothing$  2 mm  
 1 Threaded pins  
 2 Thread M8 for eye-bolt  
 3 Fixing screw - centering weight

## 9.7 Software update

The following components are required to update the sensor software:

- Sensor
- Voltage supply
- PC with PACTware
- Current sensor software as file

You can find the actual sensor software as well as detailed information of the procedure in the download area on our homepage: [www.siemens.com/sitranslg](http://www.siemens.com/sitranslg).

You can find information about the installation in the download file.



### Caution:

Instruments with approvals can be bound to certain software versions. Therefore make sure that the approval is still effective after a software update is carried out.

You can find detailed information in the download area on our homepage: [www.siemens.com/sitranslg](http://www.siemens.com/sitranslg).

---

## 9.8 How to proceed if a repair is necessary

If it is necessary to repair the instrument, please contact Siemens. You find the locations on "[www.siemens.com/processautomation](http://www.siemens.com/processautomation)".

---

## 10 Dismount

### 10.1 Dismounting steps



**Warning:**

Before dismantling, be aware of dangerous process conditions such as e.g. pressure in the vessel or pipeline, high temperatures, corrosive or toxic media etc.

Take note of chapters "*Mounting*" and "*Connecting to voltage supply*" and carry out the listed steps in reverse order.

### 10.2 Disposal

The instrument consists of materials which can be recycled by specialised recycling companies. We use recyclable materials and have designed the electronics to be easily separable.

**WEEE directive**

The instrument does not fall in the scope of the EU WEEE directive. Article 2 of this Directive exempts electrical and electronic equipment from this requirement if it is part of another instrument that does not fall in the scope of the Directive. These include stationary industrial plants.

Pass the instrument directly on to a specialised recycling company and do not use the municipal collecting points.

If you have no way to dispose of the old instrument properly, please contact us concerning return and disposal.

---

# 11 Supplement

## 11.1 Technical data

### General data

---

316L corresponds to 1.4404 or 1.4435

#### Materials, wetted parts

- Process fitting (version up to 6 bar) 316L and PPS GF 40
- Process fitting (version up to 40 bar) 304L and PCTFE, 316L and PEEK, Alloy C22 (2.4602) and PEEK, Alloy C276 (2.4819) and PEEK, Duplex steel (1.4462) and PEEK, Alloy 400 (2.4360) and PTFE
- Process seal on the instrument side (cable/rod leadthrough) FKM (SHS FPM 70C3 GLT), FFKM (Kalrez 6375), EPDM (A+P 70.10-02), silicone FEP coated (A+P FEP-O-SEAL)
- Process seal On site (instruments with thread: Klingersil C-4400 is enclosed)
- Rod:  $\varnothing$  8 mm (0.315 in) 316L, Alloy C22 (2.4602), 304L, Alloy C276 (2.4819), Duplex steel (1.4462)
- Rod:  $\varnothing$  12 mm (0.472 in) 316L, Alloy C22 (2.4602), Alloy 400 (2.4360)
- Cable:  $\varnothing$  2 mm (0.079 in) 316 (1.4401), Alloy C276 (2.4819), Alloy 400 (2.4360)
- Cable:  $\varnothing$  4 mm (0.157 in) 316 (1.4401), Alloy C22 (2.4602), PFA
- Inner conductor (up to the cable) 316L
- Gravity weight (optionally available) 316L
- Centering weight (optionally available) 316L

#### Materials, non-wetted parts

- Plastic housing Plastic PBT (Polyester)
- Aluminium die-cast housing Aluminium die-casting AlSi10Mg, powder-coated (Basis: Polyester)
- Stainless steel housing (precision casting) 316L
- Stainless steel housing (electropolished) 316L
- Temperature adapter 316L
- Second Line of Defense (optional) Borosilicate glass GPC 540 with 316L and Alloy C22 (2.4602)
- Seal between housing and housing lid Silicone SI 850 R
- Inspection window in housing cover (optional) Plastic housing: Polycarbonate  
Metal housing: Glass
- Ground terminal 316L
- Cable gland PA, stainless steel, brass
- Sealing, cable gland NBR
- Blind plug, cable gland PA

---

## Second Line of Defense (optional)

- The Second Line of Defense (SLOD) is a second level of the process separation in the form of a gas-tight feedthrough in the lower part of the housing, preventing product from penetrating into the housing.
  - Supporting material 316L
  - Glass potting Borosilicate glass GPC 540
  - Contacts Alloy C22 (2.4602)
  - Helium leak rate  $< 10^{-6}$  mbar l/s
  - Pressure resistance See process pressure of the sensor
- Conductive connection Between ground terminal, process fitting and probe

## Process fittings

- Pipe thread, cylindrical (ISO 228 T1) G $\frac{3}{4}$ , G1, G1 $\frac{1}{2}$  (DIN 3852-A)
- Pipe thread, conical (ASME B1.20.1)  $\frac{3}{4}$  NPT, 1 NPT, 1 $\frac{1}{2}$  NPT
- Flanges DIN from DN 25, ASME from 1"

## Weight

- Instrument weight (depending on process fitting) approx. 0.8 ... 8 kg (0.176 ... 17.64 lbs)
- Rod:  $\varnothing$  8 mm (0.315 in) approx. 400 g/m (4.3 oz/ft)
- Rod:  $\varnothing$  12 mm (0.472 in) approx. 900 g/m (9.68 oz/ft)
- Cable:  $\varnothing$  2 mm (0.079 in) approx. 16 g/m (0.17 oz/ft)
- Cable:  $\varnothing$  4 mm (0.157 in) approx. 60 g/m (0.65 oz/ft)
- Gravity weight for cable  $\varnothing$  2 mm (0.079 in) 100 g (3.22 oz)
- Gravity weight for cable  $\varnothing$  4 mm (0.157 in) 200 g (6.43 oz)
- Centering weight  $\varnothing$  40 mm (1.575 in) 180 g (5.79 oz)
- Centering weight  $\varnothing$  45 mm (1.772 in) 250 g (8.04 oz)
- Centering weight  $\varnothing$  75 mm (2.953 in) 825 g (26.52 oz)
- Centering weight ( $\varnothing$  95 mm (3.74 in) 1050 g (33.76 oz)

## Probe length L (from seal surface)

- Rod:  $\varnothing$  8 mm (0.315 in) up to 6 m (19.69 ft)
- Rod:  $\varnothing$  12 mm (0.472 in) up to 6 m (19.69 ft)
- Trimming accuracy - rod  $\pm(1 \text{ mm} + 0.05 \% \text{ of the rod length})$
- Cable:  $\varnothing$  2 mm (0.079 in) up to 75 m (246.1 ft)
- Cable:  $\varnothing$  4 mm (0.157 in) up to 75 m (246 ft)
- Trimming accuracy - cable  $\pm(2 \text{ mm} + 0.05 \% \text{ of the cable length})$

## Lateral load

- Rod:  $\varnothing$  8 mm (0.315 in) 10 Nm (7.38 lbf ft)
- Rod:  $\varnothing$  12 mm (0.472 in) 30 Nm (22.13 lbf ft)

---

**Max. tensile load**

- Cable:  $\varnothing$  2 mm (0.079 in) - 316      1.5 KN (337 lbf)  
(1.4401)
- Cable:  $\varnothing$  2 mm (0.079 in) - Alloy C276    1.0 KN (225 lbf)  
(2.4819)
- Cable:  $\varnothing$  2 mm (0.079 in) - Alloy 400    0.6 KN (135 lbf)  
(2.4360)
- Cable:  $\varnothing$  4 mm (0.157 in)                  2.5 KN (562 lbf)

Thread in gravity weight, e.g. for eye-bolt    M 8  
(cable version)

**Torque for exchangeable cable or rod probe (in the process fitting)**

- Cable:  $\varnothing$  2 mm (0.079 in)                  6 Nm (4.43 lbf ft)
- Cable:  $\varnothing$  4 mm (0.157 in)                  6 Nm (4.43 lbf ft)
- Rod:  $\varnothing$  8 mm (0.315 in)                    6 Nm (4.43 lbf ft)
- Rod:  $\varnothing$  12 mm (0.472 in)                  10 Nm (7.38 lbf ft)

**Torque for NPT cable glands and Conduit tubes**

- Plastic housing                                  max. 10 Nm (7.376 lbf ft)
- Aluminium/Stainless steel housing        max. 50 Nm (36.88 lbf ft)

---

**Input variable**

Measured variable                                  Level of liquids

**Min. dielectric constant of the medium**

- Cable probes                                     $\epsilon_r \geq 1.6$
- Rod probes                                       $\epsilon_r \geq 1.6$

---

**Output variable**

Output signal                                        digital output signal, Profibus protocol

Transmission rate                                31.25 Kbit/s

Sensor address                                    126 (default setting)

Damping (63 % of the input variable)      0 ... 999 s, adjustable

Profibus PA profile                              3.02

Number of FBs with AI (function blocks  
with analogue input)                            3

**Default values**

- 1. FB    Primary Value (filling height linearized in %)
- 2. FB    Secondary Value 1 (filling height in %)
- 3. FB    Secondary Value 2 (distance value)

**Current value**

- Non-Ex and Ex ia instrument              10 mA,  $\pm 0.5$  mA
- Ex-d-ia instruments                          16 mA,  $\pm 0.5$  mA

Resolution, digital                                < 1 mm (0.039 in)

## Measurement accuracy (according to DIN EN 60770-1)

Process reference conditions according to DIN EN 61298-1

- Temperature +18 ... +30 °C (+64 ... +86 °F)
- Relative humidity 45 ... 75 %
- Air pressure +860 ... +1060 mbar/+86 ... +106 kPa  
(+12.5 ... +15.4 psig)

Mounting, reference conditions

- Min. distance to internal installations > 500 mm (19.69 in)
- Vessel metallic,  $\varnothing$  1 m (3.281 ft), centric mounting, process fitting flush with the vessel ceiling
- Medium Water/Oil (dielectric constant  $\sim 2.0$ )<sup>1)</sup>
- Mounting Probe end does not touch the vessel bottom

Sensor parameter adjustment

No gating out of false signals carried out

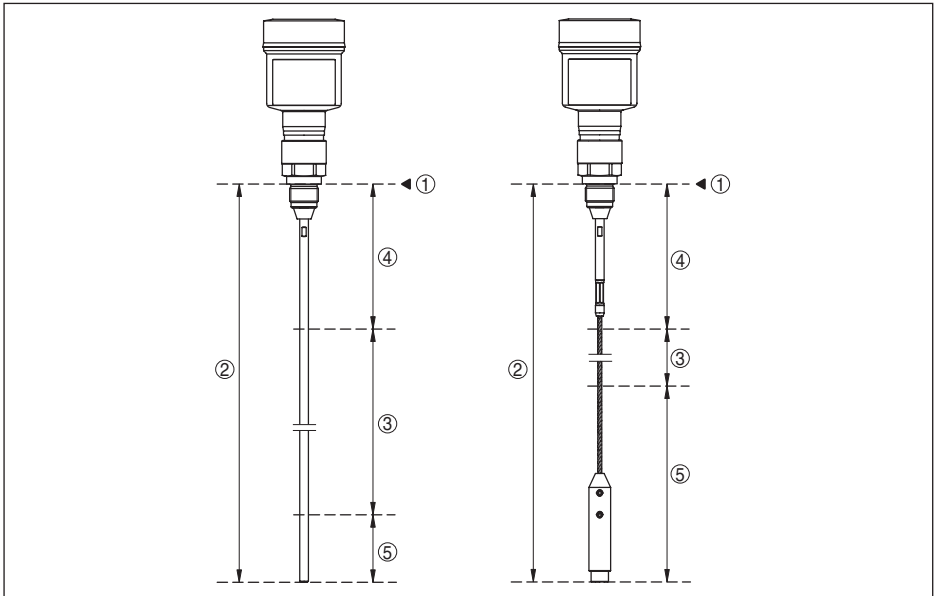

Fig. 28: Measuring ranges - SITRANS LG250

- 1 Reference plane
- 2 Probe length  $L$
- 3 Measuring range (default setting refers to the measuring range in water)
- 4 Upper dead zone (see following diagrams - grey section)
- 5 Lower dead zone (see following diagrams - grey section)

Typical deviation - Interface measurement  $\pm 5$  mm (0.197 in)

<sup>1)</sup> With interface measurement = 2.0.

Typical deviation - Total level interface measurement See following diagrams

Typical deviation - Level measurement<sup>(2)(3)</sup> See following diagrams

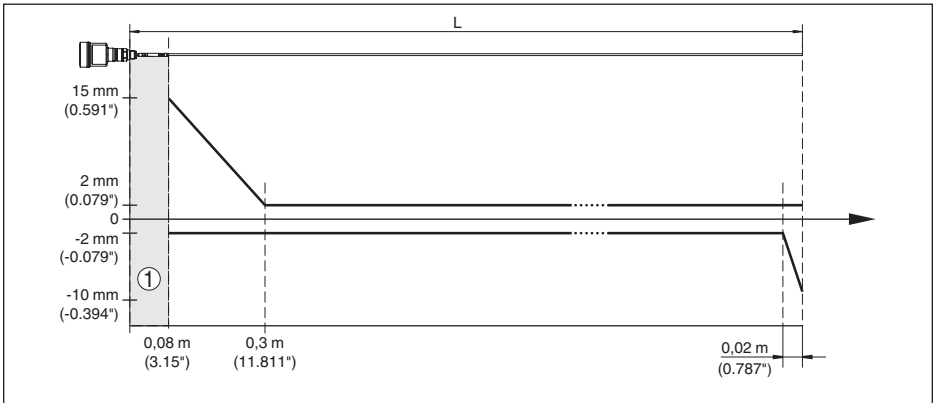

Fig. 29: Deviation SITRANS LG250 in rod version in water

- 1 Dead zone (no measurement possible in this area)
- L Probe length

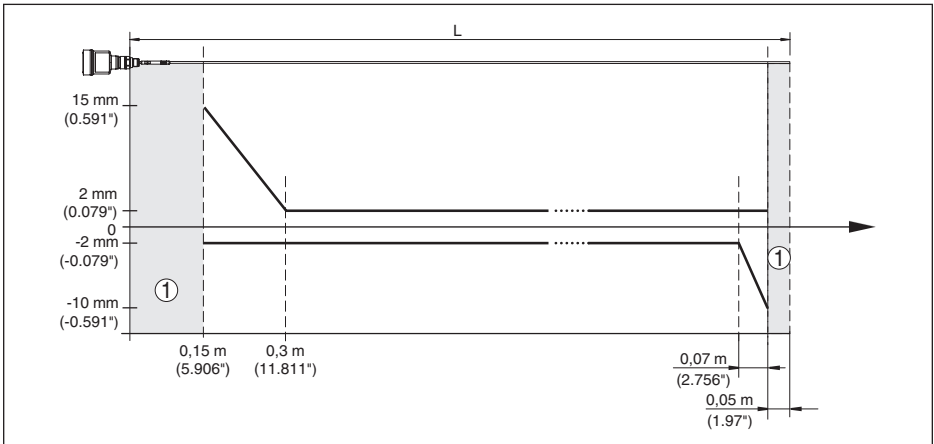

Fig. 30: Deviation SITRANS LG250 in rod version in oil

- 1 Dead zone (no measurement possible in this area)
- L Probe length

<sup>2)</sup> Depending on the mounting conditions, deviations can occur which can be rectified by adapting the adjustment or changing the measured value offset in the DTM service mode.

<sup>3)</sup> The dead zones can be optimized via a false signal suppression.



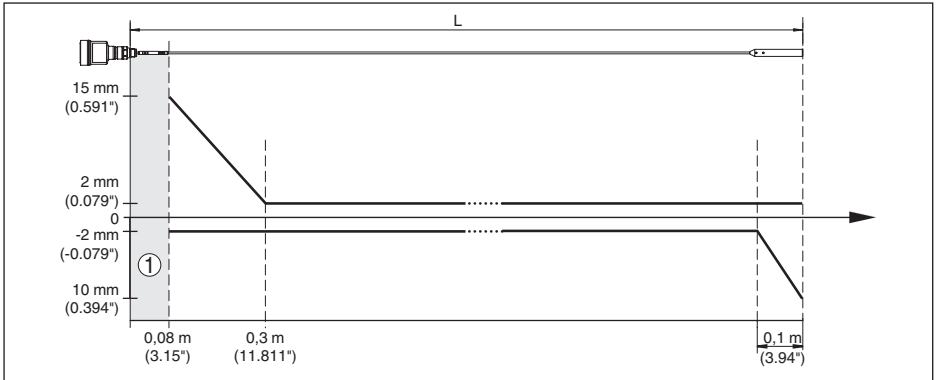

Fig. 31: Deviation SITRANS LG250 in cable version in water

1 Dead zone (no measurement possible in this area)

When using a centering weight, it is only possible to measure up to the upper edge of the centering weight.

L Probe length

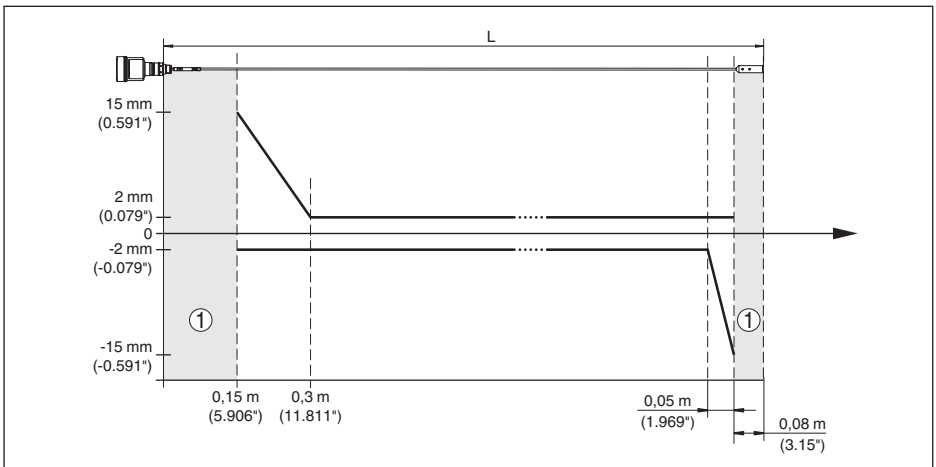

Fig. 32: Deviation SITRANS LG250 in cable version ( $\varnothing$  2 mm/0.079 in), in medium oil

1 Dead zone (no measurement possible in this area)

When using a centering weight, it is only possible to measure up to the upper edge of the centering weight.

L Probe length

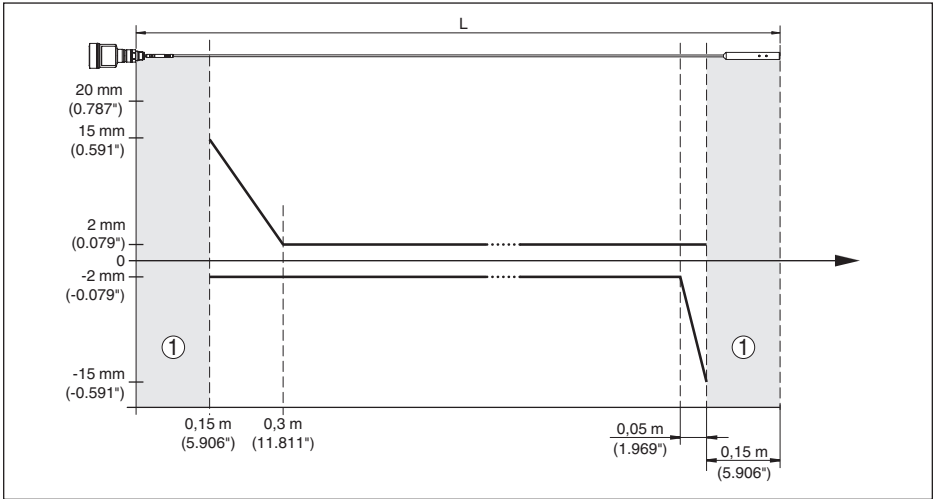

Fig. 33: Deviation SITRANS LG250 in cable version ( $\varnothing$  4 mm/0.157 in), in medium oil

1 Dead zone (no measurement possible in this area)

When using a centering weight, it is only possible to measure up to the upper edge of the centering weight.

L Probe length

Deviation (cable - PFA-coated)

from 6 m probe length = 0.5 % of the probe length

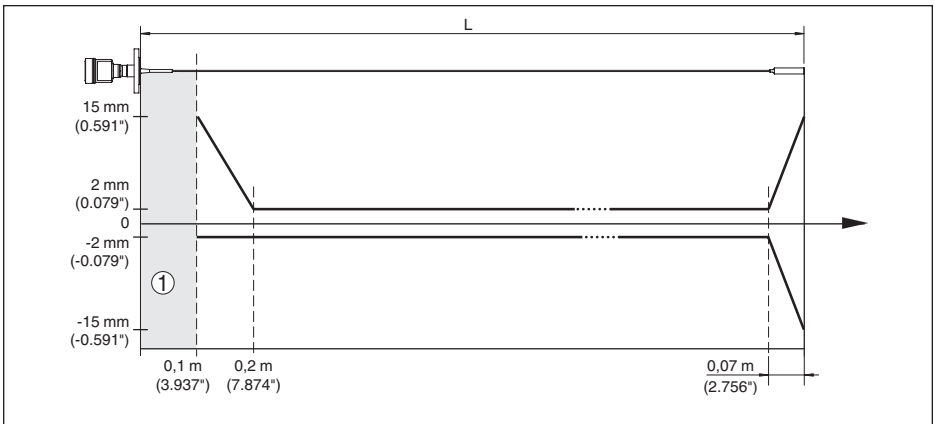

Fig. 34: Deviation SITRANS LG250 in cable version ( $\varnothing$  4 mm/0.157 in, PFA-coated) in water

1 Dead zone (no measurement possible in this area)

L Probe length

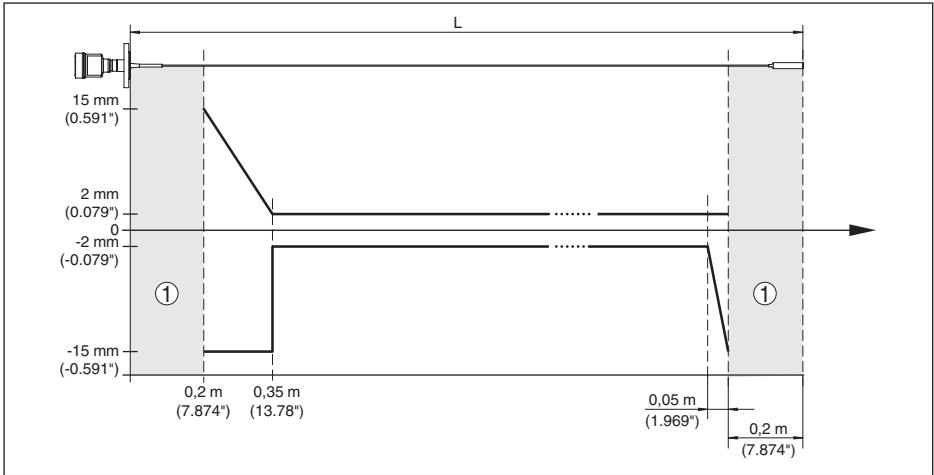

Fig. 35: Deviation SITRANS LG250 in cable version ( $\varnothing$  4 mm/0.157 in, PFA-coated), in oil

1 Dead zone (no measurement possible in this area)

L Probe length

Non-repeatability  $\leq \pm 1$  mm

### Variables influencing measurement accuracy

Temperature drift - Digital output  $\pm 3$  mm/10 K relating to the max. measuring range or max. 10 mm (0.394 in)

Additional deviation through electromagnetic interference acc. to EN 61326  $< \pm 10$  mm ( $< \pm 0.394$  in)

### Influence of the superimposed gas and pressure on measurement accuracy

The propagation speed of the radar impulses in gas or vapour above the medium is reduced by high pressure. This effect depends on the superimposed gas or vapours.

The following table shows the resulting deviation for some typical gases and vapours. The specified values refer to the distance. Positive values mean that the measured distance is too large, negative values that the measured distance is too small.

Gas phase	Temperature	Pressure		
		1 bar (14.5 psig)	10 bar (145 psig)	50 bar (725 psig)
Air	20 °C (68 °F)	0 %	0.22 %	1.2 %
	200 °C (392 °F)	-0.01 %	0.13 %	0.74 %
	400 °C (752 °F)	-0.02 %	0.08 %	0.52 %
Hydrogen	20 °C (68 °F)	-0.01 %	0.1 %	0.61 %
	200 °C (392 °F)	-0.02 %	0.05 %	0.37 %
	400 °C (752 °F)	-0.02 %	0.03 %	0.25 %

Gas phase	Temperature	Pressure		
		1 bar (14.5 psig)	10 bar (145 psig)	50 bar (725 psig)
Steam (saturated steam)	100 °C (212 °F)	0.26 %	-	-
	180 °C (356 °F)	0.17 %	2.1 %	-
	264 °C (507 °F)	0.12 %	1.44 %	9.2 %
	366 °C (691 °F)	0.07 %	1.01 %	5.7 %

### Characteristics and performance data

Measuring cycle time	< 500 ms
Step response time <sup>4)</sup>	≤ 3 s
Max. filling/emptying speed	1 m/min Products with high dielectric constant (>10) up to 5 m/min.

### Ambient conditions

Ambient, storage and transport temperature

- Standard -40 ... +80 °C (-40 ... +176 °F)
- CSA, Ordinary Location -40 ... +60 °C (-40 ... +140 °F)

### Process conditions

For the process conditions, please also note the specifications on the type label. The lowest value always applies.

The measurement error through the process conditions in the specified pressure and temperature range is < 1 %.

Process pressure

- Process fitting with PPS GF 40 -1 ... 6 bar/-100 ... 600 kPa (-14.5 ... 87 psi), depending on the process fitting
- Process fitting with PEEK -1 ... +40 bar/-100 ... +4000 kPa (-14.5 ... +580 psig), depending on the process fitting

Vessel pressure relating to the flange nominal pressure stage

see supplementary instructions manual "*Flanges according to DIN-EN-ASME-JIS*"

Process temperature (thread or flange temperature)

- PPS GF 40 -40 ... +80 °C (-40 ... +176 °F)
- FKM (SHS FPM 70C3 GLT) -40 ... +150 °C (-40 ... +302 °F)
- EPDM (A+P 70.10-02) -40 ... +150 °C (-40 ... +302 °F)
- Silicone FEP coated (A+P FEP-O-SEAL) -40 ... +150 °C (-40 ... +302 °F)
- FFKM (Kalrez 6375) -20 ... +150 °C (-4 ... +302 °F)
- FFKM (Kalrez 6375) - with temperature adapter -20 ... +200 °C (-4 ... +392 °F)

<sup>4)</sup> Time span after a sudden measuring distance change by max. 0.5 m in liquid applications, max 2 m with bulk solids applications, until the output signal has taken for the first time 90 % of the final value (IEC 61298-2).

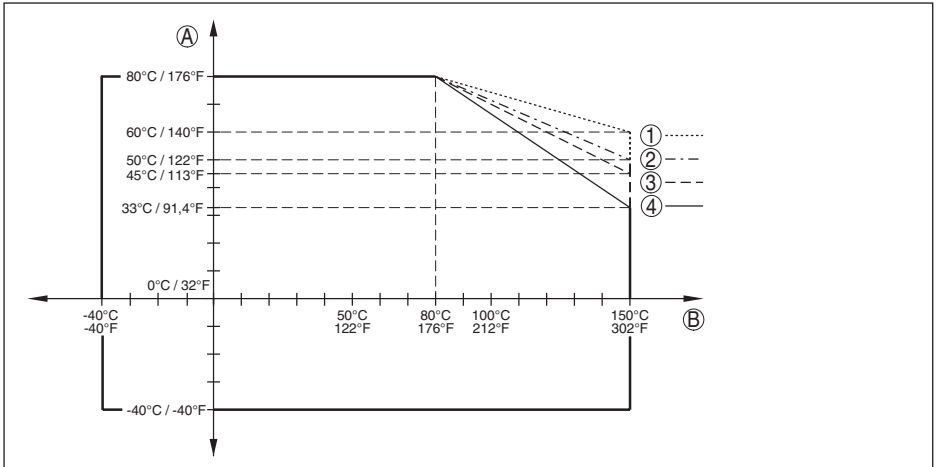

Fig. 36: Ambient temperature - process temperature, standard version

- A Ambient temperature
- B Process temperature (depending on the seal material)
- 1 Aluminium housing
- 2 Plastic housing
- 3 Stainless steel housing, precision casting
- 4 Stainless steel housing, electropolished

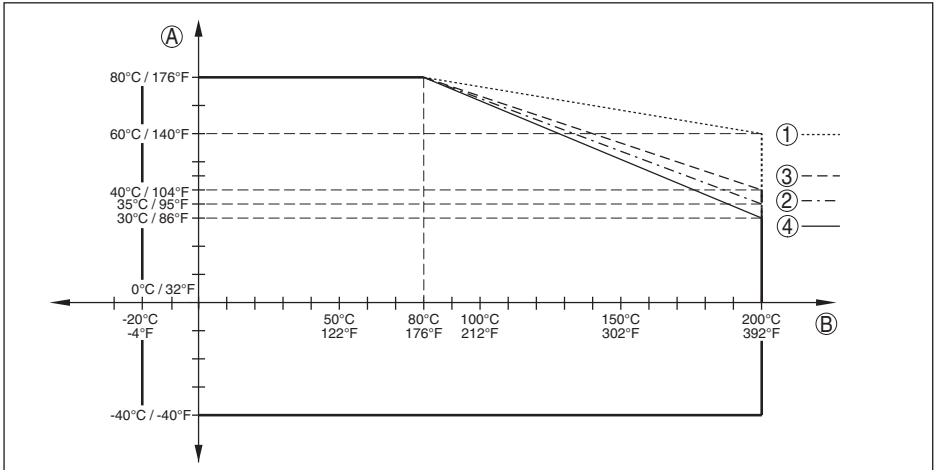

Fig. 37: Ambient temperature - process temperature, version with temperature adapter

- A Ambient temperature
- B Process temperature (depending on the seal material)
- 1 Aluminium housing
- 2 Plastic housing
- 3 Stainless steel housing, precision casting
- 4 Stainless steel housing, electropolished

Vibration resistance

- Rod probe 1 g with 5 ... 200 Hz according EN 60068-2-6 (vibration at resonance) with rod length 50 cm (19.69 in)

Shock resistance

- Rod probe 25 g, 6 ms according to EN 60068-2-27 (mechanical shock) with rod length 50 cm (19.69 in)

---

**Electromechanical data - version IP66/IP67 and IP66/IP68 (0.2 bar)**

---

Options of the cable entry

- Cable entry M20 x 1.5; ½ NPT
- Cable gland M20 x 1.5; ½ NPT (cable ø see below table)
- Blind plug M20 x 1.5; ½ NPT
- Closing cap ½ NPT

Material cable gland	Material seal insert	Cable diameter				
		4.5 ... 8.5 mm	5 ... 9 mm	6 ... 12 mm	7 ... 12 mm	10 ... 14 mm
PA	NBR	–	●	●	–	●
Brass, nickel-plated	NBR	●	●	●	–	–
Stainless steel	NBR	–	●	●	–	●

Wire cross-section (spring-loaded terminals)

- Massive wire, stranded wire 0.2 ... 2.5 mm<sup>2</sup> (AWG 24 ... 14)
- Stranded wire with end sleeve 0.2 ... 1.5 mm<sup>2</sup> (AWG 24 ... 16)

---

**Electromechanical data - version IP66/IP68 (1 bar)**

---

Options of the cable entry

- Cable gland with integrated connection cable M20 x 1.5 (cable ø 5 ... 9 mm)
- Cable entry ½ NPT
- Blind plug M20 x 1.5; ½ NPT

Connection cable

- Wire cross-section 0.5 mm<sup>2</sup> (AWG 20)
- Wire resistance < 0.036 Ω/m
- Tensile strength < 1200 N (270 lbf)
- Standard length 5 m (16.4 ft)
- Max. length 180 m (590.6 ft)
- Min. bending radius (at 25 °C/77 °F) 25 mm (0.984 in)
- Diameter approx. 8 mm (0.315 in)
- Colour - Non-Ex version Black
- Colour - Ex-version Blue

---

---

### Integrated clock

---

Date format	Day.Month.Year
Time format	12 h/24 h
Time zone, factory setting	CET
Max. rate deviation	10.5 min/year

---

### Additional output parameter - Electronics temperature

---

Range	-40 ... +85 °C (-40 ... +185 °F)
Resolution	< 0.1 K
Deviation	±3 K
Output of the temperature values	
– Indication	Via the display and adjustment module
– Output	Via the respective output signal

---

### Voltage supply

---

Operating voltage $U_B$	9 ... 32 V DC
Operating voltage - with Bluetooth switched on	11.6 ... 32 V DC
Operating voltage $U_B$ with lighting switched on	13.5 ... 32 V DC
Number of sensors per DP/PA segment coupler, max.	32

---

### Potential connections and electrical separating measures in the instrument

---

Electronics	Not non-floating
Reference voltage <sup>5)</sup>	500 V AC
Conductive connection	Between ground terminal and metallic process fitting

---

### Electrical protective measures

---

Protection rating

Housing material	Version	Protection acc. to IEC 60529	Protection acc. to NEMA
Plastic	Single chamber	IP66/IP67	Type 4X
	Double chamber	IP66/IP67	Type 4X
Aluminium	Single chamber	IP66/IP68 (0.2 bar)	Type 6P
	Double chamber	IP66/IP67 IP66/IP68 (0.2 bar)	Type 4X Type 6P
Stainless steel, electro-polished	Single chamber	IP66/IP68 (0.2 bar)	Type 6P
Stainless steel, precision casting	Single chamber	IP66/IP68 (0.2 bar)	Type 6P
	Double chamber	IP66/IP67 IP66/IP68 (0.2 bar)	Type 4X Type 6P

<sup>5)</sup> Galvanic separation between electronics and metal housing parts

---

Connection of the feeding power supply unit Networks of overvoltage category III

Altitude above sea level

- by default up to 2000 m (6562 ft)
- with connected overvoltage protection up to 5000 m (16404 ft)

Pollution degree<sup>6)</sup> 4

Protection class III<sup>7)</sup>

## 11.2 Device communication Profibus PA

In the following, the necessary device-specific details are shown. You can find further information of Profibus PA on [www.profibus.com](http://www.profibus.com).

### Instrument master file

The instrument master file (GSD) contains the characteristic data of the Profibus PA instrument. These data are, e.g. the permissible transmission rates as well as information on diagnostics values and the format of the measured value output by the PA instrument.

A bitmap file is also provided for the Profibus network planning tool. This file is installed automatically when the GSD file is integrated. The bitmap file is used for symbolic indication of the PA instrument in the configuration tool.

### ID number

Each Profibus instrument gets an unambiguous ident number (ID number) from the Profibus user organisation (PNO). This ID number is also included in the name of the GSD file. Optionally in addition to this manufacturer-specific GSD file, PNO also provides a general so-called profile-specific GSD file. If the general GSD file is used, the sensor must be set to the profile-specific ident number via the DTM software. By default, the sensor operates with the manufacturer-specific ID number. When using the instruments on a segment coupler SK-2 or SK-3, no special GSD files are required.

SI0181B9

The following table shows the instrument ID and the GSD names for the SITRANS LG sensor series.

Device name	Instrument ID		GSD file name	
	Siemens	Instrument class in profile 3.02	Siemens	Profile-specific
SITRANS series LG	0x81B9	0x9702	SI0181B9.GSD	PA139702.GSD

### Cyclical data traffic

The master class 1 (e.g. PLC) cyclically reads out measured values from the sensor during operation. The below block diagram below shows which data can be accessed by the PLC.

<sup>6)</sup> When used with fulfilled housing protection

<sup>7)</sup> IEC 61010-1



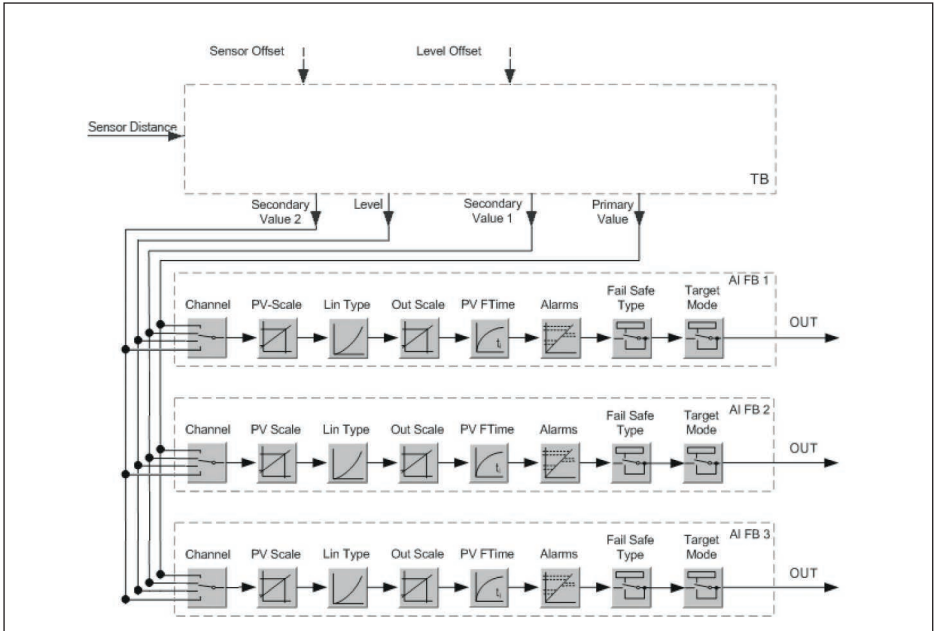

Fig. 38: SITRANS LG250: Block diagram with AI FB 1 ... AI FB 3 OUT values

TB Transducer Block

FB 1 ... FB 3

Function Block

## Module of the PA sensors

For the cyclic data traffic, SITRANS LG250 provides the following modules:

- AI FB1 (OUT)
  - Out value of the AI FB1 after scaling
- AI FB2 (OUT)
  - Out value of the AI FB2 after scaling
- AI FB3 (OUT)
  - Out value of the AI FB3 after scaling
- Free Place
  - This module must be used if a value in the data telegram of the cyclical data traffic should not be used (e.g. replacement of temperature and Additional Cyclic Value)

A maximum of three modules can be active. By means of the configuration software of the Profibus master you can determine the configuration of the cyclical data telegram with these modules. The procedure depends on the respective configuration software.



### Note:

The modules are available in two versions:

- Short for Profibus master supporting only one "Identifier Format" byte, e.g. Allen Bradley
- Long for Profibus master only supporting the "Identifier Format" byte, e.g. Siemens S7-300/400

## Examples of telegram configuration

In the following you will see how the modules can be combined and how the appendant data telegram is structured.

### Example 1

- AI FB1 (OUT)
- AI FB2 (OUT)
- AI FB3 (OUT)

Byte-No.	1	2	3	4	5	6	7	8	9	10	11	12	13	14	15
Format	IEEE-754-Floating point value				Status	IEEE-754-Floating point value				Status	IEEE-754-Floating point value				Status
Value	AI FB1 (OUT)				AI FB1	AI FB2 (OUT)				AI FB2	AI FB3 (OUT)				AI FB3

### Example 2

- AI FB1 (OUT)
- Free Place
- Free Place

Byte-No.	1	2	3	4	5
Format	IEEE-754-Floating point value				Status
Value	AI FB1 (OUT)				AI FB1



#### Note:

Bytes 6-15 are not used in this example.

## Data format of the output signal

Byte4	Byte3	Byte2	Byte1	Byte0
Status	Value (IEEE-754)			

Fig. 39: Data format of the output signal

The status byte corresponds to profile 3.02 "Profibus PA Profile for Process Control Devices" coded. The status "Measured value OK" is coded as 80 (hex) (Bit7 = 1, Bit6 ... 0 = 0).

The measured value is transferred as a 32 bit floating point number in the IEEE-754 format.

Byte n								Byte n+1								Byte n+2								Byte n+3							
Bit 7	Bit 6	Bit 5	Bit 4	Bit 3	Bit 2	Bit 1	Bit 0	Bit 7	Bit 6	Bit 5	Bit 4	Bit 3	Bit 2	Bit 1	Bit 0	Bit 7	Bit 6	Bit 5	Bit 4	Bit 3	Bit 2	Bit 1	Bit 0	Bit 7	Bit 6	Bit 5	Bit 4	Bit 3	Bit 2	Bit 1	Bit 0
VZ	2 <sup>7</sup>	2 <sup>6</sup>	2 <sup>5</sup>	2 <sup>4</sup>	2 <sup>3</sup>	2 <sup>2</sup>	2 <sup>1</sup>	2 <sup>0</sup>	2 <sup>1</sup>	2 <sup>2</sup>	2 <sup>3</sup>	2 <sup>4</sup>	2 <sup>5</sup>	2 <sup>6</sup>	2 <sup>7</sup>	2 <sup>-8</sup>	2 <sup>-9</sup>	2 <sup>-10</sup>	2 <sup>-11</sup>	2 <sup>-12</sup>	2 <sup>-13</sup>	2 <sup>-14</sup>	2 <sup>-15</sup>	2 <sup>-16</sup>	2 <sup>-17</sup>	2 <sup>-18</sup>	2 <sup>-19</sup>	2 <sup>-20</sup>	2 <sup>-21</sup>	2 <sup>-22</sup>	2 <sup>-23</sup>
Sign Bit	Exponent							Significant							Significant							Significant									

$$\text{Value} = (-1)^{VZ} \cdot 2^{(\text{Exponent} - 127)} \cdot (1 + \text{Significant})$$

Fig. 40: Data format of the measured value

## Coding of the status byte associated with the PA output value

You can find further information for the coding of the status byte in the Device Description 3.02 on [www.profibus.com](http://www.profibus.com).

Status code	Description according to Profibus standard	Possible cause
0 x 00	bad - non-specific	Flash-Update active
0 x 04	bad - configuration error	<ul style="list-style-type: none"> <li>● Adjustment error</li> <li>● Configuration error with PV-Scale (PV-Span too small)</li> <li>● Unit irregularity</li> <li>● Error in the linearization table</li> </ul>
0 x 0C	bad - sensor failure	<ul style="list-style-type: none"> <li>● Hardware error</li> <li>● Converter error</li> <li>● Leakage pulse error</li> <li>● Trigger error</li> </ul>
0 x 10	bad - sensor failure	<ul style="list-style-type: none"> <li>● Measured value generation error</li> <li>● Temperature measurement error</li> </ul>
0 x 1f	bad - out of service constant	"Out of Service" mode switched on
0 x 44	uncertain - last unstable value	Failsafe replacement value (Failsafe-Mode = "Last value" and already valid measured value since switching on)
0 x 48	uncertain substitute set	<ul style="list-style-type: none"> <li>● Switch on simulation</li> <li>● Failsafe replacement value (Failsafe-Mode = "Fsafe value")</li> </ul>
0 x 4c	uncertain - initial value	Failsafe replacement value (Failsafe-Mode = "Last valid value" and no valid measured value since switching on)
0 x 51	uncertain - sensor; conversion not accurate - low limited	Sensor value < lower limit
0 x 52	uncertain - sensor; conversion not accurate - high limited	Sensor value > upper limit
0 x 80	good (non-cascade) - OK	OK
0 x 84	good (non-cascade) - active block alarm	Static revision (FB, TB) changed (10 sec. active, after the parameter of the static category has been written)
0 x 89	good (non-cascade) - active advisory alarm - low limited	Lo-Alarm
0 x 8a	good (non-cascade) - active advisory alarm - high limited	Hi-Alarm
0 x 8d	good (non-cascade) - active critical alarm - low limited	Lo-Lo-Alarm
0 x 8e	good (non-cascade) - active critical alarm - high limited	Hi-Hi-Alarm

## 11.3 Dimensions

### Plastic housing

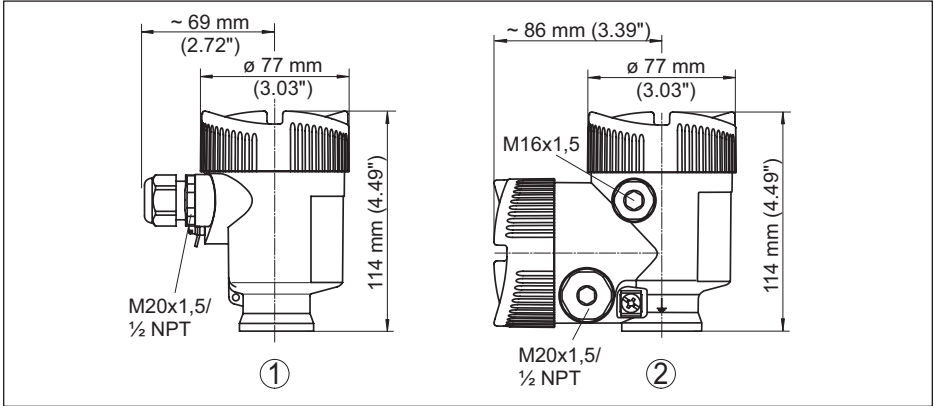

Fig. 41: Housing versions in protection IP66/IP67 (with integrated display and adjustment module the housing is 9 mm/0.35 in higher)

- 1 Plastic single chamber
- 2 Plastic double chamber

### Aluminium housing

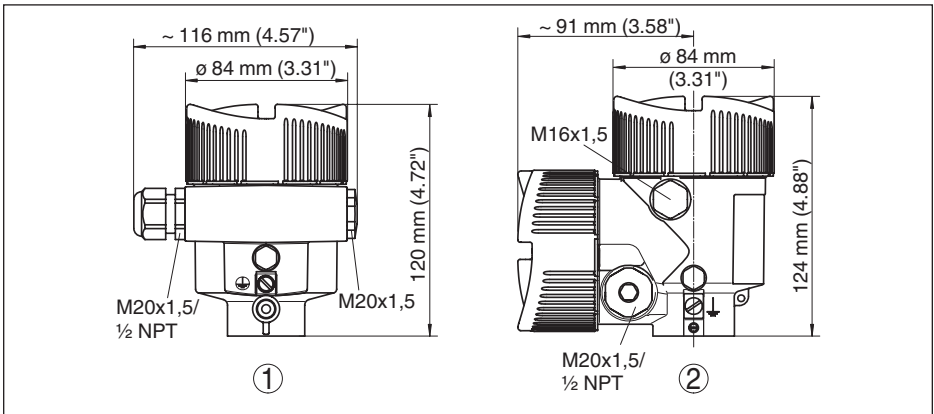

Fig. 42: Housing versions with protection rating IP66/IP68 (0.2 bar), (with integrated display and adjustment module the housing is 9 mm/0.35 in higher)

- 1 Aluminium - single chamber
- 2 Aluminium - double chamber

## Stainless steel housing

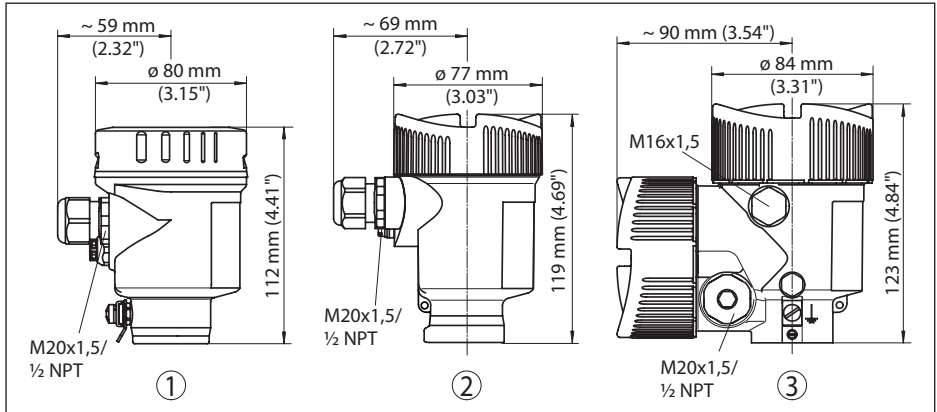

Fig. 43: Housing versions with protection rating IP66/IP68 (0.2 bar), (with integrated display and adjustment module the housing is 9 mm/0.35 in higher)

- 1 Stainless steel single chamber (electropolished)
- 2 Stainless steel single chamber (precision casting)
- 3 Stainless steel double chamber housing (precision casting)

## SITRANS LG250, cable version with gravity weight

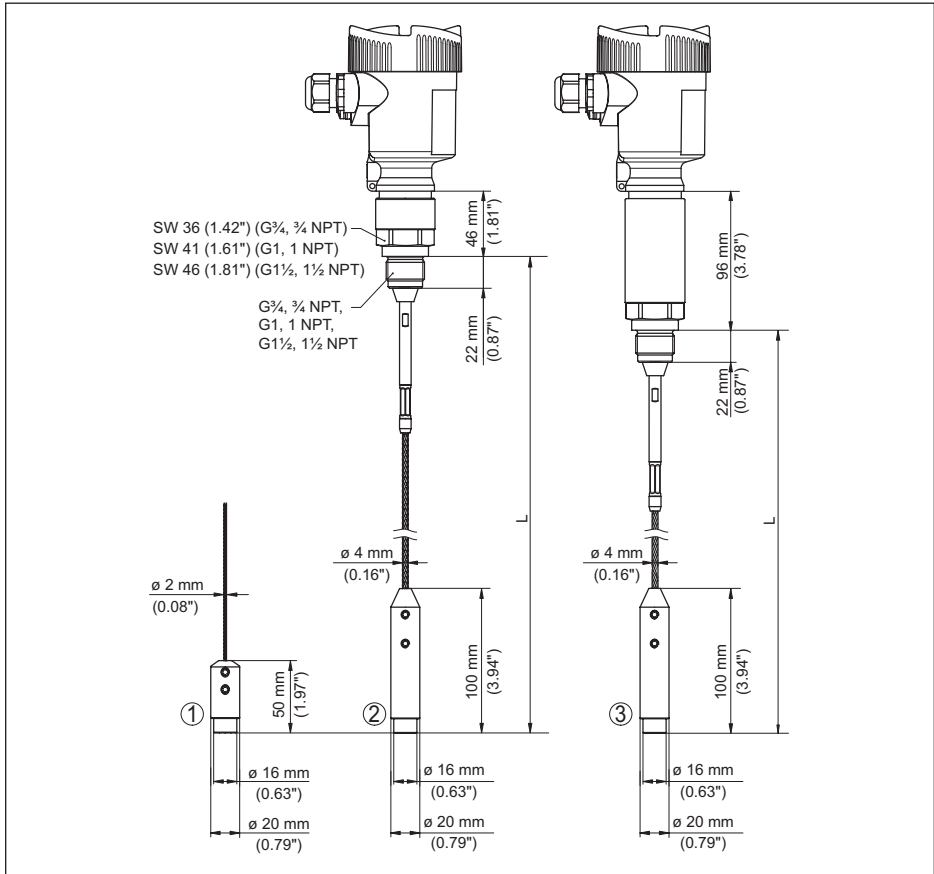

Fig. 44: SITRANS LG250, threaded version with gravity weight (all gravity weights with thread M8 for eye-bolt)

L Sensor length, see chapter "Technical data"

- 1 Cable version  $\varnothing$  2 mm (0.079 in) with gravity weight
- 2 Cable version  $\varnothing$  4 mm (0.157 in) with gravity weight
- 3 Cable version with temperature adapter

## SITRANS LG250, cable version with centering weight

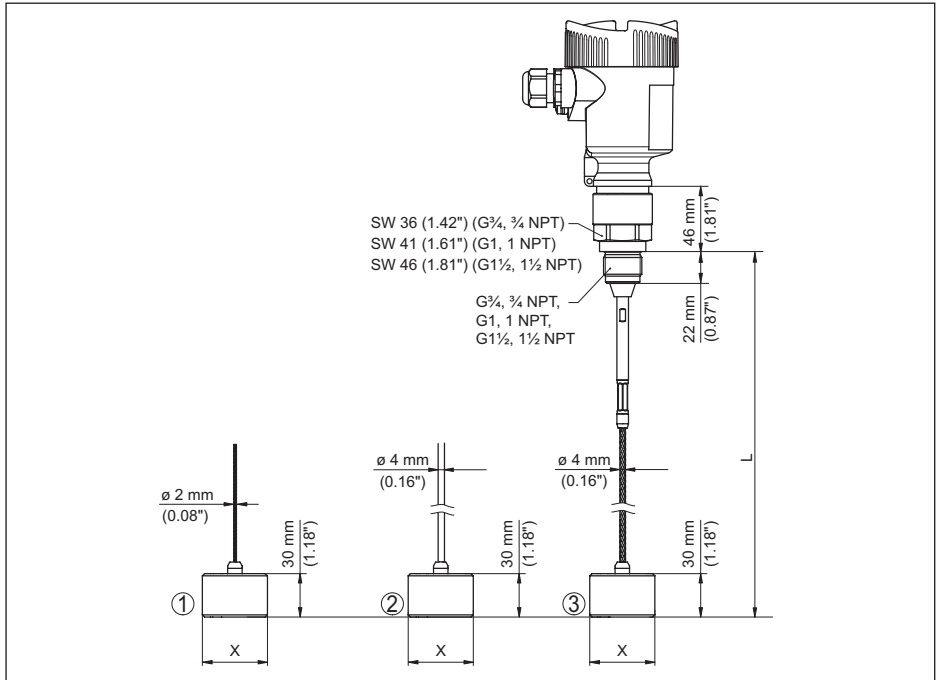

Fig. 45: SITRANS LG250, threaded version

L Sensor length, see chapter "Technical data"

x  $\varnothing$  40 mm (1.57 in)

$\varnothing$  45 mm (1.77 in)

$\varnothing$  75 mm (2.95 in)

$\varnothing$  95 mm (3.74 in)

1 Cable version  $\varnothing$  2 mm (0.079 in) with centering weight (see supplementary instructions "Centering")

2 Cable version  $\varnothing$  4 mm (0.157 in) PFA-coated with centering weight (see supplementary instructions "Centering")

3 Cable version  $\varnothing$  4 mm (0.157 in) with centering weight (see supplementary instructions "Centering")

**SITRANS LG250, rod version**

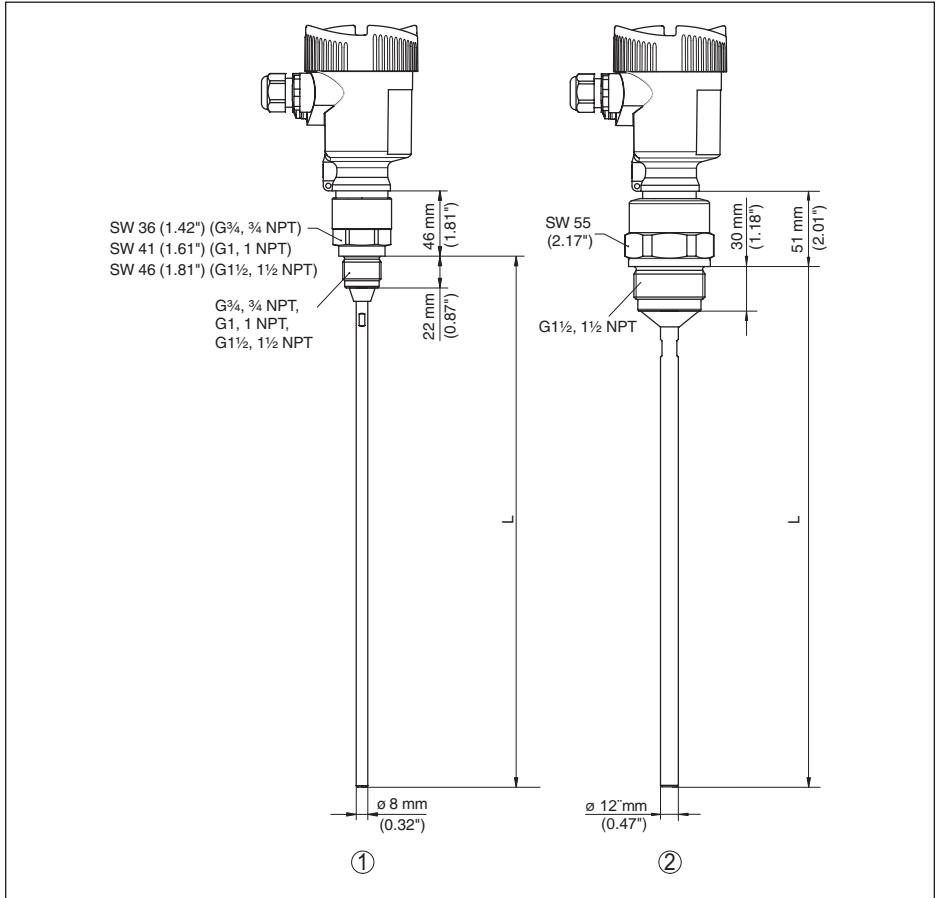

Fig. 46: SITRANS LG250, threaded version

L Sensor length, see chapter "Technical data"

1 Rod version  $\varnothing 8 \text{ mm}$  (0.315 in)

2 Rod version  $\varnothing 12 \text{ mm}$  (0.472 in)



---

## 11.4 Trademark

All the brands as well as trade and company names used are property of their lawful proprietor/originator.

---

# INDEX

## A

- Accessories
  - Display and adjustment module 12
  - External display and adjustment unit 12
- Adjustment
  - Max. adjustment 33, 34
  - Min. adjustment 33, 34
- Adjustment system 28
- AI FB1 Function Block 37
- Application 32, 33
- Application area 9

## B

- Backlight 39

## C

- Channel 37
- Connecting
  - To the PC 49
- Copy sensor settings 46
- Curve display
  - Echo curve 41
- Cyclical data traffic 80

## D

- Damping 37
- Data format, output signal 82
- Date of manufacture 47
- Date/Time 42
- Default values 43
- Deviation 59, 61
- Display format 39

## E

- Echo curve memory 55
- Echo curve of the setup 41
- EDD (Enhanced Device Description) 53
- Electrical connection 23
- Error codes 57
- Event memory 54

## F

- Factory calibration date 47
- False signal suppression 34
- Fault
  - Rectification 58
- Fault rectification 58
- Functional principle 9

## G

- Gas phase 32
- GSD file 80

## H

- Hardware addressing 26, 30

## I

- Inflowing medium 16
- Installation position 14
- Instrument address 25, 30
- Instrument master file 80

## K

- Key function 28

## L

- Language 38
- Linearisation 35
- Lock adjustment 38

## M

- Main menu 29
- Measured value indication 38, 39
- Measured value memory 54
- Measurement loop name 31
- Measurement reliability 40

## N

- NAMUR NE 107 55
  - Failure 56
  - Maintenance 58
  - Out of specification 57

## P

- PA modules 81
- Peak value indicator 39, 40
- Probe length 31
- Probe type 47
- Profibus Ident Number 47

## Q

- Quick setup 29

## R

- Read out info 47
- Repair 66
- Replacement parts
  - Rod components 12
  - Spacer 12

---

Reset 42

## **S**

Scaling 37

Scaling unit 37

Sensor characteristics 47

Sensor status 39

Simulation 41

Software addressing 26, 31

Special parameters 47

Status bytes PA output value 83

## **T**

Telegram configuration 82

Type label 8

Type of medium 32

## **U**

Units 31

## For more information

[www.siemens.com/level](http://www.siemens.com/level)

[www.siemens.com/weighing](http://www.siemens.com/weighing)



Siemens Canada Limited  
PD PA PI LW  
1954 Technology Drive  
P.O. Box 4225  
Peterborough, ON  
K9J 7B1, Canada

email: [techpubs.smpi@siemens.com](mailto:techpubs.smpi@siemens.com)

[www.siemens.com/processautomation](http://www.siemens.com/processautomation)

Subject to change without prior notice  
PBD-51041053 Rev. 7.0

© Siemens AG 2020



**PBD-51041053**

Printed in Canada