

Datasheet

Radar-Based Sensors for Detection of Moving and Stationary Targets

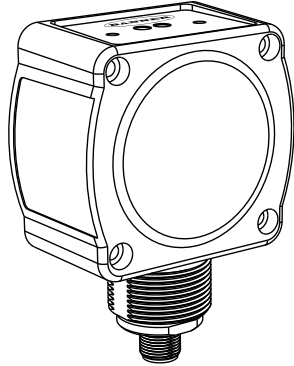

- FMCW (true-presence) radar detects moving and stationary objects
- Higher sensitivity and longer range
- Adjustable sensing field — ignores objects beyond setpoint
- Easy setup and configuration of range, sensitivity, and output with simple DIP switches
- Sensing functions are unaffected by wind, falling rain or snow, fog, humidity, air temperatures, or light
- Sensor operates in Industrial, Scientific, and Medical (ISM) telecommunication band
- Rugged IP67 housing withstands harsh environments

Protected by US patents



CAUTION: Make No **Modifications** to this Product

Any modifications to this product not expressly approved by Banner Engineering could void the user's authority to operate the product. Contact Banner Engineering for more **information**.



WARNING: Not To Be Used for Personnel **Protection**

Never use this device as a sensing device for personnel **protection**. Doing so could lead to serious injury or death. This device does not include the self-checking redundant circuitry necessary to allow its use in personnel safety applications. A sensor failure or malfunction can cause either an energized or de-energized sensor output condition.

Models

Models ¹	Maximum Range	Connection	Supply Voltage	Telecom Approval ²	Output
QT50R-US-AFH	24 m (78 ft)	5-wire 2 m (6.5 ft) Integral cable	12 to 30 V dc	Telecom approved for US, Canada and Brazil	Bipolar NPN/PNP DIP-switch-selectable N.O. or N.C.
QT50R-EU-AFH				Telecom approved for Europe, UK, Australia, New Zealand, China, and Japan	
QT50R-KR-AFH			12 to 24 V dc	Telecom approved for South Korea	
QT50R-TW-AFH			12 to 30 V dc	Telecom approved for Taiwan	
QT50R-SG-AFH				Telecom approved for Singapore	

¹ Cabled models only are listed. For integral 5-pin Euro-style (M12) quick-disconnect fitting, add suffix "Q" to the model number (e.g., QT50R-xx-AFHQ). QD models require a mating cordset; see [Quick Disconnect \(QD\) Cordsets](#) on page 6.

² For additional countries, contact Banner Engineering.



Overview

The R-GAGE sensor emits a well-defined beam of high-frequency radio waves from an internal antenna. Some of this emitted energy reflects back to the receiving antenna. Signal processing electronics in the sensor determine the distance from the sensor to the object based on the time delay of the return signal. The sensor can be configured (via DIP switches) to sense objects up to a specific distance, ignoring objects beyond this distance (also called background suppression).

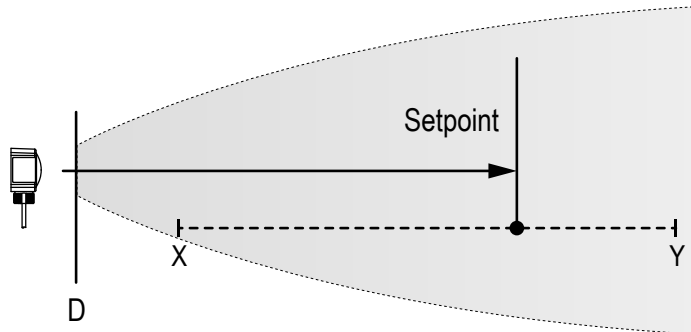

Figure 1. R-GAGE Setpoint

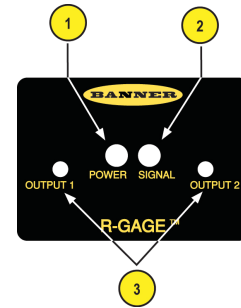

Figure 2. R-Gage Features

1. Power LED: Green (power ON)
2. Signal Strength LED: Red (flashes in proportion to the signal strength)
3. Output LEDs: Yellow (output energized); Red (configuration)

Access the DIP switches behind the threaded cap on the sensor back (not shown)

R-GAGE setpoint distances, minimum and maximum (sensor will detect objects up to setpoint and ignore objects beyond the setpoint)

		EU, KR Models	TW, US Models
X	Minimum setpoint distance	2 m (6.6 ft)	3.5 m (11.5 ft)
Y	Maximum setpoint distance	24 m (78.7 ft)	24 m (78.7 ft)
D	Dead Zone ³		

Sensor Configuration

The sensing zone distance, sensitivity, and output configuration can be selected via the DIP switches on the back of the sensor. Use the included spanner to open the screw-off cover on the back of the sensor and access the DIP switches.



Important: Tighten the DIP switch cover a full quarter turn after contact to maintain the watertight seal.

DIP Switch Functions

Switch	Function
1, 2, 3	Sensing distance (detects objects from sensor face to this point)
4, 5	Sensitivity (higher sensitivity sees weaker objects and has a larger beam pattern)
6	Normally open/normally closed output functionality
7, 8	Response Speed

DIP switch 1 is on the left and DIP switch 8 is on the right.

Distance Settings

* Default settings

³ Typical dead zone: 0.4 m (1.3 ft) for moving and 1.0 m (3.3 ft) for stationary targets, but varies with target reflectivity

Switch 1	Switch 2	Switch 3	Distance	
			EU, KR Models	TW, US Models
0	0	0	2 m (6.6 ft)	3.5 m (11.5 ft)
0	0	1	3 m (9.8 ft)	4 m (13.1 ft)
0	1	0	4 m (13.1 ft)	5 m (16.4 ft)
0	1	1	6 m (19.7 ft)	6 m (19.7 ft)
1*	0*	0*	8 m (26.2 ft)	8 m (26.2 ft)
1	0	1	12 m (39.4 ft)	12 m (39.4 ft)
1	1	0	16 m (52.5 ft)	16 m (52.5 ft)
1	1	1	24 m (78.7 ft)	24 m (78.7 ft)



Note: Highest sensitivity is achieved only if sensing distance is 8 m (26.2 ft) or less.



Note: Near-field sensitivity boost is enabled when set to 4 m (13.1 ft) or less.

Sensitivity Selection

Switch 4	Switch 5	Sensitivity
0*	0*	4 (Highest)
0	1	3 (High)
1	0	2 (Medium)
1	1	1 (Low)

* Default settings



Note: Use the sensitivity selection to ignore unwanted weak reflections within the field of view, and not to narrow the beam width. Narrow-beam R-GAGE sensor models are available.

Output Configuration

* Default settings

Switch 6	NO/NC
0*	NO
1	NC

Response Speed

Switch 7	Switch 8	On Total (ms)	Off Total (ms)	Total (ms)
0	0	30	70	100
0*	1*	50	300	350
1	0	30	1000	1030
1	1	120	6000	6120

* Default settings

Specifications

Range

The sensor is able to detect a proper object (see Detectable Objects) from 1 to 24 m (3.3 to 78.7 ft), depending on target

Detectable Objects

Objects containing metal, water, or similar high-dielectric materials

Operating Principle

Frequency modulated continuous-wave (FMCW) radar

Operating Frequency

US, TW Models: 24.075–24.175 GHz, ISM Band
EU, KR, SG Models: 24.050-24.250 GHz, ISM Band

Maximum Output Power

ERP: 3.3 mW, 5 dBm
EIRP: 100 mW, 20 dBm

Supply Voltage

12 to 30 V dc, less than 100 mA, exclusive of load
For KR models: 12 to 24 V dc, less than 100 mA exclusive of load

Supply Protection Circuitry

Protected against reverse polarity and transient overvoltages

Delay at Power-up

Less than 2 seconds

Output Configuration

Bipolar NPN/PNP output, 150mA; DIP switch 6 selects N.O. (default) or N.C. operation

Output Protection

Protected against short circuit conditions

Response Time

DIP switches 7 & 8 select ON/OFF response time

**Complies with
IMDA Standards
N1455-15**

Indicators

Power LED: Green (power ON)
Signal Strength LED: Red, flashes in proportion to signal strength. Steady on at 4x excess gain. Only indicates signal amplitude, not target distance.
Output LEDs: Yellow (output energized) / Red (configuration)
See [Figure 2](#) on page 2

Adjustments

DIP-switch-configurable sensing distance, sensitivity, response time, and output configuration

Construction

Housing: ABS/polycarbonate
Lightpipes: Acrylic
Access Cap: Polyester

Operating Temperature

–40 °C to +65 °C (–40 °F to +149 °F)

Environmental Rating

IEC IP67

Connections

Integral 5-wire 2 m (6.5 ft) cable or M12 Euro-style QD fitting. QD models require a mating cordset

Certifications



ETSI/EN 300 440
FCC part 15
RSS-210
ANATEL Category II
CMIIT Category G
ARIB STD T-73
KC mark - MSIP/RRA
NCC
IDA Singapore
for others, contact Banner Engineering
Country of Origin: USA

FCC ID: UE3QT50RUS—This device complies with Part 15 of the FCC Rules. Operation is subject to the following two conditions: (1) this device may not cause harmful interference, and (2) this device must accept any interference received, including interference that may cause undesired operation.

IC: 7044A-QT50RCA—This device complies with Industry Canada license-exempt RSS standard(s). Operation is subject to the following two conditions: (1) this device may not cause interference, and (2) this device must accept any interference, including interference that may cause undesired operation of the device.

Cet appareil est conforme aux CNR exempts de licence d'Industrie Canada. Son fonctionnement est soumis aux deux conditions suivantes: (1) Ce dispositif ne peut causer des interférences; et (2) Ce dispositif doit accepter toute interférence, y compris les interférences qui peuvent entraîner un mauvais fonctionnement de l'appareil.



Este equipamento opera em caráter secundário, isto é, não tem direito à proteção contra interferência prejudicial, mesmo de estações do mesmo tipo e não pode causar interferência a sistemas operando em caráter primário.

SRD24-IO3B24100.2TR0.1 South Korea Class A Certification

A ()

(A)

,가

Beam Pattern

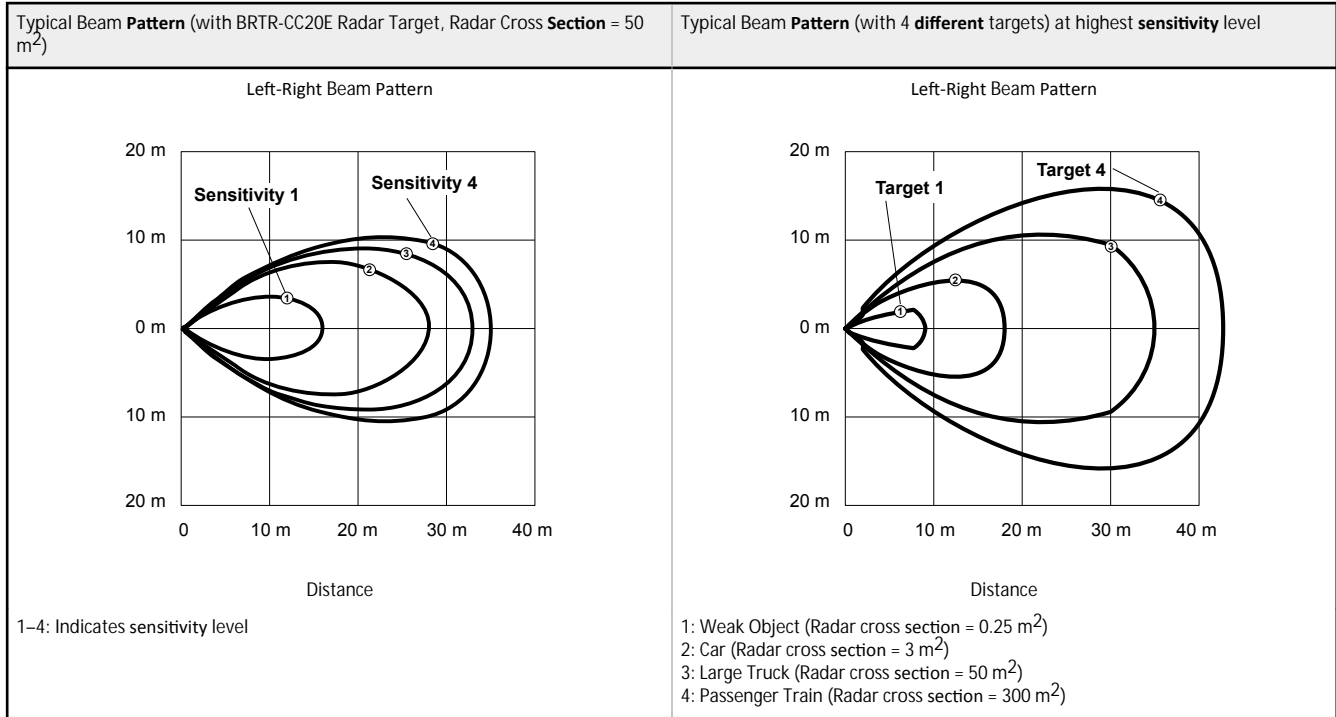

Note: The effective beam pattern depends on the sensitivity level and target properties.

Dimensions

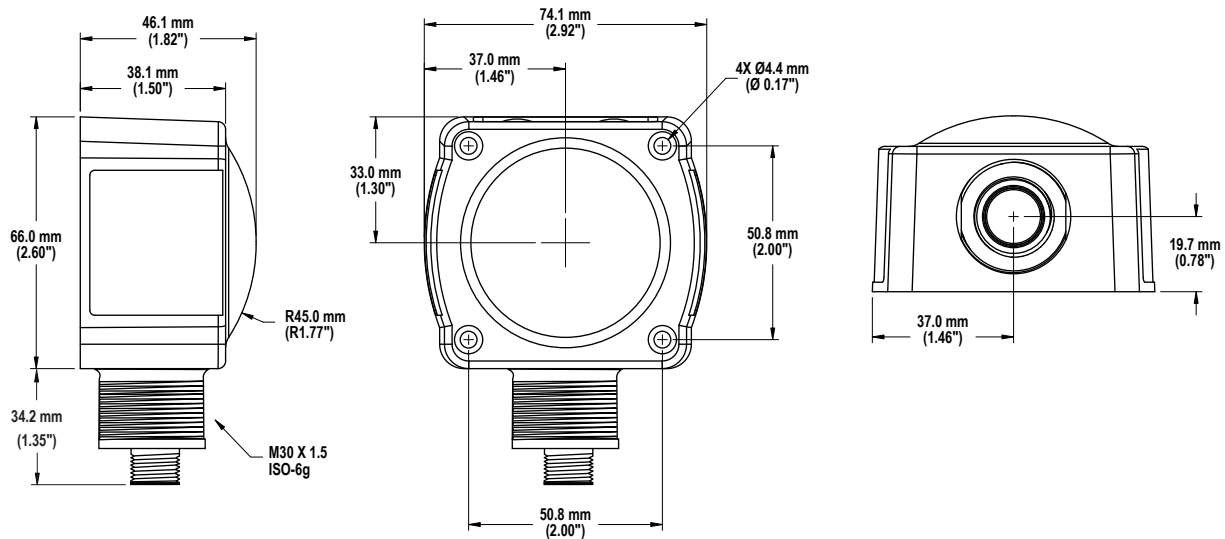

Windows

The R-GAGE sensor can be placed behind a glass or a plastic window, but the configuration must be tested and the distance from the sensor to the window must be determined and controlled prior to installation. There is typically a 20% signal reduction when the sensor is placed behind a window.

Polycarbonate at 4 mm thickness performs well in most situations, but the performance depends on filler materials. Thinner (1 to 3 mm) windows have high reflection. The amount of reflection depends on the material, thickness, and distance from the sensor to the window.

Locate the sensor in a position of minimum reflection from the window, which will repeat every 6.1 mm of distance between the sensor and the window. The positions of maximum reflection from the window repeat between the minimums, and decrease in effect until the window is approximately 150 mm (5.9 in) away. Consult the factory for pre-tested window materials which can be used at any distance without issue.

Additionally, the face of the window should be protected from flowing water and ice by use of a flow diverter or hood directly above the window. Falling rain or snow in the air in front of the window, light water mist, or small beads on the face of the window are typically not an issue. However, a thick, continuous surface of water or ice directly on the face of the window can be detected as a dielectric boundary.

Wiring

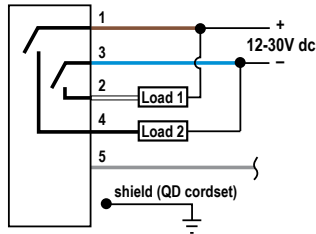

Wiring Key:

- 1 = Brown
- 2 = White
- 3 = Blue
- 4 = Black
- 5 = Gray (Do not connect)



Note: Banner recommends that the shield wire (QD cordsets only) be connected to earth ground or dc common. Shielded cordsets are recommended for all QD models.

Accessories

Quick Disconnect (QD) Cordsets

5-Pin Threaded M12/Euro-Style Cordsets—with Shield				
Model	Length	Style	Dimensions	Pinout (Female)
MQDEC2-506	1.83 m (6 ft)	Straight		<p>1 = Brown 2 = White 3 = Blue 4 = Black 5 = Gray</p>
MQDEC2-515	4.57 m (15 ft)			
MQDEC2-530	9.14 m (30 ft)			
MQDEC2-550	15.2 m (50 ft)			
MQDEC2-506RA	1.83 m (6 ft)	Right-Angle		
MQDEC2-515RA	4.57 m (15 ft)			
MQDEC2-530RA	9.14 m (30 ft)			
MQDEC2-550RA	15.2 m (50 ft)			



Note: Pin 5 is not used.

Mounting Brackets

All measurements are in mm

SMB30SC

- Swivel bracket with 30 mm mounting hole for sensor
- Black reinforced thermoplastic polyester
- Stainless steel mounting and swivel locking hardware included

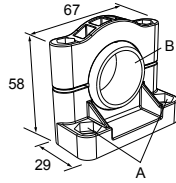

Hole center spacing: A=ø 50.8
Hole size: A=ø 7.0, B=ø 30.0

SMB30MM

- 12-ga. stainless steel bracket with curved mounting slots for versatile orientation
- Clearance for M6 (¼ in) hardware
- Mounting hole for 30 mm sensor

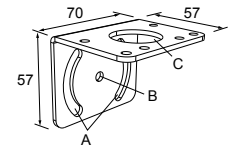

Hole center spacing: A = 51, A to B = 25.4
Hole size: A = 42.6 x 7, B = ø 6.4, C = ø 30.1

Weather Deflector

QT50RCK

- Required if the R-GAGE is exposed to rain or snow
- Prevents buildup of water or ice from interfering with sensor performance



Banner Engineering Corp. Limited Warranty

Banner Engineering Corp. warrants its products to be free from defects in material and workmanship for one year following the date of shipment. Banner Engineering Corp. will repair or replace, free of charge, any product of its manufacture which, at the time it is returned to the factory, is found to have been defective during the warranty period. This warranty does not cover damage or liability for misuse, abuse, or the improper application or installation of the Banner product.

THIS LIMITED WARRANTY IS EXCLUSIVE AND IN LIEU OF ALL OTHER WARRANTIES WHETHER EXPRESS OR IMPLIED (INCLUDING, WITHOUT LIMITATION, ANY WARRANTY OF MERCHANTABILITY OR FITNESS FOR A PARTICULAR PURPOSE), AND WHETHER ARISING UNDER COURSE OF PERFORMANCE, COURSE OF DEALING OR TRADE USAGE.

This Warranty is exclusive and limited to repair or, at the discretion of Banner Engineering Corp., replacement. IN NO EVENT SHALL BANNER ENGINEERING CORP. BE LIABLE TO BUYER OR ANY OTHER PERSON OR ENTITY FOR ANY EXTRA COSTS, EXPENSES, LOSSES, LOSS OF PROFITS, OR ANY INCIDENTAL, CONSEQUENTIAL OR SPECIAL DAMAGES RESULTING FROM ANY PRODUCT DEFECT OR FROM THE USE OR INABILITY TO USE THE PRODUCT, WHETHER ARISING IN CONTRACT OR WARRANTY, STATUTE, TORT, STRICT LIABILITY, NEGLIGENCE, OR OTHERWISE.

Banner Engineering Corp. reserves the right to change, modify or improve the design of the product without assuming any obligations or liabilities relating to any product previously manufactured by Banner Engineering Corp. Any misuse, abuse, or improper application or installation of this product or use of the product for personal protection applications when the product is identified as not intended for such purposes will void the product warranty. Any modifications to this product without prior express approval by Banner Engineering Corp will void the product warranties. All specifications published in this document are subject to change; Banner reserves the right to modify product specifications or update documentation at any time. Specifications and product information in English supersede that which is provided in any other language. For the most recent version of any documentation, refer to:

www.bannerengineering.com.