

WLB92



Industrial LED Light Bar

The WLB92: Rugged durability for the factory—Design aesthetics for an office.

- Increase worker productivity and ergonomics with bright, high-quality, uniform light
- Durable light stands up in your environment with a rugged metal housing and shatterproof light cover
- No maintenance time or cost with long-life, energy-efficient LEDs and driver circuitry
- Flexibility to place light where needed with ac and dc models
- Easy installation with variety of mounting options: surface, swivel, snap and hanging brackets
- AC models are DLC certified, have a five year warranty and are rebate eligible

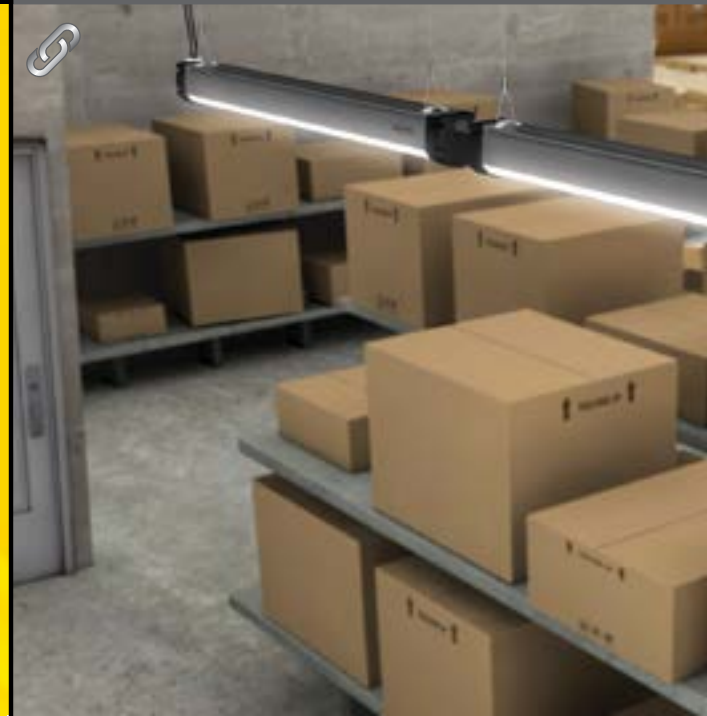

WLB92
Industrial LED Light Bar

Advanced LED lighting for your factory, flexibility for you.

With the WLB92, there are a variety of mounting options, ac and dc models and a dimming function available to suit your lighting needs.

AC or DC models available with a variety of connection options

Models available with industry-standard conduit knockouts for continuous run and permanent installations

Dimming knob (optional) allows you to customize light levels

ON/OFF switch

Rugged, anodized aluminum housing

Choose from two lengths: 550 or 1100 mm



Available in 6 colors

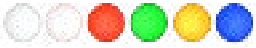

Impact-resistant, light-diffusing polycarbonate window for even light output

Quick-disconnect for cabinet, bench and portable applications.



LMBWLB92HK5

Hanging bracket kit allows for suspended installation.

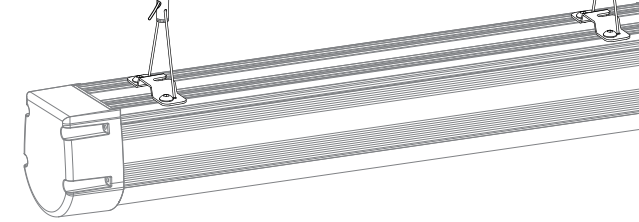

LMBWLB92RAS

Swivel brackets allow for 180° of movement in seven fixed positions.

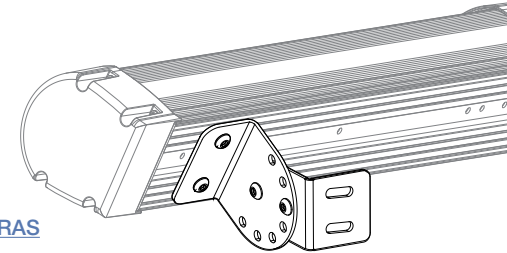

Simple Installation with a Variety of Mounting Options

Choose from surface, swivel, snap and hanging brackets.

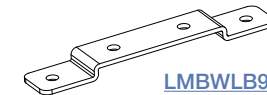

LMBWLB92

Surface mount brackets allow for mounting at the end of the light.

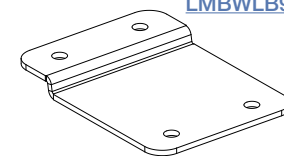

LMBWLB92S

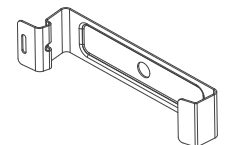

LMBWLB92CLIP

Snap clips allow for a tool-less installation.



WLB92
Industrial LED Light Bar

AC Conduit Models example: WLB92ZC550ACT

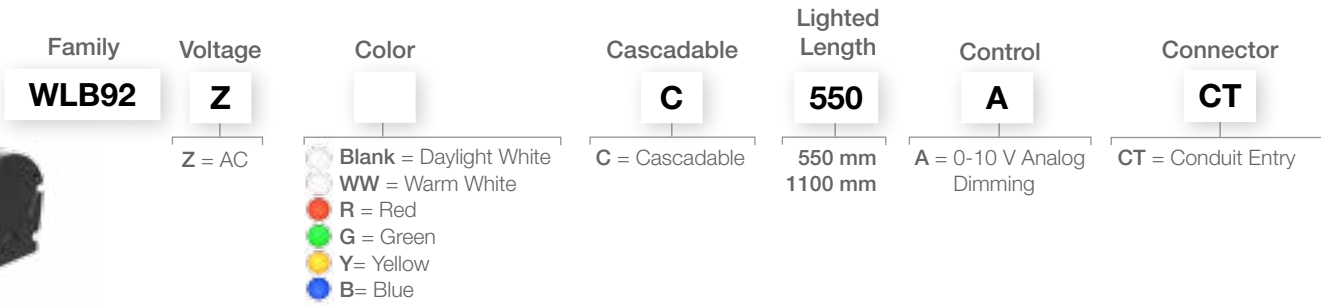

AC Quick-Disconnect Models example: WLB92ZC550PBQMB



DC Models example: WLB92X550PBQ

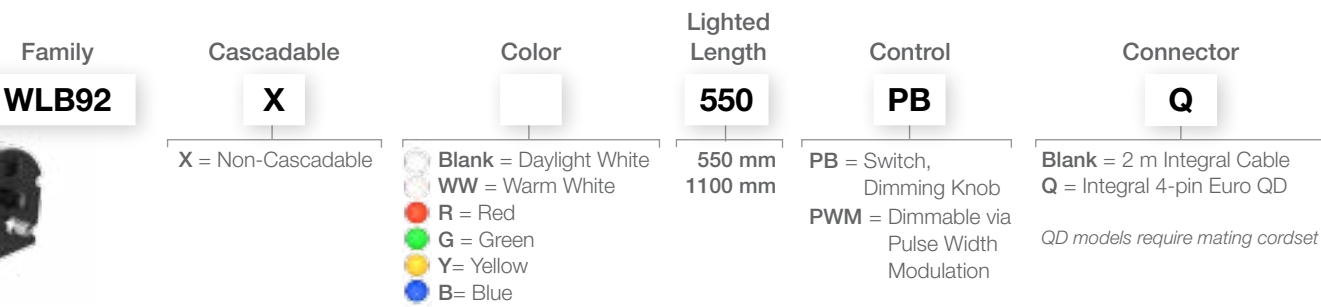

Accessories

AC Power Cordset 1.8 m (6') for use with models using QM connector



- [LQMAC-306](#) Flying Leads
- [LQMAC-306B](#) North & Central America, Japan, Taiwan
- [LQMAC-306D](#) India, Sri Lanka, Nepal, Namibia
- [LQMAC-306EF](#) France, Belgium, Slovakia, Tunisia, Germany, Austria, Netherlands, Spain, S. Korea
- [LQMAC-306G](#) UK, Ireland, Cyprus, Malta, Malaysia, Singapore, Hong Kong, Vietnam
- [LQMAC-306I](#) Australia, New Zealand, Papua New Guinea, Argentina, China
- [LQMAC-306N](#) Brazil, South Africa



For use with DC models
4-Pin M12/ Euro-Style Cordsets
Straight connector models listed; for right-angle, add RA to the end of the model number (example, MQDC-406RA)

- [MQDC-406](#) 2 m (6.5')
- [MQDC-415](#) 5 m (15')
- [MQDC-430](#) 9 m (30')



WLB92
Industrial LED Light Bar

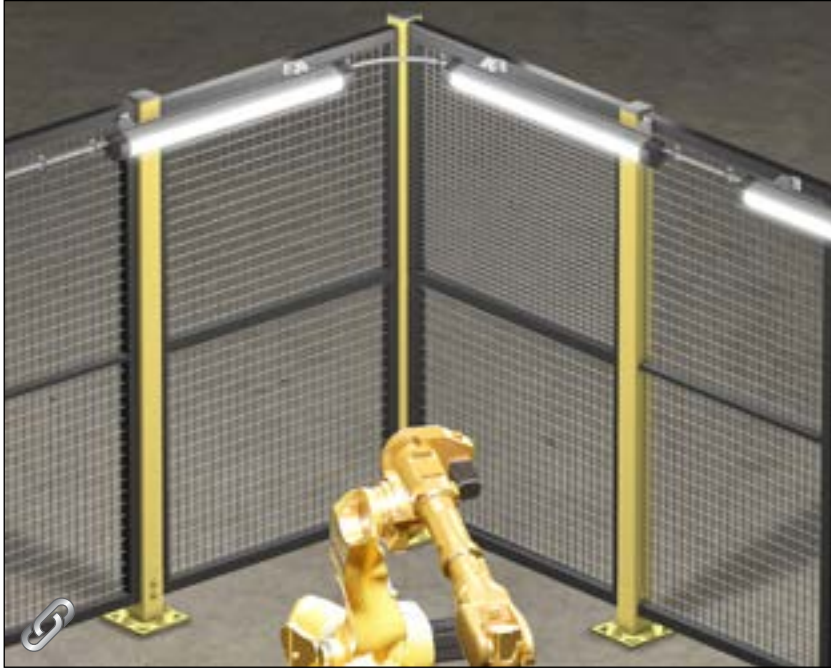

Robotic Work Cell Lighting



High-Quality LED Lights Improve Quality Inspection



WLB92
Industrial LED Light Bar

Link to
data sheets

WLC90 Heavy Duty LED Light

Banner's WLC90 Heavy Duty LED Light is designed to operate in harsh environments. It features a rugged, die-cast aluminum housing with a built-in mounting bracket for easy installation. The light is available in three different beam angles, making it an excellent choice for machine guarding and food processing applications.

- Rugged, die-cast aluminum housing with IP67 rating and shock/vibration resistance
- Wide operating temperature range with an optional mounting bracket that fits the LED in a safe level of exposure temperature
- Three beam choices to suit your application needs
- Six and six brackets for versatile mounting to direct the light in any direction
- Models have three discrete intensity level settings

Model	Beam Angle	Connection	Window
WLC90W150	15° Beam	Integral 4-Pin Euro QD Side Exit	None
WLC90W30	30° Beam	Integral 4-Pin Euro QD Side Exit	None
WLC90W60	60° Beam	Integral 4-Pin Euro QD Side Exit	None
WLC90W150	15° Beam	Integral 4-Pin Euro QD Rear Exit	None
WLC90W30	30° Beam	Integral 4-Pin Euro QD Rear Exit	None
WLC90W60	60° Beam	Integral 4-Pin Euro QD Rear Exit	None



Link to
catalog

Link to the
Banner website

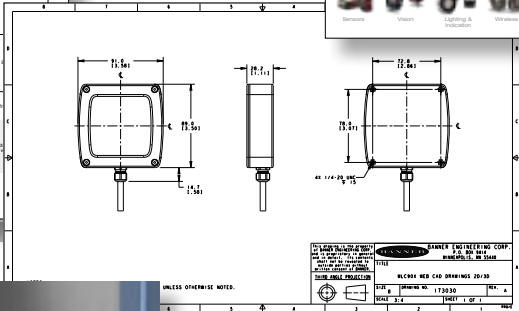

Link to
CAD files



Link to videos



Talk with an app engineer. Get product specs. Order now.
1-888-373-6767 • bannerengineering.com
Minneapolis, MN

