

QS30ELVC Series Clear Object Retroreflective Sensor



Datasheet



- Reliable detection of clear, translucent, or opaque targets — including mirror-like surfaces
- Automatic compensation algorithm compensates for dust or contamination on the sensor or reflector and for ambient temperature changes
- Three selectable thresholds based on type of target being detected
- Easy configuration via push buttons or remote wire
- Easy-to-read operating status indicators
- Rugged housing for harsh environments; rated IP67 (NEMA 6), 1200 psi washdown per NEMA PW12
- Compact housing, mounting versatility — 30 mm threaded barrel or side-mount



WARNING:

- **Do not use this device for personnel protection**
- Using this device for personnel protection could result in serious injury or death.
- This device does not include the self-checking redundant circuitry necessary to allow its use in personnel safety applications. A device failure or malfunction can cause either an energized (on) or de-energized (off) output condition.

Models

Model	Sensing Range and Use ¹	Cable	Supply Voltage	Output
QS30ELVC	100 mm to 2 m (3.9 in to 78 in); Light SET for clear object detection	2 m (6.5 ft) unterminated 5-wire PVC-jacketed cable	10 V DC to 30 V DC	Bipolar (NPN and PNP)
QS30ELVCQ		Integral 5-pin M12 male quick-disconnect connector		

To order a model with a 9 m (30 ft) cable, add the suffix **W/30** to the model number (for example, **QS30ELVC W/30**).

To order a model with a 150 mm (6 in) cable with a 5-pin M12 connector, add the suffix **Q5** to the model number (for example, **QS30ELVCQ5**).

To order a model with a 150 mm (6 in) PUR cable with a 5-pin M12 connector, add the suffix **QPMA** to the model number (for example, **QS30ELVCQPMA**).

Models with an M12 connector require a mating cordset (see [Accessories](#) on page 8).

Overview

The QS30ELVC is an easy-to-use, high-performance retroreflective sensor optimized for detection of clear, translucent, or opaque objects. The optical design of the sensor ensures reliable detection of PET bottles, glass containers, and optically engineered surfaces such as mirrors, LCD glass with polarizing films, or semi-conductor wafers. The sensor will not be tricked by specular reflections from the object under normal operating conditions.

The compact housing has a large, easy-to-see bargraph display for easy configuration and status monitoring during operation. The sensor housing can be side-mounted, using integral mounting holes, or front-mounted, via the 30 mm threaded barrel. A wide assortment of mounting brackets are also available for applications requiring adjustability or robust mechanical protection.

The QS30ELVC is configured for operation using the Light SET procedure. The sensor is simply aligned to the included retroreflective target and the Light SET is initiated either via the push button or the remote wire input. A reliable detection is assured when the appropriate threshold for clear, translucent or dark object is selected.

Continued reliable operation is maintained as the thresholds adapt to changing signal levels over time using Banner Engineering's auto compensation tracking algorithm. The sensor tracks the amount of light returned at every opportunity and makes fine adjustments to the switching threshold as required due to dust or contamination in the environment building up on the lens window or reflector. If the retroreflector is cleaned, returning the light to its original level, the sensor quickly adapts and continues operating with no need to perform another Light SET procedure.

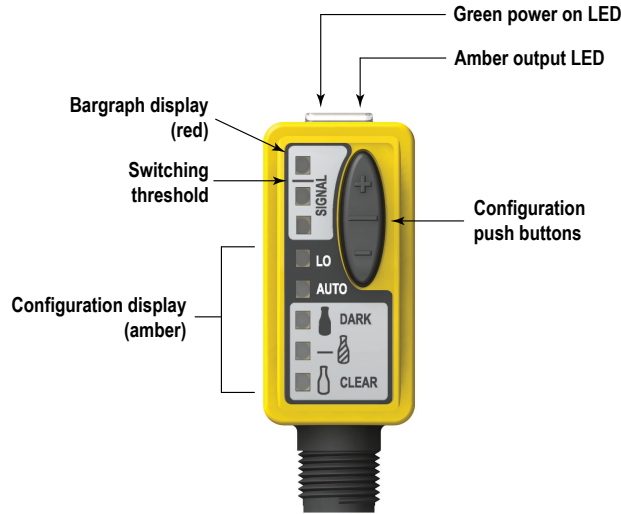
The sensor can recover from a cold power-up by re-using the stored threshold values from the last Light SET procedure. You only need to perform the Light SET procedure if the sensor is moved or the sensor to reflector separation distance is changed.

The sensor ships from the factory as a DARK OPERATE (DO), non-polarized retroreflective sensor with auto compensation enabled for easy set-up and reliable operation. The automatic compensation tracking algorithm can be disabled if required through the user SETUP buttons or the remote teach wire.

¹ Operation at shorter and longer distances possible. Contact factory for applications assistance.

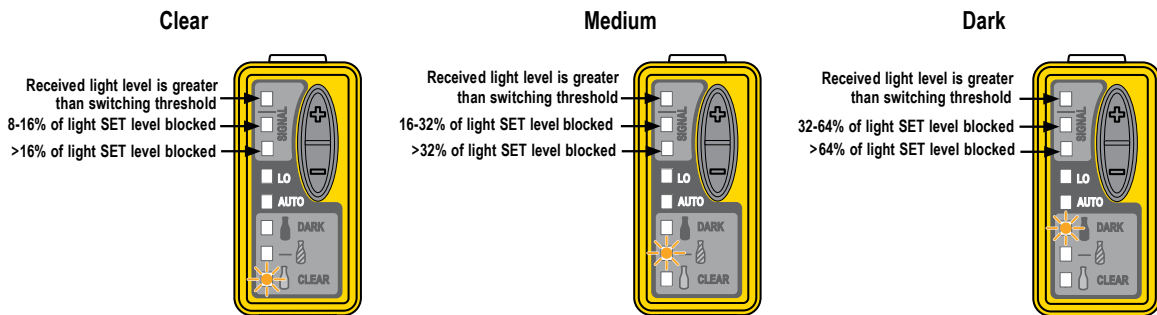


Figure 1. QS30ELVC features



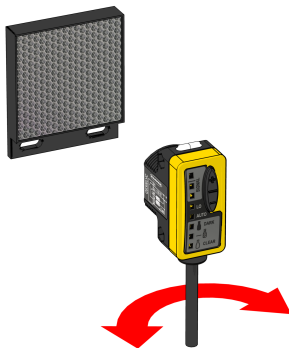
The sensor's compact housing has a large, easy-to-see bargraph display plus bright LEDs for easy configuration and status monitoring during operation. Sensor power and output state are indicated by the green and amber LEDs located at the top of the sensor. Sensor configuration is indicated by the 5-segment amber display. Signal strength relative to the switchpoint is indicated by the 3-segment red Signal bargraph.

Figure 2. Indicators



Applications

Figure 3. Clear bottle or object detection



Clear Bottle or Object Detection

1. Mount the retroreflector.
2. Align the sensor to the retroreflector.
3. Perform Light SET with no object present (see [Perform a Single-Point Light Set](#) on page 3).
4. Using Switchpoint Adjustment ([Selecting the Switchpoint](#) on page 4), select the darkest switchpoint which reliably detects the object. Medium level (16% below the signal from the retroreflector) will work for most applications. Dark level will provide more robust detection under difficult environmental conditions (e.g. dust, vibration, etc).

Figure 4. Clear bottle or object counting

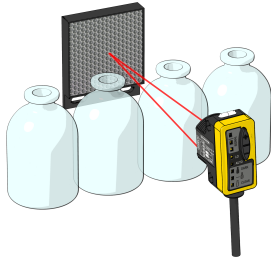
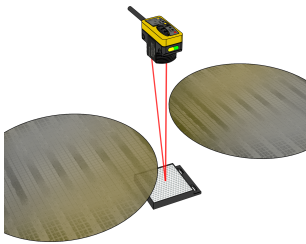


Figure 5. Reflective object detection



Clear Bottle or Object Counting

1. Mount the retroreflector.
2. Align the sensor to the retroreflector.
3. Disable the auto compensation function. Allow for 10 minute sensor warm-up period.
4. Position the bottles or objects so the beam is passing through the gap between the bottles.
5. Perform Light SET on the gap condition (see [Perform a Single-Point Light Set](#) on page 3).
6. Using Switchpoint Adjustment ([Selecting the Switchpoint](#) on page 4), select the darkest switchpoint which reliably detects the object. Medium level (16% below the signal from the retroreflector) will work for most applications. Dark level may provide more robust detection under difficult environmental conditions (e.g. dust, vibration, etc).

Reflective Object Detection

1. Mount the retroreflector.
2. Align the sensor to the retroreflector.
3. Perform Light SET with no object present (see [Perform a Single-Point Light Set](#) on page 3).
4. Using Switchpoint Adjustment ([Selecting the Switchpoint](#) on page 4), select clear or medium switchpoint percentage (8% or 16% below the signal from the retroreflector). This will reduce the chance of specular reflection affecting the sensor.

Wiring Diagrams

Figure 6. Cabled models

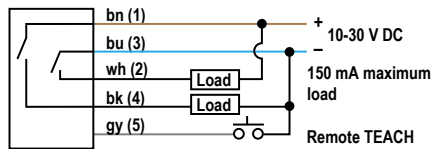


Figure 7. M12 models

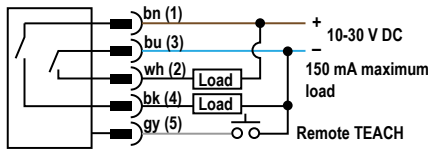
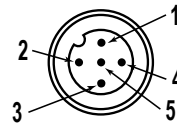


Figure 8. 5-pin M12 male pinout



Configuration Instructions

Perform a Single-Point Light Set

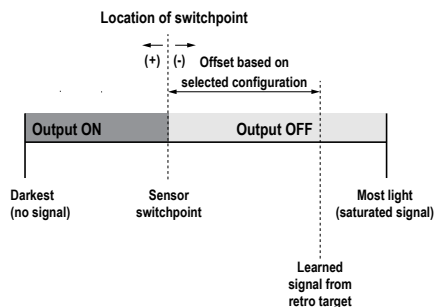
A single-point light set is useful for clear object detection and other applications with small variations in contrast. Use this procedure to set a switchpoint at 8 (clear), 16 (medium) or 32 (dark) percent below the signal from the retroreflector.

Select the switchpoint position using the + and - buttons. Select 8, 16, or 32 percent (Switchpoint Selection).

The sensor must be aimed at the reflector during the Set process. All conditions darker than the switchpoint condition result in an ON output (Dark Operate). Output ON and OFF conditions can be reversed by changing Light/Dark Operate in Setup mode. The factory default setting is Dark Operate.

The duration of each button click or remote input pulse is defined as T, where T is: 0.04 s < T < 0.8 s.

Figure 9. Low-contrast Set (Dark Operate) shown.



1. Align the sensor to the reflector.
2. Set the switchpoint.
 - Push buttons: Press and hold + for more than 2 seconds.
 - Remote: Single-pulse the remote line.

The green power LED is off, the amber output LED is on, and the bargraph's two top signal LEDs flash alternately.

If the switchpoint was accepted: the green power LED is on, the amber output LED is on for light operate or off for dark operate, and the bargraph's appropriate LEDs are ON. The sensor returns to RUN mode with new settings.

If the switchpoint was not accepted: the green power LED is on, the amber output LED is flashing (alarm state), and the bargraph is off.

Configure the Sensor Using Setup Mode

Use Setup Mode to change sensor configuration:

- Light or Dark operate
- Enable or disable automatic compensation algorithm

If Setup Mode programming is interrupted and remains inactive for 60 seconds, the sensor returns to Run mode with the most recent settings (for example, exits and saves the current selection). Setup Mode operates in the background while the outputs are active; changes are updated instantly.

The sensor can be configured using the remote line (see [Remote Line TEACH](#) on page 5).

The duration of each button click or remote input pulse is defined as T, where T is: $0.04\text{ s} < T < 0.8\text{ s}$.

1. To access Setup Mode, press and hold both push buttons > 2 seconds.
The green Power LED is off, the amber Output LED remains active, and the bargraph status indicators (LO and AUTO) flashes the current configuration.
2. To select the setting combination, click either push button until the LEDs show the desired settings.

The sensor rotates through four setting combinations, in the following order:

Setting Combination	AUTO LED	LO LED
Auto Compensation ON/DO (factory default)	On	Off
Auto Compensation ON/LO	On	On
Auto Compensation OFF/LO	Off	On
Auto Compensation OFF/DO	Off	Off

3. Press and hold both push buttons > 2 seconds to return to Run Mode with your new settings.
The green Power LED is on, the amber Output LED remains active, and the bargraph indicates the current configuration. The sensor returns to Run Mode with the new settings.

Selecting the Switchpoint

The switchpoint can be selected during Run Mode using either the push buttons or the remote wire.

To select the switchpoint selection using the push buttons, press the + and - buttons. There are three possible choices: 8, 16, or 32 percent below the signal from the retroreflector. The selection does not wrap around, so use both the + and - buttons to select your value.

The sensor continues operating normally with the newly selected threshold value. It is not necessary to repeat the light set procedure.

Push Button Disable

In addition to its configuration function, the remote wire may be used to disable the push buttons for security. Disabling the push buttons prevents accidental or unauthorized adjustment of the sensor settings. Connect the gray wire of the sensor as described in [Remote Line TEACH](#) on page 5, and four-pulse to either enable or disable the push buttons:



Alarm State

The QS30ELVC Alarm State indicates that the sensor requires attention. In all situations, clear the alarm by realigning the sensor to the retroreflector, cleaning the sensor or retroreflector of contamination, and performing a Light SET to establish a valid light signal.

Alarm State is indicated by:

- Amber Output LED is flashing
- All three red Signal LEDs are off
- Output forced to blocked state (for example, if the sensor is in dark operate (DO), the output is conducting)

The sensor may enter Alarm State for three reasons:

1. The sensor may be in Alarm State when first powered up. This is normal operation and does not indicate a problem with the sensor. The Alarm State will be cleared when a valid Light SET is performed.

2. The sensor enters Alarm State if the Light SET procedure fails. This indicates the sensor did not receive enough light from the retroreflector for reliable detection. Realign the sensor to the retroreflector, making sure all optical surfaces are free of contamination. If the automatic compensation algorithm is enabled, the sensor may recover at this point and begin operating normally. It is not necessary to repeat the Light SET procedure. If automatic compensation has been disabled, the sensor remains in the Alarm State until the alignment has been corrected and a Light SET is successfully completed.
3. The sensor can enter Alarm State if the auto compensation algorithm is enabled and the sensor has automatically adjusted the threshold as much as possible. The sensor and retroreflector should be cleaned or the sensor should be realigned to the retroreflector. The sensor will automatically adapt to the new light level, or a Light SET can be performed to reestablish the light level.

In any case, the sensor can be returned to normal operation by ensuring a clean optical path, aligning the sensor to the retroreflector, and performing a Light SET procedure on the sensor.

Remote Line TEACH

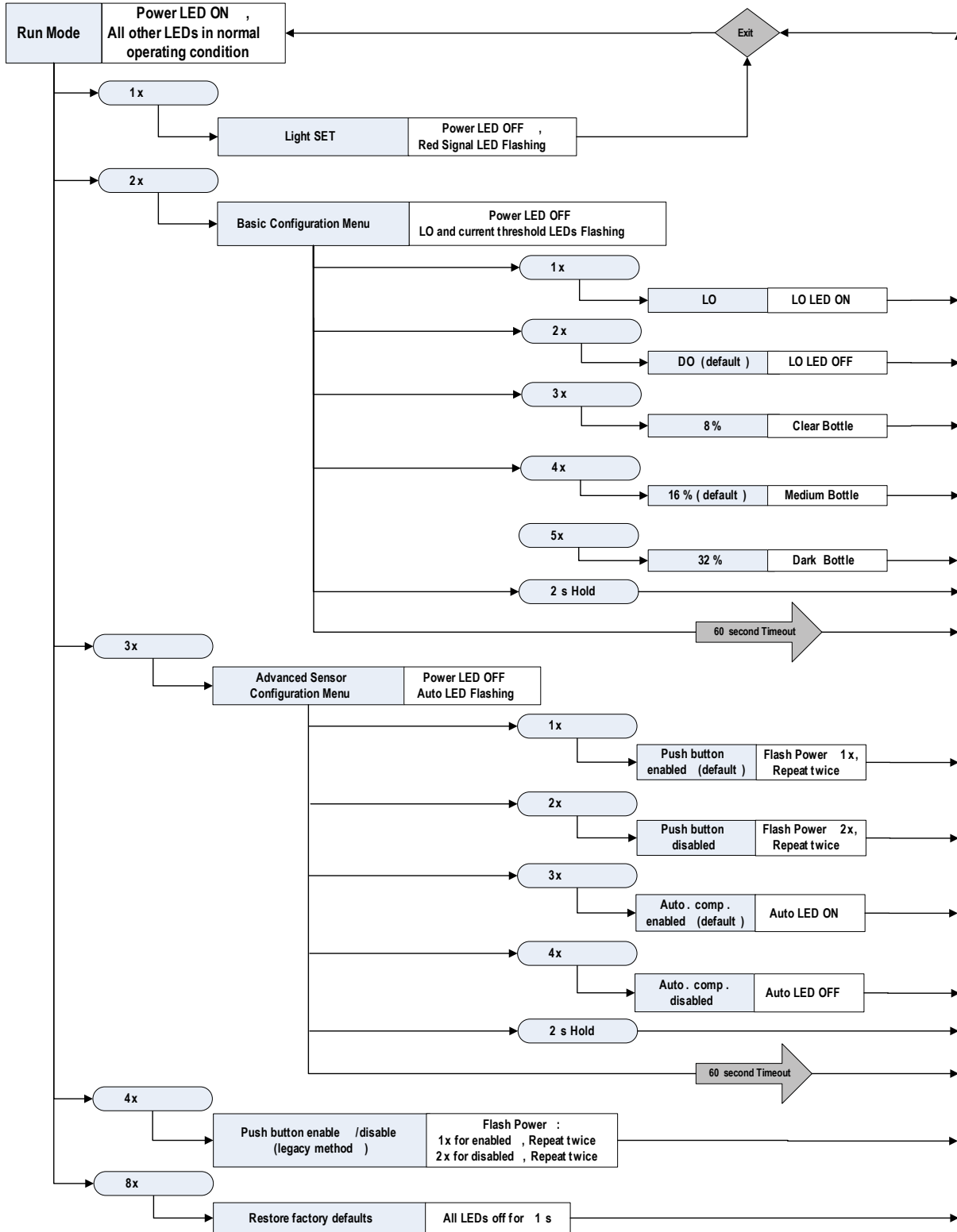
Connect the gray wire of the sensor to ground (0 V DC), with a remote programming switch connected between them.

Run Mode is the sensor's normal operating condition.

The duration of each button click or remote input pulse is defined as T, where T is: $0.04 \text{ s} < T < 0.8 \text{ s}$.

A Hold will exit TEACH Mode and return to Run Mode with the previously saved changes. The duration of a Hold is: $T > 2 \text{ s}$. A Timeout will occur if a condition is not registered within 60 seconds, causing the sensor to return to Run Mode (during sensor configuration only). Sensor configuration user feedback is shown on the green LED. See flow chart below.

Figure 10. Remote line TEACH flowchart



Specifications

Supply Voltage

10 V DC to 30 V DC (10% maximum ripple) at 25 mA maximum current, exclusive of load

Supply Protection Circuitry

Protected against reverse polarity, overvoltage, and transient voltages

Output Protection

Protected against output short-circuit, continuous overload, transient overvoltages, and false pulse on power up

Delay at Power-Up

250 ms; outputs do not conduct during this time

Sensing Beam

660 nm visible red LED

Sensing Range and Use

100 mm to 2 m (3.9" to 78"); Light SET for clear object detection

Indicators

Green LED: Power ON and feedback on configuration and remote wire pulses

Amber LED: Output conducting or error condition (flashing)

Three-Segment Red Signal Bargraph: Signal strength (excess gain), relative to switchpoint

Five-Segment Amber Display: Sensor Configuration

Adjustments

Two push buttons and remote wire

Easy push-button configuration and deterministic remote wire configuration

Select from 3 standard thresholds based on object being detected

Light Operate/Dark Operate configuration options selectable via push buttons or remote wire

Push-button lockout (from remote wire only)

Construction

ABS plastic housing; acrylic lens cover

Output Configuration

Bipolar: 1 current sourcing (PNP) and 1 current sinking (NPN)

Output Ratings

150 mA maximum load; see Application Note 1

OFF-state leakage current: < 50 µA at 30 V DC

ON-state saturation voltage:

NPN: < 200 mV at 10 mA; < 1 V at 150 mA

PNP: < 1.25V at 10 mA; < 2 V at 150 mA

Output Response Time

500 microseconds

Repeatability

150 microseconds

Environmental Rating

Leakproof design rated IEC IP67 (NEMA 6); PW12 1200 PSI washdown

Connections

5-wire 2 m (6.5 ft) PVC cable, 5-wire 9 m (30 ft) PVC cable, 150 mm (6 in) cable with a 5-pin M12 quick disconnect connector, 150 mm (6 in) PUR cable with 5-pin M12 quick disconnect connector, or a 5-pin integral M12 quick-disconnect connector, depending on the model ordered

Operating Conditions

-10 °C to +55 °C (+14 °F to +131 °F)

95% at +50 °C maximum relative humidity (non-condensing)

Vibration and Mechanical Shock

All models meet MIL-STD-202F, Method 201A (Vibration: 10 Hz to 60 Hz maximum, 0.06 inch (1.52 mm) double amplitude, 10G maximum acceleration) requirements. Also meets IEC 60947-5-2 (Shock: 30G 11 ms duration, half sine wave) requirements.

Application Notes

If the supply voltage is > 24 V DC, derate maximum output current 1 mA/°C above 25 °C

Certifications



Banner Engineering
Europe Park Lane,
Culliganlaan 2F bus 3, 1831
Diegem, BELGIUM



Turck Banner LTD Blenheim
House, Blenheim Court,
Wickford, Essex SS11 8YT,
Great Britain



Required Overcurrent Protection



WARNING: Electrical connections must be made by qualified personnel in accordance with local and national electrical codes and regulations.

Overcurrent protection is required to be provided by end product application per the supplied table.

Overcurrent protection may be provided with external fusing or via Current Limiting, Class 2 Power Supply.

Supply wiring leads < 24 AWG shall not be spliced.

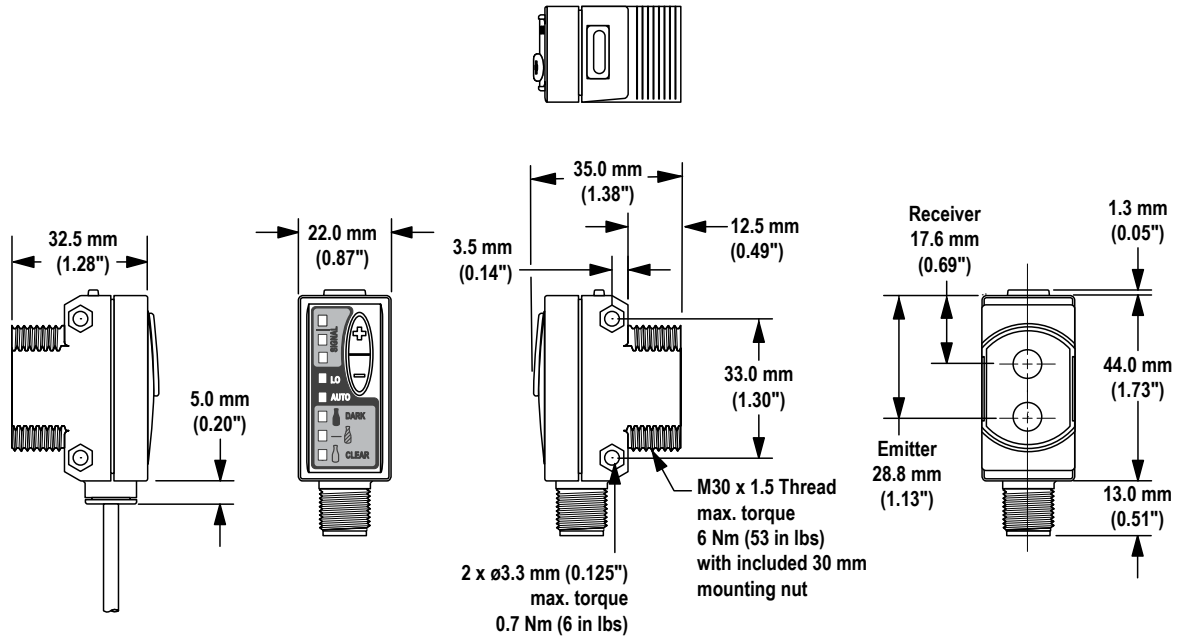
For additional product support, go to www.bannerengineering.com.

Supply Wiring (AWG)	Required Overcurrent Protection (Amps)
20	5.0
22	3.0
24	2.0
26	1.0
28	0.8
30	0.5

Dimensions

All measurements are listed in millimeters [inches], unless noted otherwise.

Figure 11. Dimensions for the cabled and QD models



Hardware Included: (10) M3 × 0.5 × 28 stainless steel machine screws, nuts, and washers

Accessories

5-Pin Threaded M12 Cordsets—Single Ended				
Model	Length	Style	Dimensions	Pinout (Female)
MQDC1-501.5	0.5 m (1.5 ft)	Straight		
MQDC1-503	0.9 m (2.9 ft)			
MQDC1-506	2 m (6.5 ft)			
MQDC1-515	5 m (16.4 ft)			
MQDC1-530	9 m (29.5 ft)			
MQDC1-560	18 m (59 ft)			
MQDC1-506RA	2 m (6.5 ft)	Right-Angle		<p>1 = Brown 2 = White 3 = Blue 4 = Black 5 = Gray</p>
MQDC1-515RA	5 m (16.4 ft)			
MQDC1-530RA	9 m (29.5 ft)			
MQDC1-560RA	19 m (62.3 ft)			

SMBQS30L

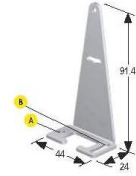
- Right-angle bracket for cable sensor models
- Clearance for M4 (#8) hardware
- ± 12° tilt adjustment
- 14-ga. stainless steel



Hole center spacing: A to B=35.0
Hole size: A=∅ 4.3, B=∅ 4.25x16.3

SMBQS30LT

- Tall right-angle bracket for QD models
- ± 8° tilt adjustment
- 14-ga. stainless steel



Hole center spacing: A to B=35.0
Hole size: A=∅ 4.3, B=∅ 4.25x16.3

SMBQS30Y

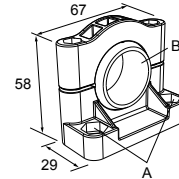
- Heavy-duty die-cast bracket
- M18 vertical mount option
- ± 8° tilt adjustment with cabled units
- Includes nuts and lock washer



Hole size: A=∅ 15.3

SMB30SC

- Swivel bracket with 30 mm mounting hole for sensor
- Black reinforced thermoplastic polyester
- Stainless steel mounting and swivel locking hardware included



Hole center spacing: A=∅ 50.8
Hole size: A=∅ 7.0, B=∅ 30.0

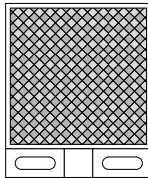
Other compatible mounting brackets include:

- SMB30MM
- SMB30A
- SMB30FA

Banner offers a wide selection of high-quality retroreflective targets. QS30ELVC sensors require corner cube type, large facet retroreflective targets only. Microprism and flexible tape reflectors are not recommended.

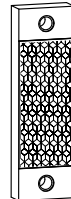
BRT-2X2LVC

- Square, acrylic target
- Reflectivity Factor: 1.0
- Temperature: -20 °C to +60 °C (-4 °F to +140 °F)
- Optional brackets are available
- Approximate size: 51 mm × 51 mm



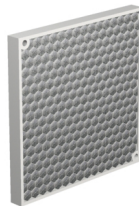
BRT-40X19A

- Rectangular, acrylic target
- Reflectivity Factor: 1.3
- Temperature: -20 °C to +60 °C (-4 °F to +140 °F)
- Approximate size: 19 mm × 60 mm overall; 19 mm × 40 mm reflector



BRT-92X92C

- Square, acrylic target
- Reflectivity Factor: 3.0
- Temperature: -20 °C to +60 °C (-4 °F to +140 °F)
- Optional brackets are available
- Approximate size: 92 mm × 92 mm



Reflectivity factors are when compared with the standard BRT-3 reflector.

Banner Engineering Corp Limited Warranty

Banner Engineering Corp. warrants its products to be free from defects in material and workmanship for one year following the date of shipment. Banner Engineering Corp. will repair or replace, free of charge, any product of its manufacture which, at the time it is returned to the factory, is found to have been defective during the warranty period. This warranty does not cover damage or liability for misuse, abuse, or the improper application or installation of the Banner product.

THIS LIMITED WARRANTY IS EXCLUSIVE AND IN LIEU OF ALL OTHER WARRANTIES WHETHER EXPRESS OR IMPLIED (INCLUDING, WITHOUT LIMITATION, ANY WARRANTY OF MERCHANTABILITY OR FITNESS FOR A PARTICULAR PURPOSE), AND WHETHER ARISING UNDER COURSE OF PERFORMANCE, COURSE OF DEALING OR TRADE USAGE.

This Warranty is exclusive and limited to repair or, at the discretion of Banner Engineering Corp., replacement. **IN NO EVENT SHALL BANNER ENGINEERING CORP. BE LIABLE TO BUYER OR ANY OTHER PERSON OR ENTITY FOR ANY EXTRA COSTS, EXPENSES, LOSSES, LOSS OF PROFITS, OR ANY INCIDENTAL, CONSEQUENTIAL OR SPECIAL DAMAGES RESULTING FROM ANY PRODUCT DEFECT OR FROM THE USE OR INABILITY TO USE THE PRODUCT, WHETHER ARISING IN CONTRACT OR WARRANTY, STATUTE, TORT, STRICT LIABILITY, NEGLIGENCE, OR OTHERWISE.**

Banner Engineering Corp. reserves the right to change, modify or improve the design of the product without assuming any obligations or liabilities relating to any product previously manufactured by Banner Engineering Corp. Any misuse, abuse, or improper application or installation of this product or use of the product for personal protection applications when the product is identified as not intended for such purposes will void the product warranty. Any modifications to this product without prior express approval by Banner Engineering Corp will void the product warranties. All specifications published in this document are subject to change; Banner reserves the right to modify product specifications or update documentation at any time. Specifications and product information in English supersede that which is provided in any other language. For the most recent version of any documentation, refer to: www.bannerengineering.com.

For patent information, see www.bannerengineering.com/patents.



more sensors, more solutions