

EZ-LIGHT® K70 Wireless Indicator Light

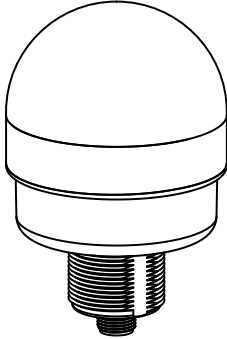

Datasheet

Sure Cross® K70 Wireless Indicator Lights combine the best of Banner's popular Indicator Light family with its reliable, field proven, Sure Cross wireless architecture.



- Available in 900 MHz and 2.4 GHz ISM Bands
- Up to five colors in one device
- Rugged, water-resistant IP65 housing with UV-stabilized material
- Bright, uniform indicator segments appear gray when off to eliminate false indication from ambient light
- Two-way communication - lights can be controlled with the input wires or the Gateway
- Input wires can be configured as auxiliary sourcing inputs from external devices or as a 20 Hz, 32-bit event counter

Models

900 MHz Models			
Model	No. of Colors	Colors	Connection
K70DXN9RQ	1	Red	Integral 5-pin M12/Euro-style male quick disconnect (QD)
K70DXN9GRQ	2	Green, Red	
K70DXN9GYRQ	3	Green, Yellow, Red	
K70DXN9BGYRQ	4	Blue, Green, Yellow, Red	Integral 8-pin M12/Euro-style male quick disconnect (QD)
K70DXN9WBGYRQ	5	White, Blue, Green, Yellow, Red	

2.4 GHz Models			
Model	No. of Colors	Colors	Connection
K70DXN2RQ	1	Red	Integral 5-pin M12/Euro-style male quick disconnect (QD)
K70DXN2GRQ	2	Green, Red	
K70DXN2GYRQ	3	Green, Yellow, Red	
K70DXN2BGYRQ	4	Blue, Green, Yellow, Red	Integral 8-pin M12/Euro-style male quick disconnect (QD)
K70DXN2WBGYRQ	5	White, Blue, Green, Yellow, Red	

Integral quick disconnect models are listed; a mating corset is required (see [Accessories](#) on page 8).

- To order the 150mm (5.9 in) PVC pigtail with quick disconnect model, replace the Q with QP in the model number, for example K70DXN9RQP.
- To order the 2 m (6.5 ft) cable models, omit the suffix Q in the model number, for example K70DXN9R.



Installation Instructions

Assembling the K70

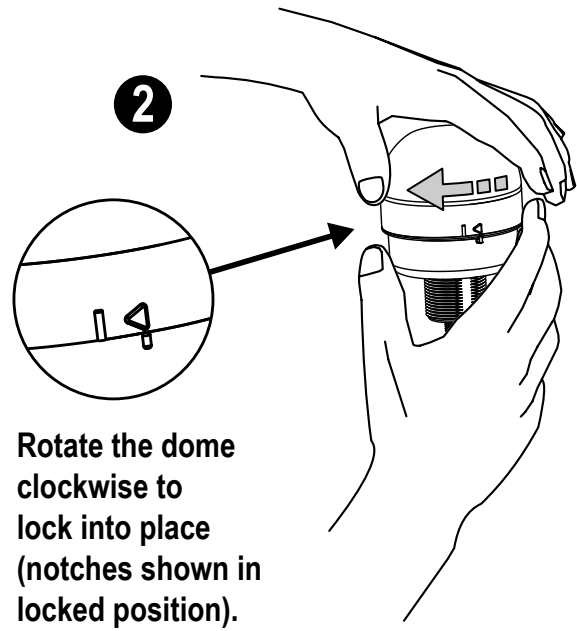
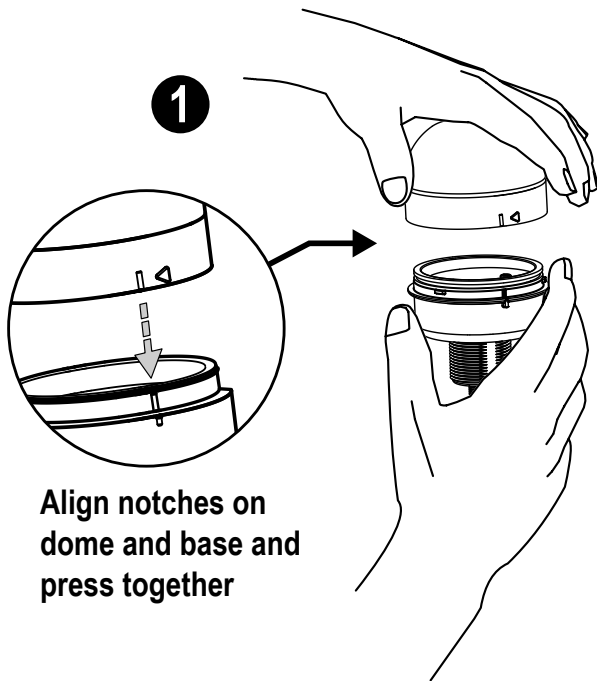

Wiring

Sourcing (PNP) Input	Euro-style Male Pinouts	Key
		<p>1 = brown 2 = white 3 = blue 4 = black 5 = gray C1 = Module 1 C2 = Module 2 C3 = Module 3</p>

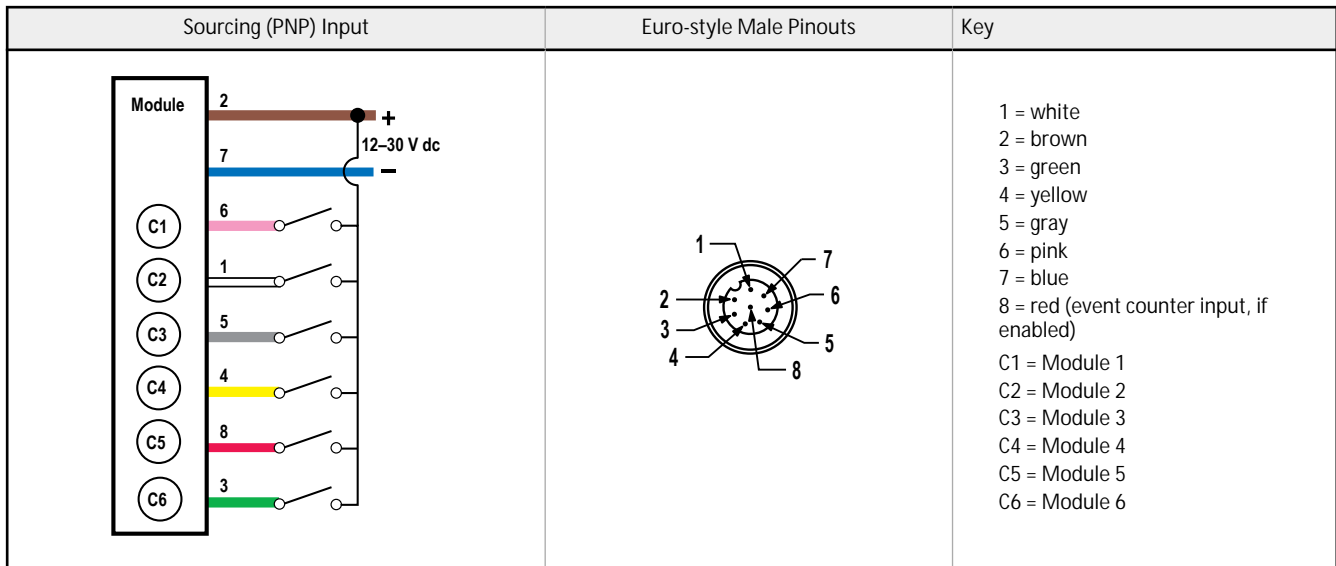

Input wires C1 through C6 can be used to either control the light segments or can be configured as external PNP Inputs. Refer to the DIP switch settings for configuration instructions.

Configuration Instructions

Set the Radio Module DIP Switches

Before applying power to the device, set the radio module's DIP switches. Default configurations are noted with (*).

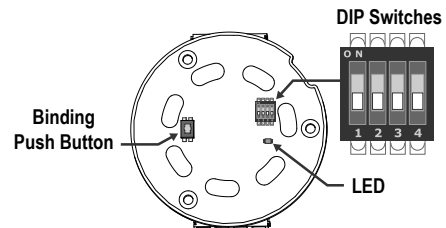

DIP Switch 1: Radio Transmit Power	900 MHz Models	2.4 GHz Models
OFF *	1 Watt (30 dBm) operation	Disabled
ON	250 mW (24 dBm) operation	

The 900 MHz radios transmit at 1 Watt (30 dBm) or 250 mW (24 dBm). While the Performance radios operate in 1 Watt mode, they cannot communicate with the older 150 mW radios. To communicate with 150 mW radios, operate this radio in 250 mW mode. For 2.4 GHz models, this DIP switch is disabled. The transmit power for 2.4 GHz is fixed at about 65 mW EIRP (18 dBm), making the 2.4 GHz Performance models automatically compatible with older 2.4 GHz models.

DIP Switch 2: Input Wires	900 MHz Models and 2.4 GHz Models
OFF *	Input wires control lights
ON	Disables wired input control of lights and converts wires to auxiliary Inputs

If there are no lights at the end of the input wires to turn on, the inputs still function as a sourcing input.

DIP Switch 3: Event Counter	900 MHz Models and 2.4 GHz Models
OFF *	Default I/O operation
ON	Configure input 5 as a 32-bit synchronous counter at a maximum frequency of 20 Hz; disable input 6 (the counter requires two registers)

The event counter is active for RF firmware revision 5.3 or higher. In the default position (OFF), the input 1 through 6 control the tower lights. When DIP switch 3 is ON, input 5 wire is the counter input and input 6 wire is disabled. Registers 5 and 6 store the 32-bit synchronous counter count. Inputs 5 and 6 are independent from the lights and will not drive any lights they are wired to. Input wires 1 through 4 function normally.

DIP Switch 4: Bit Packing I/O	900 MHz Models and 2.4 GHz Models
OFF *	Default I/O operation
ON	Bit-packed I/O with all inputs in Modbus register 1 and all outputs in Modbus register 9. All other Modbus registers are disabled.

Bit packing is active for RF firmware revision 5.8 or higher. Bit packing uses a single register, or range of contiguous registers, to represent I/O values. This allows you to read or write multiple I/O values with a single Modbus message. Input 1 is stored in the least significant bit of register 1. Output 1 is stored in the least significant bit of register 9.

Event Counter

To use the event counter, the measured (logic high) signal must be greater than or equal to 25 ms. The 32-bit count is stored in I/O registers 5 and 6.

To zero out (clear) the event counter,

- Map an input/button on a Gateway to Node register 14 to clear the counter when the input/button is activated; or
- From a host system, write a 1 (the output must transition from a zero to a one to reset the counter) to Node register 14 or write a 5424 (0x1530) to Node control register 15.

RF firmware revision 5.3 or higher is required to use this feature.

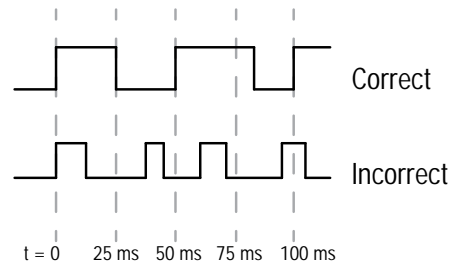

Bind the K70 to the Gateway and Assign the Node Address

Before beginning the binding procedure, apply power to all the devices.

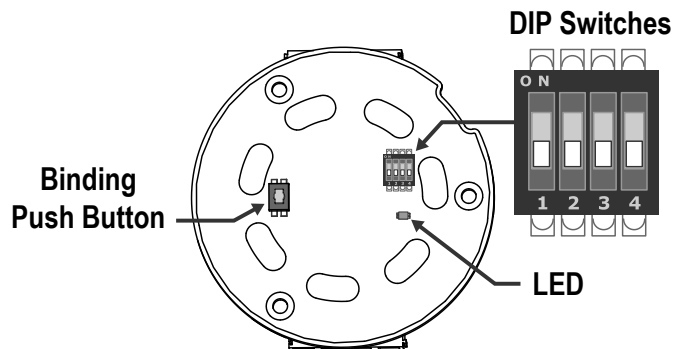

1. Enter binding mode on the Gateway.

- For board modules, triple-click the button.
- For housed models, triple-click button 2.

On the board modules, the green/red LED flashes. On the housed models, both LEDs flash red.

2. Assign the K70 a Node address using the Gateway's rotary dials. Use the left rotary dial for the left digit and the right rotary dial for the right digit. For example, to assign your K70 to Node 01, set the left dial to 0 and the right dial to 1.

Valid Node addresses are 01 through 47.

3. Remove any components to access the circuit board in the base module of the K70.

4. Enter binding mode on the K70 by triple-clicking the button.

The bicolored LED flashes alternately while it searches for a Gateway in binding mode. After the K70 is bound, the LED is red and green for four seconds (looks amber), then it flashes four times (looks amber). The K70 automatically exits binding mode, cycles power, and enters Run mode.

5. Write the Node address on the provided label.

This makes it easier to identify the physical Node location within a multi-Node network.

6. Reassemble the components back onto the base.
7. Repeat steps 2 through 5 for as many K70 Wireless Indicator Lights as are needed for your network.
8. After binding all K70s, exit binding mode on the Gateway.
 - For board modules, double-click the button.
 - For housed models, double-click button 2.

LED Behavior for the Nodes

Nodes do not sample inputs until they are communicating with the Gateway. The radios and antennas must be a minimum distance apart to function properly. Recommended minimum distances are:

- 900 MHz 150 mW and 250 mW radios: 6 feet
- 900 MHz 1 Watt radios: 15 feet
- 2.4 GHz 65 mW radios: 1 foot

LED (Bi-color)	Node Status
Flashing green	Radio link okay
Green and red flashing alternately	In Binding mode
Both colors are solid for 4 seconds, then flash 4 times; looks amber	Binding mode is complete
Flashing red, once every 3 seconds	Radio link error
Flashing red, once every second	Device error

Modes of Operation

Node Controlled. The wireless K70 Node can be operated similar to a wired model where the individual segments are activated by a PLC or manual switch. In this scenario, the Gateway only monitors the status of the light segments. An example application would be remotely monitoring the status of one or multiple machines from a single Gateway.

Gateway Controlled. In the Gateway-controlled mode, the K70 Node only requires 10 to 30 V dc power. Input signals sent from the Gateway have full control over the status of all the segments. An example application would be a call-for-parts application with a K70 Node mounted to a fork truck and the Gateway mounted in a work cell or stock room. When part pick-up or delivery is needed, the operator sends a signal to the fork truck driver. A multicolor K70 could be used when there are multiple pick-up or delivery locations.

Sure Cross® User Configuration Tool

The User Configuration Tool (UCT) offers an easy way to link I/O points in your wireless network, view I/O register values, and set system communication parameters when a host system is not part of the wireless network. The software runs on any computer with the Windows Vista, Windows 7, Windows 8, or Windows 10 operating system.

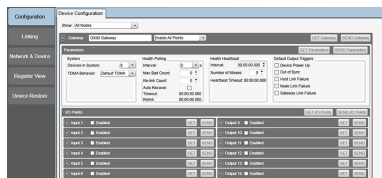

Use a USB to RS-485 adapter cable to connect a standalone DX80 Gateway to the computer. For DXM Controllers with an internal DX80 radio, connect a computer to the DXM Controller using a USB or Ethernet connection. Download the most recent revisions of the UCT software from Banner Engineering's website: www.bannerengineering.com/wireless.

The USB to RS-485 adapter cable is not required for the DXM Controller. For standalone DX80 Gateway devices use:

- USB to RS-485 adapter cable model BWA-UCT-900 for 1 Watt radios
- USB to RS-485 adapter cable model BWA-HW-006 for all other radios

Creating Flash Patterns

Use the User Configuration Tool (UCT) to set the Duty Cycle, For Outputs of Node 1, output 9, to 0x0F0F as shown below, to achieve this flash pattern.

Flash a K70 light by entering a time-based bit mask into the Duty Cycle parameter for that output register. Bit 0 represents the first 62.5 ms time window, bit 1 represents the second 62.5 ms window, etc.

For example, turn ON the output from 0 to 250 ms, OFF from 250 to 500 ms, ON from 500 to 750 ms, then OFF again from 750 ms to 1 second by writing 0x0F0F to the appropriate output.

Bit	15	14	13	12	11	10	9	8	7	6	5	4	3	2	1	0
Bin	0	0	0	0	1	1	1	1	0	0	0	0	1	1	1	1
Hex	0				F				0				F			
Light	Turned off from 750 ms to 1 s				Turned on from 500 to 750 ms				Turned off from 250 to 500 ms				Turned on from 0 to 250 ms			

This example shows 0F0F being written to the Duty Cycle, For Outputs parameter for Node 1, output 9.

Device Parameters

Show Value as: Integer Hexadecimal

Get
Send

Device	I/O Number	Parameter	Value
Node 1	9	Duty Cycle, For Outputs	F0F

Duty Cycle (Outputs only) (bits 15:0). This parameter defines the proportion of time the output is active. Using the 16-bit field, each "on" bit represents 1/16 seconds. For example, 0000 0000 0000 1111 (0x000F) sets the duty cycle to 1/4 seconds; 0000 0000 0000 0011 (0x0003) sets the duty cycle to 1/8 seconds. (Parameter number 0x04).

Supported in Gateway RF Firmware Version 2.7 and above.
 Supported in Node RF Firmware Version 1.0 and above.

Modbus Registers

I/O	Modbus Holding Register		I/O Type	I/O Range		Holding Register Representation (Dec.)		Color #
	Gateway	Any Node		Min.	Max.	Min.	Max.	
1	1	1 + (Node# × 16)	Discrete IN 1 / Bit-packed inputs	0	1	0	1	C1
2	2	2 + (Node# × 16)	Discrete IN 2	0	1	0	1	C2
3	3	3 + (Node# × 16)	Discrete IN 3	0	1	0	1	C3
4	4	4 + (Node# × 16)	Discrete IN 4	0	1	0	1	C4
5	5	5 + (Node# × 16)	Discrete IN 5 / 32-bit event counter high word	0	1	0	1	C5
6	6	6 + (Node# × 16)	Discrete IN 6 / 32-bit event counter low word	0	1	0	1	-
7	7	7 + (Node# × 16)	Reserved					
8	8	8 + (Node# × 16)	Device Message					
9	9	9 + (Node# × 16)	Discrete OUT 9 / Bit-picked outputs	0	1	0	1	C1
10	10	10 + (Node# × 16)	Discrete OUT 10	0	1	0	1	C2
11	11	11 + (Node# × 16)	Discrete OUT 11	0	1	0	1	C3
12	12	12 + (Node# × 16)	Discrete OUT 12	0	1	0	1	C4
13	13	13 + (Node# × 16)	Discrete OUT 13	0	1	0	1	C5
14	14	14 + (Node# × 16)	Discrete OUT 14 / Zero out (clear) the counter	0	1	0	1	-
15	15	15 + (Node# × 16)	Control Message					
16	16	16 + (Node# × 16)	Reserved					

Use the User Configuration Tool (UCT) software to define unique synchronous flash patterns for the lights.

Specifications

EZ-LIGHT K70

Supply Voltage and Current

12 to 30 V dc (Outside the USA: 12 V dc to 24 V dc, $\pm 10\%$) [¶]

Indicators - Maximum current per LED color:

Blue, Green, White: 200 mA at 12 V dc; 90 mA at 30 V dc

Red, Yellow: 150 mA at 12 V dc; 75 mA at 30 V dc

900 MHz Consumption: Maximum current draw is < 40 mA and typical current draw is < 30 mA at 24 V dc. (2.4 GHz consumption is less.)

Supply Protection Circuitry

Protected against transient voltages

Indicator Response Time

Off Response: 150 μ s (maximum) at 12 to 30 V dc

On Response: 180 ms (maximum) at 12 V dc; 50 ms (maximum) at 30 V dc

Construction

Base and cover: polycarbonate

Operating Conditions

-40 °C to +50 °C (-40 °F to +122 °F)

95% at +50 °C maximum relative humidity (non-condensing)

Environmental Rating

IEC IP65

Vibration and Mechanical Shock

Vibration 10 Hz to 55 Hz 0.5 mm p-p amplitude per IEC 60068-2-6

Shock 15G 11 ms duration, half sine wave per IEC 60068-2-27

Certifications



Segment Lumens

Color	Typical Wavelength or Color Temp	Typical Intensity (lm)
Green	525 nm	65
Red	625 nm	34
Yellow	590 nm	22
Blue	470 nm	22
White	5000 K	87

Indicators

1 to 5 colors depending on model: Green, Red, Yellow, Blue, and White

Connections

5-pin M12/Euro-style quick disconnect, 8-pin M12/Euro-style quick disconnect, 150 mm (5.9 in) PVC cable with an M12/Euro-style quick disconnect, or 2 m (6.5 ft) unterminated cable, depending on model

Required Overcurrent Protection



WARNING: Electrical connections must be made by qualified personnel in accordance with local and national electrical codes and regulations.

Overcurrent protection is required to be provided by end product application per the supplied table.

Overcurrent protection may be provided with external fusing or via Current Limiting, Class 2 Power Supply.

Supply wiring leads < 24 AWG shall not be spliced.

For additional product support, go to www.bannerengineering.com.

Supply Wiring (AWG)	Required Overcurrent Protection (Amps)
20	5.0
22	3.0
24	2.0
26	1.0
28	0.8
30	0.5

Radio

Radio Range

900 MHz, 1 Watt (Internal antenna): Up to 3.2 km (2 miles)

2.4 GHz, 65 mW (Internal antenna): Up to 1000 m (3280 ft) with line of sight

Minimum Separation Distance

900 MHz, 1 Watt: 4.57 m (15 ft)

2.4 GHz, 65 mW: 0.3 m (1 ft)

Spread Spectrum Technology

FHSS (Frequency Hopping Spread Spectrum)

900 MHz Compliance (1 Watt)

FCC ID UE3RM1809: This device complies with FCC Part 15, Subpart C, 15.247

IC: 7044A-RM1809

2.4 GHz Compliance

FCC ID UE300DX80-2400 - This device complies with FCC Part 15, Subpart C, 15.247

ETSI EN 300 328 V1.8.1 (2012-06)

IC: 7044A-DX8024

Radiated Immunity HF

10 V/m (EN 61000-4-3)

Link Timeout

Gateway: Configurable via User Configuration Tool (UCT) software

Node: Defined by Gateway

[¶] For European applications, power this device from a Limited Power Source as defined in EN 60950-1.

Dimensions

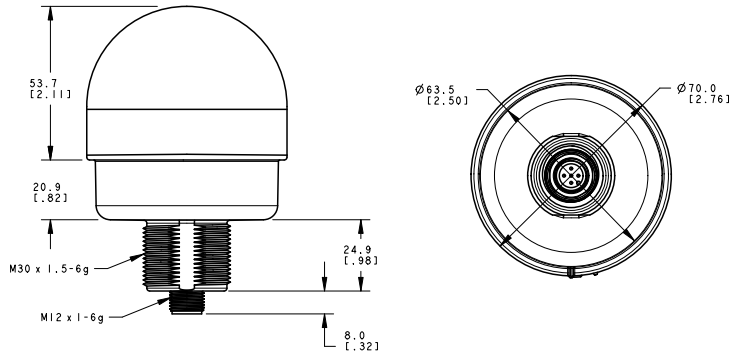

All measurements are listed in millimeters [inches], unless noted otherwise. Dimensions for the quick disconnect model are shown.

Accessories

Cordsets

5-Pin Threaded M12/Euro-Style Cordsets—Single Ended				
Model	Length	Style	Dimensions	Pinout (Female)
MQDC1-501.5	0.50 m (1.5 ft)	Straight		
MQDC1-506	1.83 m (6 ft)			
MQDC1-515	4.57 m (15 ft)			
MQDC1-530	9.14 m (30 ft)			
MQDC1-506RA	1.83 m (6 ft)	Right-Angle		
MQDC1-515RA	4.57 m (15 ft)			
MQDC1-530RA	9.14 m (30 ft)			

8-Pin Threaded M12/Euro-Style Cordsets with Open-Shield				
Model	Length	Style	Dimensions	Pinout (Female)
MQDC2S-806	1.83 m (6 ft)	Straight		
MQDC2S-815	4.57 m (15 ft)			
MQDC2S-830	9.14 m (30 ft)			
MQDC2S-850	15.2 m (50 ft)			

8-Pin Threaded M12/Euro-Style Cordsets with Open-Shield				
Model	Length	Style	Dimensions	Pinout (Female)
MQDC2S-806RA	1.83 m (6 ft)	Right-Angle		
MQDC2S-815RA	4.57 m (15 ft)			
MQDC2S-830RA	9.14 m (30 ft)			
MQDC2S-850RA	15.2 m (50 ft)			

All measurements are listed in millimeters, unless noted otherwise.

Mounting Brackets

SMB30A

- Right-angle bracket with curved slot for versatile orientation
- Clearance for M6 (¼ in) hardware
- Mounting hole for 30 mm sensor
- 12-ga. stainless steel

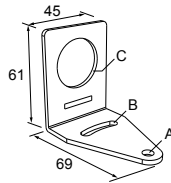

Hole center spacing: A to B=40
Hole size: A=ø 6.3, B= 27.1 x 6.3, C=ø 30.5

SMB30MM

- 12-ga. stainless steel bracket with curved mounting slots for versatile orientation
- Clearance for M6 (¼ in) hardware
- Mounting hole for 30 mm sensor

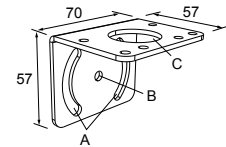

Hole center spacing: A = 51, A to B = 25.4
Hole size: A = 42.6 x 7, B = ø 6.4, C = ø 30.1

SMBAMS30P

- Flat SMBAMS series bracket
- 30 mm hole for mounting sensors
- Articulation slots for 90°+ rotation
- 12-ga. 300 series stainless steel

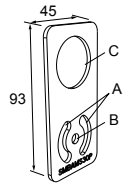

Hole center spacing: A=26.0, A to B=13.0
Hole size: A=26.8 x 7.0, B=ø 6.5, C=ø 31.0

SSA-MBK-EEC1

- Single 30 mm hole
- 8 gauge steel, black finish (powder coat)
- Front surface for customer applied labels

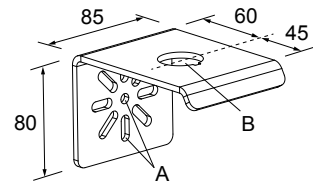

Hole size: A = ø 7, B = ø 30

All measurements are listed in millimeters, unless noted otherwise.

Elevated Mount System

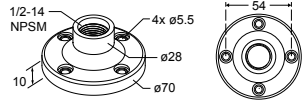

Model	Features		Components
SA-M30 - Black Polycarbonate	<ul style="list-style-type: none"> • Streamlined black PC or Gray PC thread cover • Covers M30 thread on the light base • Mounting hardware included 		
SA-M30C - Gray Polycarbonate			
Polished 304 Stainless Steel	Black Anodized Aluminum	Clear Anodized Aluminum	<ul style="list-style-type: none"> • Elevated-use stand-off pipe (½ in. NPSM/DN15) • Polished 304 stainless steel, black anodized aluminum, or clear anodized aluminum surface • ½ in. NPT thread at both ends • Compatible with most industrial environments
SOP-E12-150SS 150 mm (6 in) long	SOP-E12-150A 150 mm (6 in) long	SOP-E12-150AC 150 mm (6 in) long	
SOP-E12-300SS 300 mm (12 in) long	SOP-E12-300A 300 mm (12 in) long	SOP-E12-300AC 300 mm (12 in) long	
SOP-E12-900SS 900 mm (36 in) long	SOP-E12-900A 900 mm (36 in) long	SOP-E12-900AC 900 mm (36 in) long	

Model	Features	Components
SA-E12M30 - Black Acetal	<ul style="list-style-type: none"> Streamlined black acetal or white UHMW mounting base adapter/cover Connects between ½ in. NPSM/DN15 pipe and 30 mm (1-3/16 in) drilled hole Mounting hardware included 	
SA-E12M30C - White UHMW		

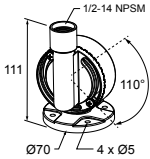
Pipe Mounting Flange			
Model	Features	Construction	
SA-F12	<ul style="list-style-type: none"> For use elevated stand-off pipes (½ in, NPSM/DN15) M5 mounting hardware and nitrile gasket included 	Die-cast zinc base with black paint	

Foldable Mounting Brackets			
Model	Features	Construction	
SA-FFB12	<ul style="list-style-type: none"> For use with 1/2 inch stand-off pipes Stainless steel hardware 	Black polycarbonate	
SA-FFB12C		Gray polycarbonate	

LMB Sealed Right-Angle Brackets

Model	Description	Construction	
LMB30RA	Direct-Mount Models: Bracket kit with base, 30 mm adapter, set screw, fasteners, o-rings, and gaskets	Black polycarbonate	
LMB30RAC		Gray polycarbonate	
LMBE12RA	Pipe-Mount Models: Bracket kit with base, ½-14 pipe adapter, set screw, fasteners, o-rings, and gaskets. For use with stand-off pipe (listed and sold separately)	Black polycarbonate	
LMBE12RAC		Gray polycarbonate	

Banner Engineering Corp. Limited Warranty

Banner Engineering Corp. warrants its products to be free from defects in material and workmanship for one year following the date of shipment. Banner Engineering Corp. will repair or replace, free of charge, any product of its manufacture which, at the time it is returned to the factory, is found to have been defective during the warranty period. This warranty does not cover damage or liability for misuse, abuse, or the improper application or installation of the Banner product.

THIS LIMITED WARRANTY IS EXCLUSIVE AND IN LIEU OF ALL OTHER WARRANTIES WHETHER EXPRESS OR IMPLIED (INCLUDING, WITHOUT LIMITATION, ANY WARRANTY OF MERCHANTABILITY OR FITNESS FOR A PARTICULAR PURPOSE), AND WHETHER ARISING UNDER COURSE OF PERFORMANCE, COURSE OF DEALING OR TRADE USAGE.

This Warranty is exclusive and limited to repair or, at the discretion of Banner Engineering Corp., replacement. IN NO EVENT SHALL BANNER ENGINEERING CORP. BE LIABLE TO BUYER OR ANY OTHER PERSON OR ENTITY FOR ANY EXTRA COSTS, EXPENSES, LOSSES, LOSS OF PROFITS, OR ANY INCIDENTAL, CONSEQUENTIAL OR SPECIAL DAMAGES RESULTING FROM ANY PRODUCT DEFECT OR FROM THE USE OR INABILITY TO USE THE PRODUCT, WHETHER ARISING IN CONTRACT OR WARRANTY, STATUTE, TORT, STRICT LIABILITY, NEGLIGENCE, OR OTHERWISE.

Banner Engineering Corp. reserves the right to change, modify or improve the design of the product without assuming any obligations or liabilities relating to any product previously manufactured by Banner Engineering Corp. Any misuse, abuse, or improper application or installation of this product or use of the product for personal protection applications when the product is identified as not intended for such purposes will void the product warranty. Any modifications to this product without prior express approval by Banner Engineering Corp will void the product warranties. All specifications published in this document are subject to change: Banner reserves the right to modify product specifications or update documentation at any time. Specifications and product information in English supersede that which is provided in any other language. For the most recent version of any documentation, refer to:

www.bannerengineering.com.