



Safety Solutions





EZ-SCREEN Series Safety Light Screens

- Intuitive diagnostics simplify setup, facilitate troubleshooting and streamline installation
- No blind zone design provides end-to-end sensing to eliminate gaps in detection
- Metal end caps, sturdy aluminium housing and a recessed window to avoid damage from impact
- Standard pairs, cascade systems, versions with integrated muting and extensive accessories to suit a wide variety of safeguarding configurations
- Type 4 and Type 2 versions available

XS26-2 Expandable Safety Controller

- Up to eight expansion I/O modules can be added as your safety application grows or changes
- Configuration software is so simple that you will be programming in minutes
- Simulator functionality allows users to test their configurations without being connected to a controller

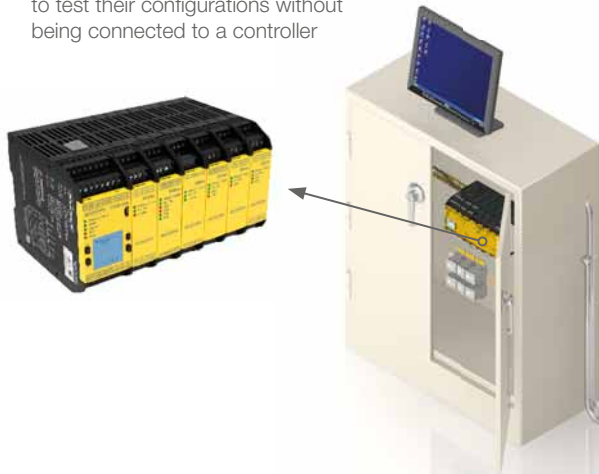

Two-Hand Control

- Ergonomic design, avoids risk of repetitive strain injury
- Optional run bar stand
- Meets highest safety category
- Add EZ-LIGHTS for status indication in lean manufacturing



K90 Series Large Multicolour EZ-LIGHT

- Large, 90 mm indicator lights provide extremely bright and uniform illumination from all directions and longer distances
- Up to five colours in one device
- Rugged IP67 design

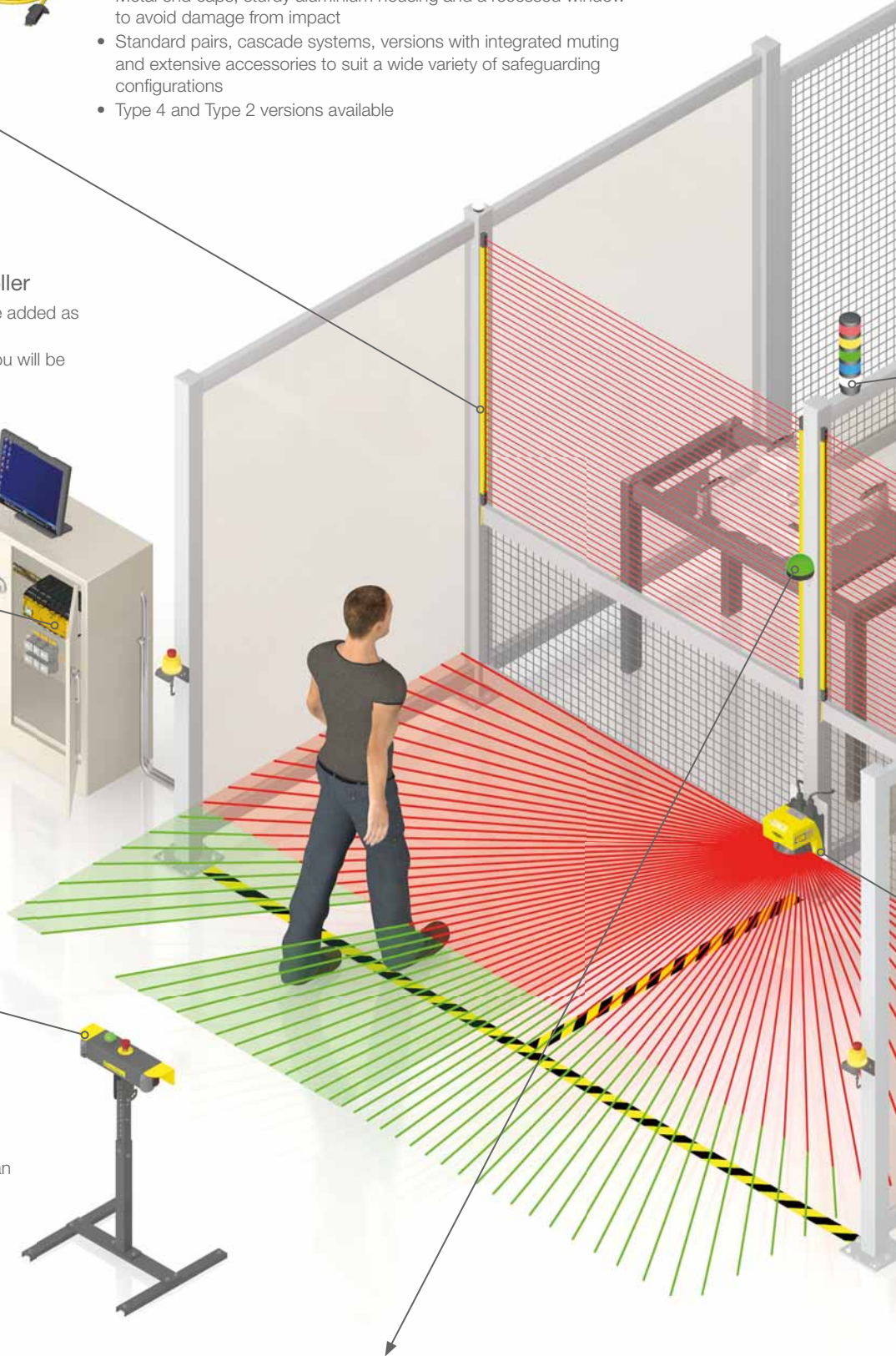

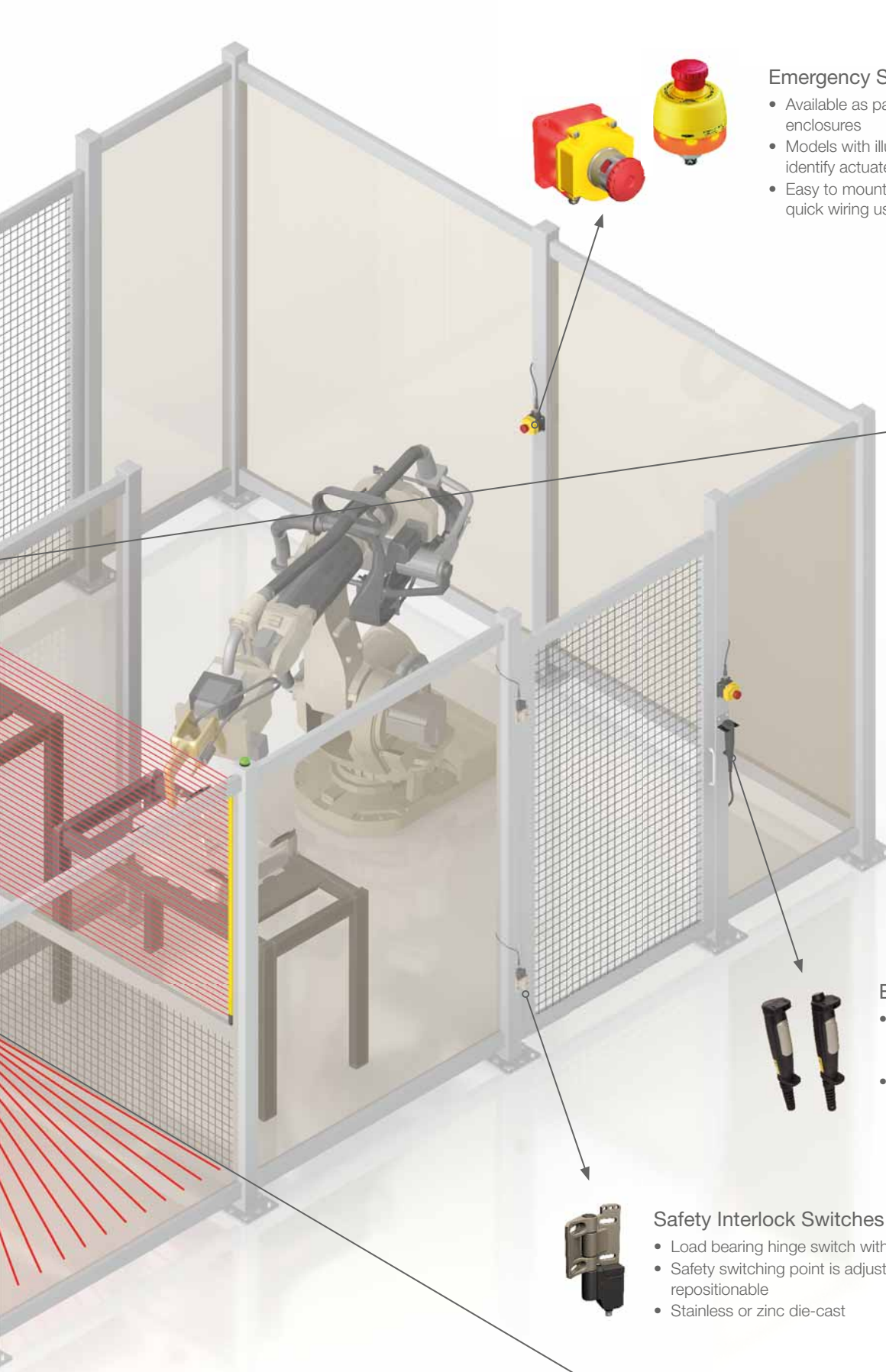

Emergency Stop and Stop Control

- Available as panel mount, or as pre-assembled enclosures
- Models with illumination help operators to quickly identify actuated buttons
- Easy to mount enclosures with error free and quick wiring using M12 cables



TL70 Modular LED Tower Light

- Up to five colours plus audible in one device
- Bright, uniform indicator segments that are colour neutral when switched OFF

Enabling Devices

- Provides safety function when user either squeezes or releases the handle grip switch
- Ergonomic design with a detented enable position



Safety Interlock Switches

- Load bearing hinge switch with 270° range
- Safety switching point is adjustable and repositionable
- Stainless or zinc die-cast



Safety Scanner

- Two-dimensional laser scanner with easy-to-use software
- Programming of irregular shaped warning and detection zones
- 190° scanning angle with selectable resolutions (30 mm, 40 mm, 50 mm, 70 mm and 150 mm) and a 4 m or 6.25 m range



(Expandable) Safety Controller

Cat 4 PLe (EN ISO 13849), SIL 3 (IEC 61508), SIL CL 3 (IEC 62061)
 Add up to 8 expansion I/O modules – choose from 6 expansion modules



	Model (24 VDC)	Description	Housing	Inputs/ Convertible	Safety Outputs
CONTROLLER	SC26-2, e, d & de	Programmable Controller, non-expandable	45 mm	26/8	2 Dual Channel PNP 0.5 A @ 24 VDC
	XS26-2, e, d & de	Programmable Controller, expandable	45 mm	26/8	2 Dual Channel PNP 0.5 A @ 24 VDC
EXPANSION MODULES	XS8si	Safety Input Module	22.5 mm	8/2	/
	XS16si	Safety Input Module	22.5 mm	16/4	/
	XS2so	Safety Output Module	22.5 mm	/	2 Dual Channel PNP 0.75 A @ 24 VDC
	XS4so	Safety Output Module	22.5 mm	/	4 Dual Channel PNP 0.5 A @ 24 VDC
	XS1ro	Safety Relay Output Module	22.5 mm	/	2 NO: 6 A 250 VAC/DC 1 NC: 2.5 A 150 VAC/DC
	XS2ro	Safety Relay Output Module	22.5 mm	/	4 NO: 6 A 250 VAC/DC 2 NC: 2.5 A 150 VAC/DC

Accessories

Model	Description
SC-XM2	Memory Card
SC-XMP2	Programming Tool
SC-TC2	Spring Terminal Block Set
SC-USB2	USB Cable



Build System and Select Equipment

1. Add up to 8 modules

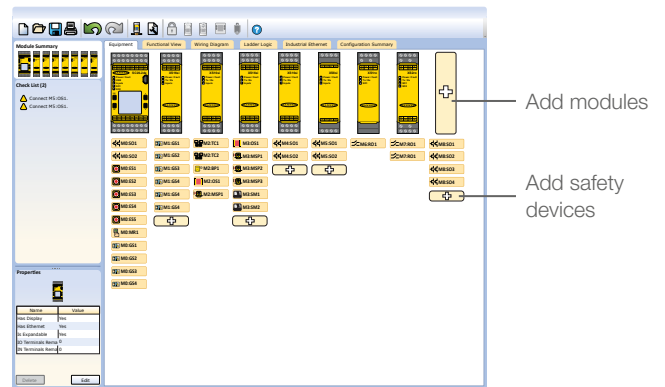
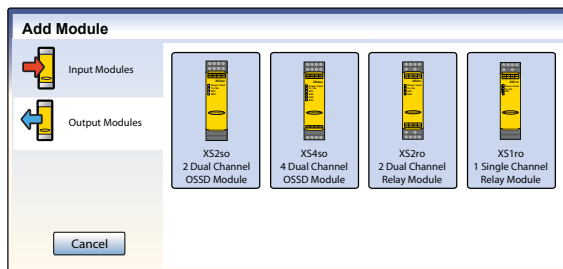

2. Add safety devices



3. Select safety device properties

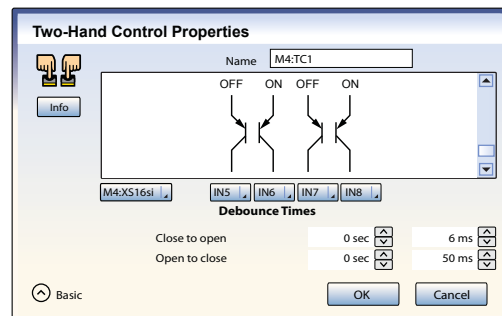

Start using the software today, go to bannerengineering.com/XS26-2



Configure Your System in Minutes

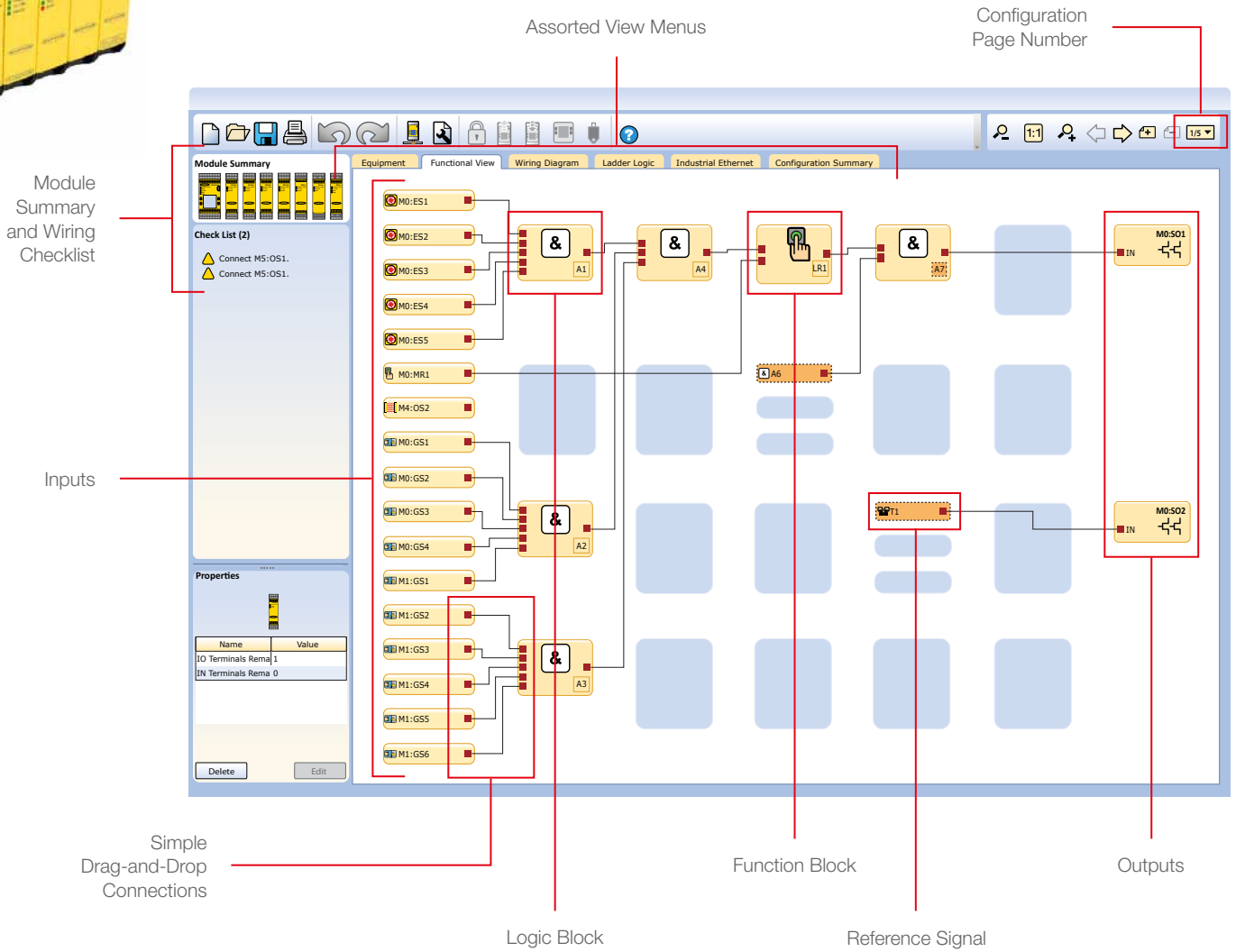

Wiring Diagram

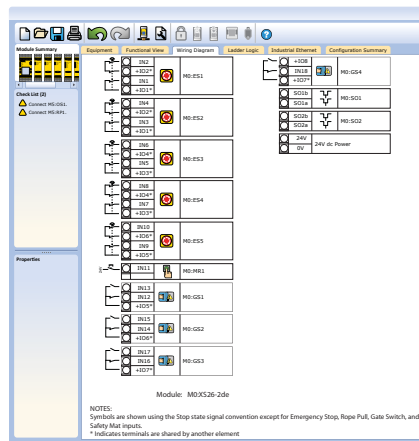

Wiring Diagram in Live Mode

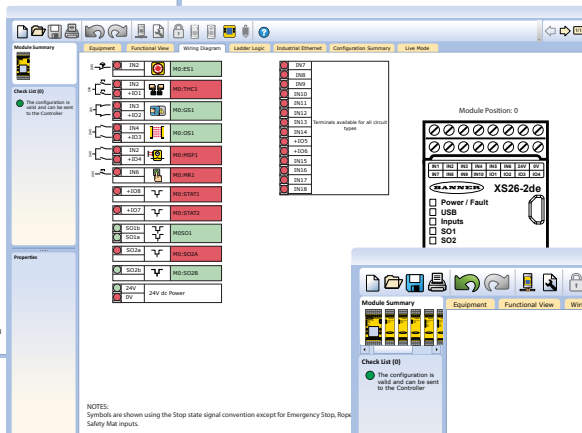

Ladder Logic

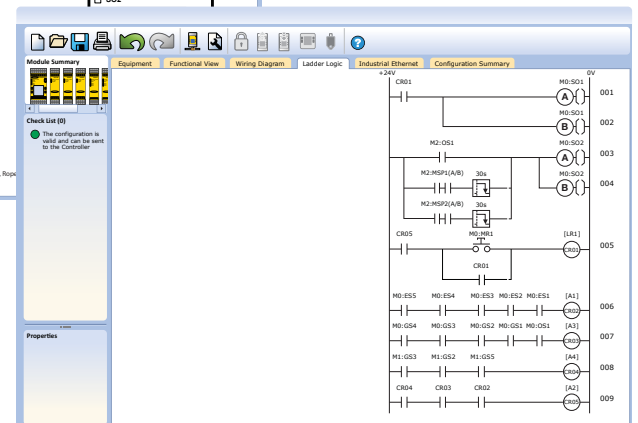

Choosing your EZ-SCREEN Model

EZ-SCREEN LS

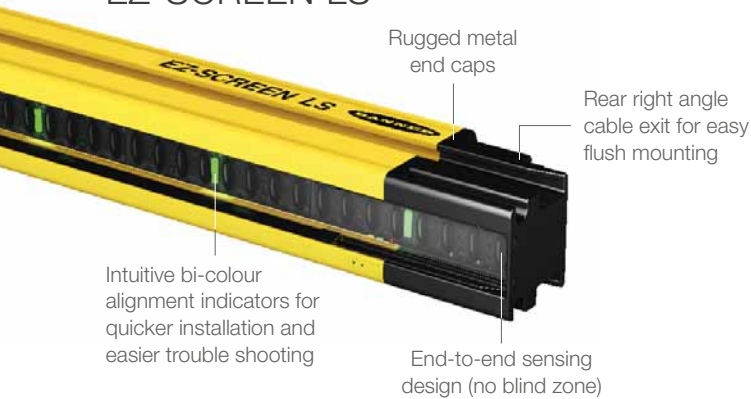

Simple, Rugged Safety Light Screen with Enhanced Features

- Type 4 per IEC 61496-1, -2; Category 4 PLe per EN ISO 13849-1; SIL 3 per IEC 61508; SIL CL 3 per IEC 62061
- 14 mm, 23 mm or 40 mm detection capability
- Defined area from 280 to 1820 mm in 70 mm increments with detection ranges up to 12 m
- Intuitive alignment indicators along the entire length of the receiver
- Standard pairs, cascade systems and extensive accessories to suit a wide variety of safeguarding configurations
- Recessed window for additional protection
- Heavy-duty housing 36 x 45 mm

EZ-SCREEN LP (Low Profile)



Compact design and flexible mounting options deliver an exact fit with no blind zone

- Type 4 per IEC 61496-1, -2; Category 4 PLe per EN ISO 13849-1; SIL 3 per IEC 61508; SIL CL 3 per IEC 62061
- 14 mm or 25 mm detection capability
- Defined areas from 270 to 1810 mm in 140 mm increments with detection ranges up to 7 m
- Standard, cascade and integrated muting models available
- Compact 26 x 28 mm housing

EZ-SCREEN Standard

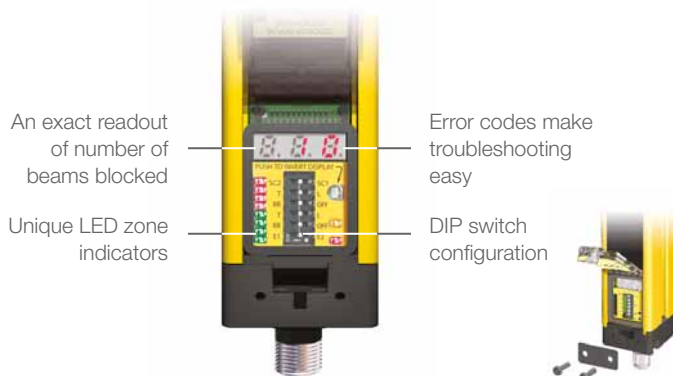

Easy alignment and maintenance saves you setup time and troubleshooting

- Type 4 per IEC 61496-1, -2; Category 4 PLe, per EN ISO 13849-1; SIL 3 per IEC 61508; SIL CL 3 per IEC 62061
- 14 mm or 30 mm detection capability
- Defined area from 150 to 2400 mm in 150 mm increments with detection ranges up to 18 m
- Superior optical design and finely focused $\pm 2.5^\circ$ beam make systems extremely easy to align and maintain
- Cascading models allow up to four systems of any length and resolution to be wired together to form a single safety device
- Heavy-duty housing, 35 x 45 mm

EZ-SCREEN Type 2



Compact optical safeguarding solution designed for lower-risk applications where risk of injury is limited but some guarding is necessary

- Type 2 per IEC 61496-1, -2; Category 2 PLc per EN ISO 13849-1
- Offered with 30 mm resolution and 15 m range
- Available in trip (auto reset) or latch (manual reset) models
- Offers optional lens shields and enclosures for added durability
- Compact 25 x 32 mm housing

Introducing the EZ-SCREEN LS Safety Light Screen

Intuitive, easy-to-use safety light screen for safeguarding machines and automated equipment in challenging environments

- Trip output (automatic reset) allows easy interfacing to safety modules, safety controllers, and safety PES/PLCs
- External Device Monitoring (EDM), fault output, and scan code select available on some models
- Dual scan technology makes the sensor highly immune to EMI, RFI, ambient light, weld flash, and strobe light
- Remote fixed blanking available on cascade models allows for greater flexibility in dynamic applications
- Addition of remote or integrated indication lights on cascade models provides clear communication of system status
- Interconnection of E-Stop or Guard Interlocking Switches available on cascadable models

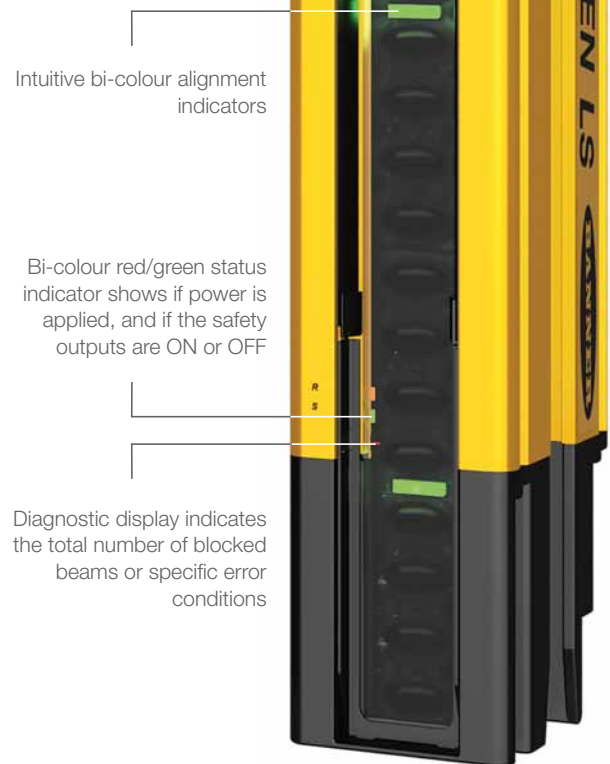

Available in Three Resolutions

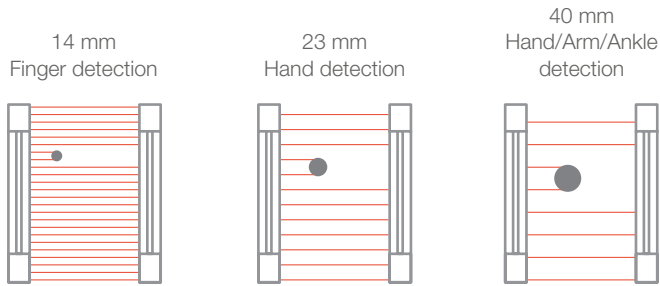

Heavy-duty

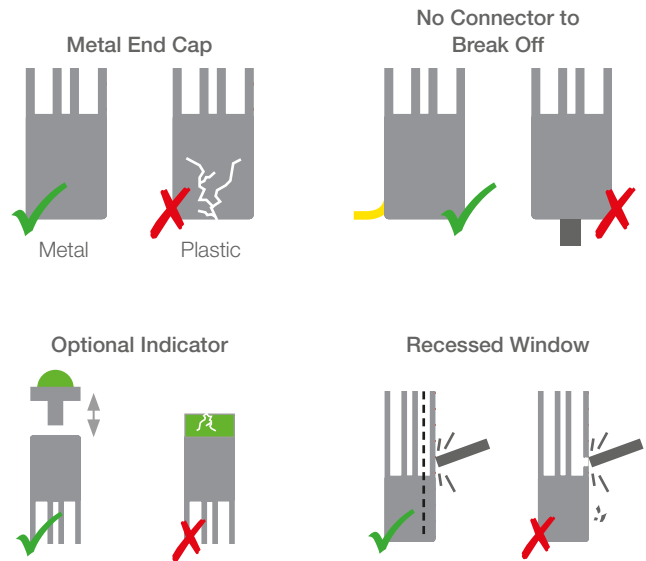

	Max Sensing Range	Defined Area	Safety Rating	Dimensions (H x W x D) (H varies by model)	Environmental Rating	DIP Switches
EZ-SCREEN LS	12 m	280 to 1820 mm	Type 4 / Cat 4 PLe	36 x 45 mm	IP65, IP67	No
EZ-SCREEN LP	7 m	270 to 1810 mm	Type 4 / Cat 4 PLe	26 x 28 mm	IP65	Yes
EZ-SCREEN Standard	14 mm: 6 m 30 mm: 18 m	150 to 1800 mm 150 to 2400 mm	Type 4 / Cat 4 PLe	35 x 45 mm	IP65	Yes
EZ-SCREEN Type 2	15 m	150 to 1800 mm	Type 2 / Cat 2 PLc	25 x 32 mm	IP65	No



EZ-SCREEN LS – Standard

Type 4, Cat 4 PLe, SIL 3, SIL CL 3 – Finger, hand and ankle detection
 2 PNP Safety Outputs (OSSD) and 1 auxiliary output (CSSI) (8-pin models only), 24 VDC power supply

Family	System Type	Resolution	Defined Area	Connection*
SLL	P	14	770	P88
	E = Emitter only R = Receiver only P = Pair (Emitter and Receiver)	14 = 14 mm 23 = 23 mm 40 = 40 mm	280 = 280 mm 350 = 350 mm 420 = 420 mm 490 = 490 mm 560 = 560 mm 630 = 630 mm 700 = 700 mm 770 = 770 mm 840 = 840 mm 910 = 910 mm 980 = 980 mm	1050 = 1050 mm 1120 = 1120 mm 1190 = 1190 mm 1260 = 1260 mm 1330 = 1330 mm 1400 = 1400 mm 1470 = 1470 mm 1540 = 1540 mm 1610 = 1610 mm 1680 = 1680 mm 1750 = 1750 mm 1820 = 1820 mm

P8 = 300 mm pigtail, 8-Pin M12 QD (individual Emitter or Receiver models)
P88 = 300 mm pigtail, 8-Pin M12 QD (on both Emitter and Receiver models)
Blank = no pigtail, RD connection (for RDLS-8..D cordset)
 *5-pin M12 QD options available (P5 or P55)



Cordsets

Length	RD (Remote Disconnect)
4.6 m	RDLS-815D
8 m	RDLS-825D
15.3 m	RDLS-850D

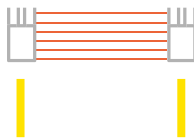

SLLP... with RDLS-8..D



Cordsets

Length	8-Pin M12
4.5 m	QDE-815D
7.6 m	QDE-825D
15.2 m	QDE-850D
22.8 m	QDE-875D
30.4 m	QDE-8100D

5-pin M12 QD options available (example QDE-515D)

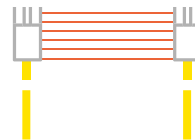

SLLP...P88 with QDE-8..D

Splitter Cordsets

Length	8-Pin Male M12 to Dual 8-Pin Female M12
No branches, no trunk	CSB-M1280M1280
0.3 m trunk 2 x 0.3 m branches	CSB-M1281M1281
2.44 m trunk 2 x 0.3 m branches	CSB-M1288M1281
4.57 m trunk 2 x 0.3 m branches	CSB-M12815M1281
7.62 m trunk 2 x 0.3 m branches	CSB-M12825M1281

Standard cordsets are yellow PVC with black overmould. For black PVC and overmould, add suffix B to the model number (example CSB-M1280M1280B)

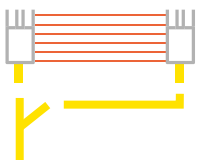

SLLP...P88 with CSB-M128..M128.. and DEE2R-8..D

Double-Ended Cordsets

Length	8-Pin M12 Double-Ended	Length	8-Pin M12 Double-Ended
0.3 m	DEE2R-81D	7.6 m	DEE2R-825D
0.9 m	DEE2R-83D	9.1 m	DEE2R-830D
2.5 m	DEE2R-88D	15.2 m	DEE2R-850D
3.6 m	DEE2R-812D	22.9 m	DEE2R-875D
4.6 m	DEE2R-815D	30.5 m	DEE2R-8100D

RD 5-pin options available (example DEE2R-51D)

EZ-SCREEN LS – Cascade

Type 4, Cat 4 PLe, SIL 3, SIL CL 3 – Finger, hand and ankle detection
 2 PNP Safety Outputs (OSSD) and 1 auxiliary output (CSSI) (8-pin models only), 24 VDC power supply

Family	Cascade	System Type	Resolution	Defined Area	Connection*	
SLL	C	P	14	770	P88	
	C = Cascade	E = Emitter only R = Receiver only P = Pair (Emitter and Receiver)	14 = 14 mm 23 = 23 mm 40 = 40 mm	350 = 350 mm 420 = 420 mm 490 = 490 mm 560 = 560 mm 630 = 630 mm 700 = 700 mm 770 = 770 mm 840 = 840 mm 910 = 910 mm 980 = 980 mm	1050 = 1050 mm 1120 = 1120 mm 1190 = 1190 mm 1260 = 1260 mm 1330 = 1330 mm 1400 = 1400 mm 1470 = 1470 mm 1540 = 1540 mm 1610 = 1610 mm 1680 = 1680 mm 1750 = 1750 mm 1820 = 1820 mm	P8 = 300 mm pigtail, 8-Pin M12 QD (first individual Emitter or Receiver models) P88 = 300 mm pigtail, 8-Pin M12 QD (first paired models) Blank = no pigtail, RD connection (for middle/end units in cascade) *5-pin M12 QD options available (P5 or P55)

Slaves

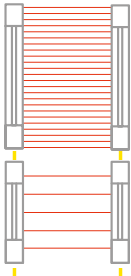

Master

Note:

- Determine the configuration of the first EZ-SCREEN LS pair (**master** connected to the machine control)
- Determine the remaining (second, third or fourth) pairs (**slaves** connected to the master using a **DELS-...** cordset)

Double-Ended RD to RD Cordsets

Length	Double-Ended RD to RD	Length	Double-Ended RD to RD
0.05 m	DELS-110E	4.6 m	DELS-1115E
0.3 m	DELS-111E	8 m	DELS-1125E
1 m	DELS-113E	15.3 m	DELS-1150E
2.5 m	DELS-118E		

Cordsets for Remote Fixed Blanking

Length	RD to 8-Pin M12
0.3 m	DELSEF-81D

Cordsets for Panel Connection

Length	8-Pin M12
3 m	PMEF-810D
M12 connector to 3 m wires, cut to length	

 SLLCP.-... with **DELS-....E** plus
 SLLCP.-... with **RDLS-8..D**

 SLLCP.-... with **DELS-....E** plus
 SLLCP.-...P88 with **QDE-8..D**

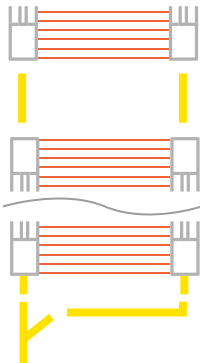
 SLLCP.-... with **DELS-....E** plus
 SLLCP.-...P88 with **CSB-M128..M128..** and **DEE2R-8..D**

EZ-SCREEN Standard

Type 4, Cat 4 PLe, SIL 3, SIL CL 3 – Finger, hand and ankle detection
2 PNP Safety Outputs (OSSD) and 1 auxiliary output, 24 VDC power supply



Dimensions		14 mm Resolution – Range 0.1 – 6 m 8-pin M12 QD		30 mm Resolution – Range 0.1 – 18 m 8-pin M12 QD	
Defined Area	Housing Length	Model Pair (E+R)	Response Time	Model Pair (E+R)	Response Time
150 mm	262 mm	SLSP14-150Q88	11 ms	SLSP30-150Q88	9 ms
300 mm	372 mm	SLSP14-300Q88	15 ms	SLSP30-300Q88	11 ms
450 mm	522 mm	SLSP14-450Q88	19 ms	SLSP30-450Q88	13 ms
600 mm	671 mm	SLSP14-600Q88	23 ms	SLSP30-600Q88	15 ms
750 mm	821 mm	SLSP14-750Q88	27 ms	SLSP30-750Q88	17 ms
900 mm	971 mm	SLSP14-900Q88	32 ms	SLSP30-900Q88	19 ms
1050 mm	1120 mm	SLSP14-1050Q88	36 ms	SLSP30-1050Q88	21 ms
1200 mm	1270 mm	SLSP14-1200Q88	40 ms	SLSP30-1200Q88	23 ms
1350 mm	1420 mm	SLSP14-1350Q88	43 ms	SLSP30-1350Q88	25 ms
1500 mm	1569 mm	SLSP14-1500Q88	48 ms	SLSP30-1500Q88	27 ms
1650 mm	1719 mm	SLSP14-1650Q88	52 ms	SLSP30-1650Q88	30 ms
1800 mm	1869 mm	SLSP14-1800Q88	56 ms	SLSP30-1800Q88	32 ms
1950 mm	2018 mm	/	/	SLSP30-1950Q88	34 ms
2100 mm	2168 mm	/	/	SLSP30-2100Q88	36 ms
2250 mm	2318 mm	/	/	SLSP30-2250Q88	38 ms
2400 mm	2468 mm	/	/	SLSP30-2400Q88	40 ms

Models with 300 mm M12 pigtail QD also available. Emitter models with TEST function also available.

EZ-SCREEN Standard Cascadable

Dimensions		14 mm Resolution – Range 0.1 – 6 m 8-pin M12 QD		30 mm Resolution – Range 0.1 – 18 m 8-pin M12 QD	
Defined Area	Housing Length	Model Pair (E+R)	Response Time	Model Pair (E+R)	Response Time
300 mm	372 mm	SLSCP14-300Q88	15 ms	SLSCP30-300Q88	11 ms
450 mm	522 mm	SLSCP14-450Q88	19 ms	SLSCP30-450Q88	13 ms
600 mm	671 mm	SLSCP14-600Q88	23 ms	SLSCP30-600Q88	15 ms
750 mm	821 mm	SLSCP14-750Q88	27 ms	SLSCP30-750Q88	17 ms
900 mm	971 mm	SLSCP14-900Q88	32 ms	SLSCP30-900Q88	19 ms
1050 mm	1120 mm	SLSCP14-1050Q88	36 ms	SLSCP30-1050Q88	21 ms
1200 mm	1270 mm	SLSCP14-1200Q88	40 ms	SLSCP30-1200Q88	23 ms
1350 mm	1420 mm	SLSCP14-1350Q88	43 ms	SLSCP30-1350Q88	25 ms
1500 mm	1569 mm	SLSCP14-1500Q88	48 ms	SLSCP30-1500Q88	27 ms
1650 mm	1719 mm	SLSCP14-1650Q88	52 ms	SLSCP30-1650Q88	30 ms
1800 mm	1869 mm	SLSCP14-1800Q88	56 ms	SLSCP30-1800Q88	32 ms
1950 mm	2018 mm	/	/	SLSCP30-1950Q88	34 ms
2100 mm	2168 mm	/	/	SLSCP30-2100Q88	36 ms
2250 mm	2318 mm	/	/	SLSCP30-2250Q88	38 ms
2400 mm	2468 mm	/	/	SLSCP30-2400Q88	40 ms



Cordsets



Length	8-pin M12 QD (A)
5 m	QDE-815D
8 m	QDE-825D
15 m	QDE-850D
23 m	QDE-875D
30 m	QDE-8100D



Length	8-pin M12 QD Double-Ended (C)
0.3 m	DEE2R-81D
0.9 m	DEE2R-83D
2.4 m	DEE2R-88D
4.6 m	DEE2R-815D
8 m	DEE2R-825D
15 m	DEE2R-850D
23 m	DEE2R-875D
30 m	DEE2R-8100D

Splitter Cordsets

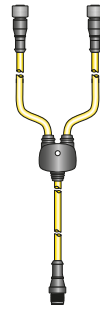

Trunk Length	8-pin M12 QD Splitter (B)
No branches, no trunk	CSB-M1280M1280
0.3 m	CSB-M1281M1281
2.5 m	CSB-M1288M1281
4.6 m	CSB-M12815M1281
7.6 m	CSB-M12825M1281
7.6 m	Flying leads
	CSB-UNT825M1281



Other hookup schemes are possible: cordset A can be used individually for the E/R hookup, without splitter cables.

Interface Modules



Model (24 VDC)	Output	Output Rating
IM-T-9A	3 NO	6 A
IM-T-11A	2 NO/1 NC	6 A

Brackets

EZA-MBK-11*

EZA-MBK-12*

EZA-MBK-20

EZA-MBK-21**

*Standard brackets included with emitter/receiver

**Cascadable models only



Flanges in

Flanges out

Flanges in

Flanges out



EZ-SCREEN LP (Low Profile)

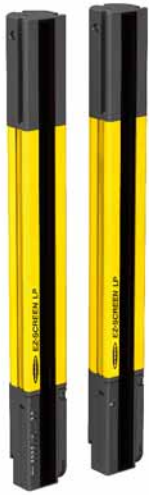

Type 4, Cat 4 PLe, SIL 3, SIL CL 3
2 PNP Safety Outputs (OSSD) and 1 auxiliary output, 24 VDC power supply

Dimensions		14 mm Resolution – Range 0.1 – 7 m Integral Removable Disconnect (RD)		25 mm Resolution – Range 0.1 – 7 m Integral Removable Disconnect (RD)	
Defined Area	Housing Length	Model Pair (E+R)	Response Time	Model Pair (E+R)	Response Time
270 mm	270 mm	SLPP14-270	10.5 ms	SLPP25-270	8 ms
410 mm	410 mm	SLPP14-410	13.5 ms	SLPP25-410	9.5 ms
550 mm	549 mm	SLPP14-550	16.5 ms	SLPP25-550	11 ms
690 mm	689 mm	SLPP14-690	19.5 ms	SLPP25-690	12.5 ms
830 mm	829 mm	SLPP14-830	22.5 ms	SLPP25-830	14 ms
970 mm	969 mm	SLPP14-970	25.5 ms	SLPP25-970	15.5 ms
1110 mm	1108 mm	SLPP14-1110	28.5 ms	SLPP25-1110	17 ms
1250 mm	1248 mm	SLPP14-1250	31.5 ms	SLPP25-1250	18.5 ms
1390 mm	1388 mm	SLPP14-1390	34.5 ms	SLPP25-1390	20 ms
1530 mm	1528 mm	SLPP14-1530	37.5 ms	SLPP25-1530	21 ms
1670 mm	1667 mm	SLPP14-1670	40.5 ms	SLPP25-1670	22.5 ms
1810 mm	1807 mm	SLPP14-1810	43.5 ms	SLPP25-1810	24 ms

Models with 8-pin M12 pigtail QD also available (add **P88** to the above model pair).
Pigtail models come with DELPE-81D cordset pre-installed.
For 8-pin M12 QD cordsets, splitter cordsets and double-ended cordsets, see page 15.

EZ-SCREEN LP (Low Profile) Cascadable



Type 4, Cat 4 PLe, SIL 3, SIL CL 3
2 PNP Safety Outputs (OSSD) and 1 auxiliary output, 24 VDC power supply

Dimensions		14 mm Resolution – Range 0.1 – 7 m Integral Removable Disconnect (RD)		25 mm Resolution – Range 0.1 – 7 m Integral Removable Disconnect (RD)	
Defined Area	Housing Length	Model Pair (E+R)	Response Time	Model Pair (E+R)	Response Time
410 mm	410 mm	SLPCP14-410	13.5 ms	SLPCP25-410	9.5 ms
550 mm	549 mm	SLPCP14-550	16.5 ms	SLPCP25-550	11 ms
690 mm	689 mm	SLPCP14-690	19.5 ms	SLPCP25-690	12.5 ms
830 mm	829 mm	SLPCP14-830	22.5 ms	SLPCP25-830	14 ms
970 mm	969 mm	SLPCP14-970	25.5 ms	SLPCP25-970	15.5 ms
1110 mm	1108 mm	SLPCP14-1110	28.5 ms	SLPCP25-1110	17 ms
1250 mm	1248 mm	SLPCP14-1250	31.5 ms	SLPCP25-1250	18.5 ms
1390 mm	1388 mm	SLPCP14-1390	34.5 ms	SLPCP25-1390	20 ms
1530 mm	1528 mm	SLPCP14-1530	37.5 ms	SLPCP25-1530	21 ms
1670 mm	1667 mm	SLPCP14-1670	40.5 ms	SLPCP25-1670	22.5 ms
1810 mm	1807 mm	SLPCP14-1810	43.5 ms	SLPCP25-1810	24 ms

Models with 8-pin M12 pigtail QD also available (add **P88** to the above model pair).
Pigtail models come with DELPE-81D cordset pre-installed.
For 8-pin M12 QD cordsets, splitter cordsets and double-ended cordsets, see page 15.

Cordsets

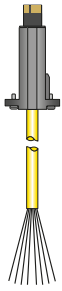

Length	8-wire RD (Removable disconnect)
4.6 m	RDLP-815D
8 m	RDLP-825D
15 m	RDLP-850D
23 m	RDLP-875D
30 m	RDLP-8100D



Length	8-pin RD (male) to M12 QD
0.3 m	DELPE-81D
0.9 m	DELPE-83D
2.4 m	DELPE-88D
4.6 m	DELPE-815D
8 m	DELPE-825D
15 m	DELPE-850D
23 m	DELPE-875D
30 m	DELPE-8100D

For 8-pin M12 QD cordsets, splitter cordsets and double-ended cordsets, see page 15.

Cordsets for Cascadables

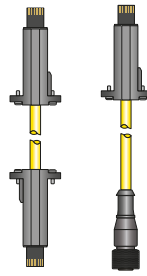

Length	RD to RD	RD to M12 Female* QD
5 cm	DELP-110E	/
0.3 m	DELP-111E	DELPEF-81D
0.9 m	DELP-113E	DELPEF-83D
2.4 m	DELP-118E	DELPEF-88D
4.6 m	DELP-1115E	DELPEF-815D
8 m	DELP-1125E	/
15 m	DELP-1150E	/
23 m	DELP-1175E	/
30 m	DELP-11100E	/

*Can be used with DEE2R-8..D

Interface Modules



Model (24 VDC)	Output	Output Rating
IM-T-9A	3 NO	6 A
IM-T-11A	2 NO/1 NC	6 A

Brackets

LPA-MBK-11*

LPA-MBK-12*

LPA-MBK-20

*Standard brackets included with emitter/receiver



Flanges in

Flanges out



Brackets for Cascadables

LPA-MBK-21

LPA-MBK-90

LPA-MBK-120



LPA-MBK-135

LPA-MBK-180



EZ-SCREEN LPM (Low Profile with Muting)



Type 4, Cat 4 Ple, SIL 3, SIL CL 3 – Integral muting
 2 PNP Safety Outputs (OSSD), 2 muting inputs, additional inputs for configuration of the muting function,
 1 auxiliary output, 24 VDC power supply

Dimensions		14 mm Resolution – Range 0.1 – 7 m 12-pin M12 pigtail QD		25 mm Resolution – Range 0.1 – 7 m 12-pin M12 pigtail QD	
Defined Area	Housing Length	Model Pair (E+R)	Response Time	Model Pair (E+R)	Response Time
410 mm	410 mm	SLPMP14-410P128	13.5 ms	SLPMP25-410P128	9.5 ms
550 mm	549 mm	SLPMP14-550P128	16.5 ms	SLPMP25-550P128	11 ms
690 mm	689 mm	SLPMP14-690P128	19.5 ms	SLPMP25-690P128	12.5 ms
830 mm	829 mm	SLPMP14-830P128	22.5 ms	SLPMP25-830P128	14 ms
970 mm	969 mm	SLPMP14-970P128	25.5 ms	SLPMP25-970P128	15.5 ms
1110 mm	1108 mm	SLPMP14-1110P128	28.5 ms	SLPMP25-1110P128	17 ms
1250 mm	1248 mm	SLPMP14-1250P128	31.5 ms	SLPMP25-1250P128	18.5 ms
1390 mm	1388 mm	SLPMP14-1390P128	34.5 ms	SLPMP25-1390P128	20 ms
1530 mm	1528 mm	SLPMP14-1530P128	37.5 ms	SLPMP25-1530P128	21 ms
1670 mm	1667 mm	SLPMP14-1670P128	40.5 ms	SLPMP25-1670P128	22.5 ms
1810 mm	1807 mm	SLPMP14-1810P128	43.5 ms	SLPMP25-1810P128	24 ms

Models with integral Removable Disconnect (RD) also available

Cordsets

3-Branch Muting Splitter Cordsets (D)	Sensor (PNP)
CSM3DO-M12121FM12121M	DO (pin 2)
CSM3LO-M12121FM12121M	LO (pin 4)

4-Branch (E) (EZ-SCREEN LP Emitter Hookup)	Sensor (PNP)
CSM4DO-M12121FM12121M	DO (pin 2)
CSM4LO-M12121FM12121M	LO (pin 4)

Muting Sensor Cordsets (F)	Length
DEE2R-51D	0.3 m
DEE2R-53D	0.9 m
DEE2R-58D	2.5 m
DEE2R-815D	4.6 m

Other hookup schemes are possible

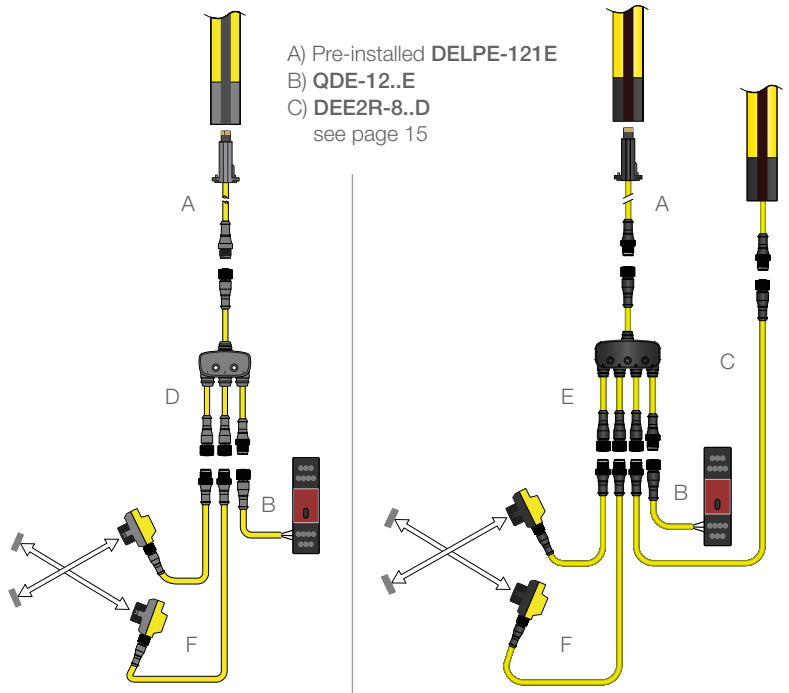

EZ-LIGHT Muting Indicators, cordsets and brackets

Model	Colours	Model	Description
TL50WQ	1: White	DELPEF-40D	Single colour cordset, 5 cm
TL50GYRWQ	4: Green/Yellow/Red/White	DELPEF-50D	Multicolour cordset, 5 cm
K50LGRW2PQ-18886	3: Green/Red/White	LPA-MBK-15	bracket used with DELPEF-.0D

EZ-SCREEN Type 2

Type 2, Cat 2 PLC – Hand and ankle detection suited to lower risk applications
2 PNP Safety Outputs (OSSD), 24 VDC power supply

30 mm Resolution – Range 15 m, 8-pin M12 QD, E+R pair listed



Defined Area	Housing Length	Response Time	Automatic Restart – Trip	Manual Restart – Latch
150 mm	215 mm	11 ms	LS2TP30-150Q88	LS2LP30-150Q88
300 mm	365 mm	13 ms	LS2TP30-300Q88	LS2LP30-300Q88
450 mm	515 mm	14 ms	LS2TP30-450Q88	LS2LP30-450Q88
600 mm	665 mm	16 ms	LS2TP30-600Q88	LS2LP30-600Q88
750 mm	815 mm	17 ms	LS2TP30-750Q88	LS2LP30-750Q88
900 mm	964 mm	19 ms	LS2TP30-900Q88	LS2LP30-900Q88
1050 mm	1114 mm	21 ms	LS2TP30-1050Q88	LS2LP30-1050Q88
1200 mm	1264 mm	22 ms	LS2TP30-1200Q88	LS2LP30-1200Q88
1350 mm	1414 mm	24 ms	LS2TP30-1350Q88	LS2LP30-1350Q88
1500 mm	1563 mm	25 ms	LS2TP30-1500Q88	LS2LP30-1500Q88
1650 mm	1713 mm	27 ms	LS2TP30-1650Q88	LS2LP30-1650Q88
1800 mm	1863 mm	29 ms	LS2TP30-1800Q88	LS2LP30-1800Q88

Cordsets

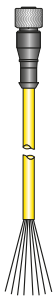

Length	8-pin M12 QD
5 m	QDE-815D
8 m	QDE-825D
15 m	QDE-850D
23 m	QDE-875D
30 m	QDE-8100D

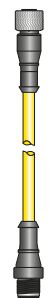

Length	8-pin M12 QD Double-Ended
0.3 m	DEE2R-81D
0.9 m	DEE2R-83D
2.4 m	DEE2R-88D
4.6 m	DEE2R-815D
8 m	DEE2R-825D
15 m	DEE2R-850D
23 m	DEE2R-875D
30 m	DEE2R-8100D

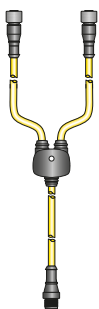

Trunk Length	8-pin M12 QD Splitter
No branches, no trunk	CSB-M1280M1280
0.3 m	CSB-M1281M1281
2.5 m	CSB-M1288M1281
4.6 m	CSB-M12815M1281
7.6 m	CSB-M12825M1281
7.6 m Flying leads	CSB-UNT825M1281

Brackets

USMB-1*

*Standard bracket included with emitter/receiver



Flanges in

Flanges out



USCMB-



USMB-6



Flanges in

Flanges out



USMB-8

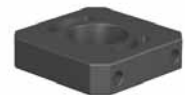

AG4 Safety Laser Scanner



Type 3, Cat 3 PLd, SIL 2, SIL CL 2 – Stationary and mobile applications
2 PNP Safety Outputs (OSSD), 2 PNP auxiliary outputs, 24 VDC power supply

Warning field: 15 m (150 mm resolution) – Response time: 80 ms (default) adjustable to 640 ms
Scanning angle 190°

Model	Resolution	Protective Fields	Maximum Protective Range
AG4-4E	30 mm	1.6 m	4 m (maximum warning range 15 m)
AG4-4E	40 mm	2.2 m	
AG4-4E	50 mm	2.8 m	
AG4-4E	70 mm	4.0 m	
AG4-4E	150 mm	4.0 m	
AG4-6E	30 mm	1.6 m	6.25 m (maximum warning range 15 m)
AG4-6E	40 mm	2.2 m	
AG4-6E	50 mm	2.8 m	
AG4-6E	70 mm	6.25 m	
AG4-6E	150 mm	6.25 m	

Includes scanner, plugs and CD with diagnostic and configuration software, cordset ordered separately

Cordsets

Brackets



Length	DB15 Machine Interface
5.00 m	AG4-CPD15-5
10.0 m	AG4-CPD15-10
25.0 m	AG4-CPD15-25
50.0 m	AG4-CPD15-50
Length	DB9 PC Communication
3.00 m	AG4-PCD9-3
5.00 m	AG4-PCD9-5
10.0 m	AG4-PCD9-10
RS-232 Serial Protocol	
Length	DB9 to USB
1.00 m	AG4-PCD9USB-1
Not recommended for use with AG4-PCD9-10	

AG4-MBK1 Adjustable mounting bracket



Interface Modules

Test & Clone Box

Universal safety input, 24 VDC



Model	Output	Output Rating
UM-FA-9A	3 NO	6 A
UM-FA-11A	2 NO/1 NC	7 A



AG4-TB1

STB Self-Checking Touch Buttons



Model	Connection	Touch Surface Material	Output	Power Supply
STBVP6	2 m cable	Polyetherimide (PEI)	Solid-state 2 Complementary PNP (1 ON, 1 OFF)	10-30 VDC
STBVP6Q5	4-pin M12 QD			
STBVR81	2 m cable	Polyetherimide (PEI)	E/M Relay 2 Complementary SPST (1 NC, 1 NO)	20-30 VAC/DC
STBVR81Q6	5-pin M12 QD			

STB buttons include yellow field cover to prevent unintended switching. To comply to safety standards, STB buttons must be used with DUO-TOUCH SG Two-Hand control modules, SC26-2.. or XS26-2.. Safety Controller or comparable Type IIIC Two-Hand system.

Cordsets for STBs

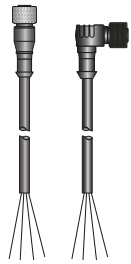

4-pin threaded M12 QD to flying leads		
Length	Straight	Right-Angle
2 m	MQDC-406	MQDC-406RA
4.6 m	MQDC-415	MQDC-415RA
9 m	MQDC-430	MQDC-430RA
15 m	MQDC-450	MQDC-450RA

5-pin threaded M12 QD to flying leads		
Length	Straight	Right-Angle
2 m	MQDC1-506	MQDC1-506RA
5 m	MQDC1-515	MQDC1-515RA
9 m	MQDC1-530	MQDC1-530RA

Brackets

SMBAMS30P	SMBAMS30RA	SMB30SC

DUO-TOUCH Run Bar with STBVP6

Ergonomic design for reduced wrist, hand and arm stress



Model	Connection	E-Stop
STBVP6-RB2	Terminal strip	Not included
STBVP6-RB2Q8	8-pin 7/8 QD	Not included
STBVP6-RB2E02	Terminal strip	SSA-EBM-02L

Telescopic stands for Run Bars

STBA-RB2-S1 (floor mounted)

STBA-RB2-S2 (free standing)

Run Bars are sold separately

Cordsets for Run Bar



Length	8-pin 7/8 QD to flying leads
4.5 m	QDS-815C
8 m	QDS-825C
15 m	QDS-850C
23 m	QDS-875C

Brackets for Run Bars

STBA-RB2-MB1	STBA-RB2-MB2	STBA-RB2-MB3

E-Stop Buttons

30 mm Mount Electro-Mechanical E-Stop Push Button, IP65 rating



Model	Connection	E-Stop Contacts	Illuminated Base
SSA-EB1P-02ECQ4	4-pin M12 QD	2 NC	/
SSA-EB1P-11ECQ4	4-pin M12 QD	1 NO/1 NC	/
SSA-EB1P-22ECQ8	8-pin M12 QD	2 NO/2 NC	/
SSA-EB1PLYR-12ECQ8	8-pin M12 QD	1 NO (PNP)/2 NC	Yellow & Red (Flashing/Solid)
SSA-EB1PLGR-12ECQ8	8-pin M12 QD	1 NO (PNP)/2 NC	Green & Red (Flashing/Solid)
SSA-EB1PLXR-12ECQ8	8-pin M12 QD	1 NO (PNP)/2 NC	OFF & Red (Flashing/Solid)
SSA-EB1PL-12ECQ8	8-pin M12 QD	1 NO (PNP)/2 NC	OFF & Red (Solid/Solid)

Flat Mount Electro-Mechanical E-Stop Push Button, IP65 rating



Standard Actuator	Lockable Actuator	E-Stop Contacts	Connection
SSA-EB1P-02ED1Q4	SSA-EB1MP-02ED1Q4	2 NC	4-pin M12 QD
SSA-EB1P-11ED1Q4	SSA-EB1MP-11ED1Q4	1 NO/1 NC	4-pin M12 QD
SSA-EB1P-22ED1Q8	SSA-EB1MP-22ED1Q8	2 NO/2 NC	8-pin M12 QD
SSA-EB1PL2-12ED1Q8	SSA-EB1ML2P-12ED1Q8	1 NO/2 NC Illuminated button (Push ON)	8-pin M12 QD

Illuminated-base, with 1 NO (PNP)/2 NC E-Stop Contacts, IP65 rating, 8-pin M12 QD



Standard Actuator	Lockable Actuator	Illuminated Base
SSA-EB1PLXR-12ED1Q8	SSA-EB1MLXRP-12ED1Q8	OFF & Red (Flashing/Solid)
SSA-EB1PLYR-12ED1Q8	SSA-EB1MLYRP-12ED1Q8	Yellow & Red (Flashing/Solid)
SSA-EB1PL-12ED1Q8	SSA-EB1MLP-12ED1Q8	OFF & Red (Solid/Solid)
SSA-EB1PLGR-12ED1Q8	SSA-EB1MLGRP-12ED1Q8	Green & Red (Flashing/Solid)

AB/Rockwell® and Siemens® Safety BUS node compatible models also available

Cordsets

A) Double-ended M12

Pin	(Trunk) Length	Model
5*	0.3 m	DEE2R-51D
8	0.3 m	DEE2R-81D
5*	2.5 m	DEE2R-58D
8	2.5 m	DEE2R-88D

B) Splitter 2x female M12 + 1x male M12

4	0.3 m	CSS-M12F41M12M41M12F41
8	0.3 m	CSS-M12F81M12M81M12F81
4	2.5 m	CSS-M12F48M12M41M12F41
8	2.5 m	CSS-M12F88M12M81M12F81

C) M12 to single ended flying leads

4	2 m	MQDC-406
4	4.6 m	MQDC-415
8	2 m	MQDC2S-806
8	4.6 m	MQDC2S-815

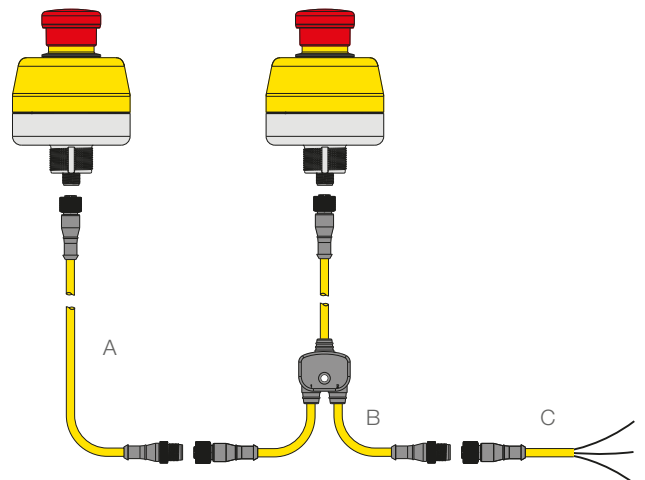

*Use also with 4-pin E-Stop buttons.
Other hookup schemes are possible. More lengths available.

2-Hand-Control Modules



DUO-TOUCH SG Two-Hand Control Modules
2 NO Safety Outputs, 24 VAC/DC power supply, IP20 rating, meets Cat 4 and Type IIIC

Model	Inputs	Output Rating	Terminals
AT-FM-10K	2 STB* (see page 17)	6 A	Removable

*May also use 2 mechanical push buttons, each with 1 NO and 1 NC contact

DUO-TOUCH SG Kits with STB Touch Buttons
2 NO Safety Outputs, no auxiliary outputs, 24 VAC/DC power supply, meets Cat 4 and Type IIIC



Kit	Module	IP Rating	STB Buttons (2 pieces)	IP Rating	Connection
ATK-VP6	AT-FM-10K	IP20	STBVP6	IP66	2 m cable
ATK-VP6Q5	AT-FM-10K	IP20	STBVP6Q5	IP66	4-pin M12 QD

Kit does not include run bar

ED1G Enabling Devices

3-position switches for enabling and hold-to-run applications, IP65 rating



Model	Contact Configuration	Momentary Push Button	ED9Z-GH1 Bracket
ED1G-L21SM-1N	2 NO & 1 NC Aux	/	
ED1G-L21SMB-1N	2 NO & 1 NC Aux	1 NO	
ED1G-L20MB-1N	2 NO	2 NO	



Also available:



E-Stop Modules, Muting Modules and Safe Speed Modules

- E-Stop and interlocked guard modules monitor contact failure or wiring fault
- Muting modules suspend safeguarding during hazard-free times in the machine's cycle and allow material to move into or from the process, without tripping the primary safeguard
- Safe speed monitoring modules monitor two sensors with PNP outputs for rotation and linear movements. They allow safety switches to release and safety gates to be opened when the speed drops below the dangerous level.

Interlocking Switches

- Magnet style switches for non-contact applications are compact, 3-piece non-contact systems that are designed to resist intentional defeat
- One-piece load-bearing, lever and rotating hinge style switches with an adjustable range of operation
- Compact plastic switches are designed to minimize tampering and exist in five actuator types, to actuator engagement from different locations
- Compact metal switches are rigid and flexible in-line actuators with rotating actuator heads
- Locking style switches with two options for locking mechanisms. Exist in two models for different voltages, and are rigid and flexible in-line actuators with rotating actuator heads.



Sensors



Vision



Lighting & Indication



Wireless I/O



Machine Safety



Global Presence – Regional Offices

We are a global company with a focus on our commitment to customers around the world. Banner has worldwide support with a network of 3.000 professionals who are ready to help you in your plant no matter where you are located.

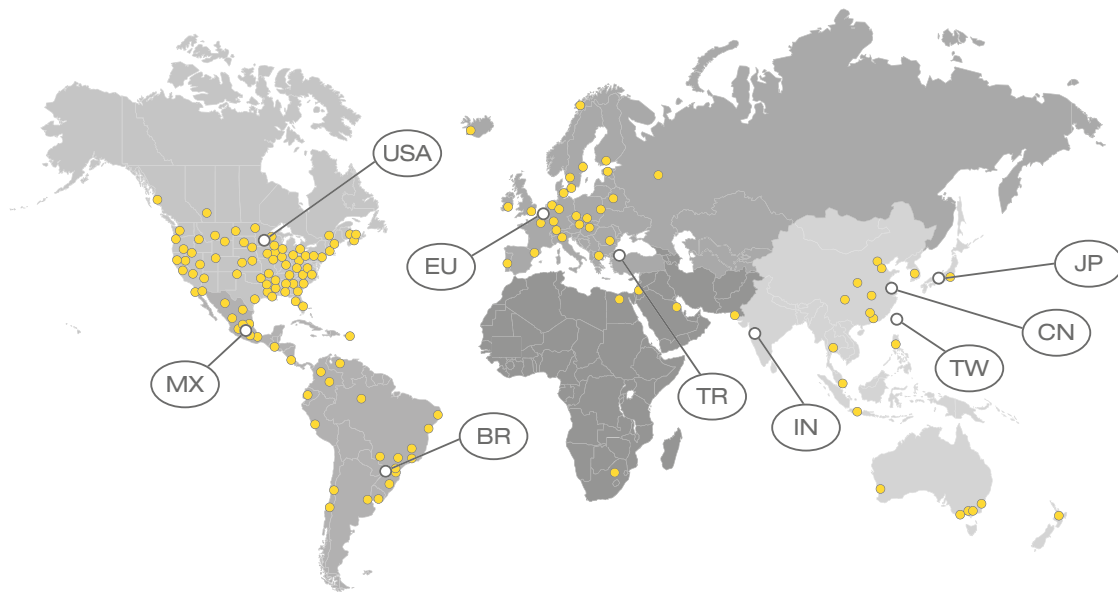

Banner Engineering EMEA | Diegem, Belgium | Phone +32 2 456 07 80 | mail@bannerengineering.com | www.bannerengineering.com | www.bannerengineering.com/eu – **Banner Engineering (HQ)** | Minneapolis, MN, USA | Phone: +1 763 544 3164 | www.bannerengineering.com – **Banner Engineering Turkey** | Batı Ataşehir, Istanbul | Phone: +90 216 688 8282 | turkey@bannerengineering.com.tr | www.bannerengineering.com.tr – **Banner Engineering India** | Pune | Phone: +91 20 664 056 24 | salesindia@bannerengineering.com | www.bannerengineering.co.in – **Banner Engineering do Brasil** | Jundiaí – SP | Phone: +55 11 2709 9880 | brasil@bannerengineering.com | www.bannerengineering.com.br – **Banner Engineering de Mexico** | Monterrey | Phone: +52 81 8363 2714 | mexico@bannerengineering.com | www.bannerengineering.com.mx – **Banner Engineering China** | Shanghai | Phone: +86 21 24 22 68 88 | sensors@bannerengineering.com.cn | www.bannerengineering.com.cn – **Banner Engineering Japan** | Osaka | Phone: +81 6 6309 0411 | mail@bannerengineering.co.jp | www.bannerengineering.co.jp – **Banner Engineering Taiwan** | Taipei | Phone: +886 2 8751 9966 | info@bannerengineering.com.tw | www.bannerengineering.com.tw

EN F142 Rev C – 04/16

www.bannerengineering.com/eu

