

BANNER[®]
more sensors, more solutions



Wireless Products





more sensors, more solutions

Wireless Products



Who is Banner?

Every 3.5 seconds, a Banner sensor is installed somewhere in the world. Banner solves problems for most of the manufacturing companies in the Fortune 500, who rely on Banner for reliable automation solutions.

Banner products help manufacture the cars you drive, the TVs you watch, the food you eat, the medicine you take and virtually every product you consume. Whatever the industry, Banner has a solution to help you automate your plants, improve efficiency and manufacture quality products.

Manufacturing Specialists

Banner is a leading source for manufacturing needs with an extensive product line. With over 30,000 products, including our award-winning sensors, wireless solutions, vision sensors and lighting, machine safety, indicator lights and LED lighting, we have a solution for you.

Application Solution Experts

Our field sales engineers are the most highly-trained and experienced professionals in the industry. They can rapidly analyze an application to help you find the best solution.

Global Presence

We are a global company with a focus on our commitment to customers around the world. Banner has worldwide support with a network of 3,000 professionals who are ready to help you in your plant no matter where you are located.

Banner Specials

Banner's growing family of products include thousands of standard products. However, if you have an application requiring a unique solution, contact one of Banner's Application Engineers and learn about our rapid customization and ability to deliver special product variations.

Table of Contents

Sensors and Solutions	6
Vibration & Temperature	8
Temperature & Humidity	10
Q45	14
Wireless Tower Light	24
Vehicle Detection	26
Simple Wire Replacement	30
PM Series	32
Performance Board Modules	34
Serial Data Radios	36
Ethernet Data Radios	38
Wireless I/O, Data, and Network Connectivity	42
Performance Series Gateways	44
Performance Series Nodes	46
MultiHop Modbus Radios	50
Intrinsically Safe Nodes	54
DXM100 Controller	56
Accessories	60
Reference	76
How to Reach Us	79

Powerful Capabilities

Sophisticated Functionality

Engineered Simplicity



Reliable

Good signal strength assures uninterrupted communication. Banner offers an integrated site survey capability to evaluate and ensure good radio signal strength prior to installation.



Scalable

Banner wireless networks grow with your needs. Simple wire replacement products are preconfigured to support up to six Nodes and can be expanded to accommodate as many as 47 Nodes using the configuration software.





Long Range

Designed for long distance applications, Banner wireless networks are capable of up to six miles of line-of-sight coverage, making them an ideal solution for applications in remote and difficult to access locations or where running wire or conduit is impractical or too expensive.



Easy-to-Use

Banner's Simple Wire Replacement product line provides flexible networks that are easy to set up without software. Setting up a basic point-to-point network is as easy as pairing a cell phone to a headset.



Secure

Binding radio Nodes in a network locks them to a specific Gateway. After the devices are bound, each Gateway only accepts data from the Nodes that are bound to it.





Sensors & Solutions

Banner's wireless sensors, combined with Banner's I/O Radios, allow you to automate monitoring and data collection from around your facility. Temperature and humidity sensors can help minimize material loss in climate controlled areas. Vibration and temperature sensors can detect failing motors before they shut down, minimizing downtime and machine damage. Wireless Tower Lights provide indication around your facility. All Banner wireless sensors are optimized to work with Banner's wireless I/O Radios.

Vibration and Temperature Sensor

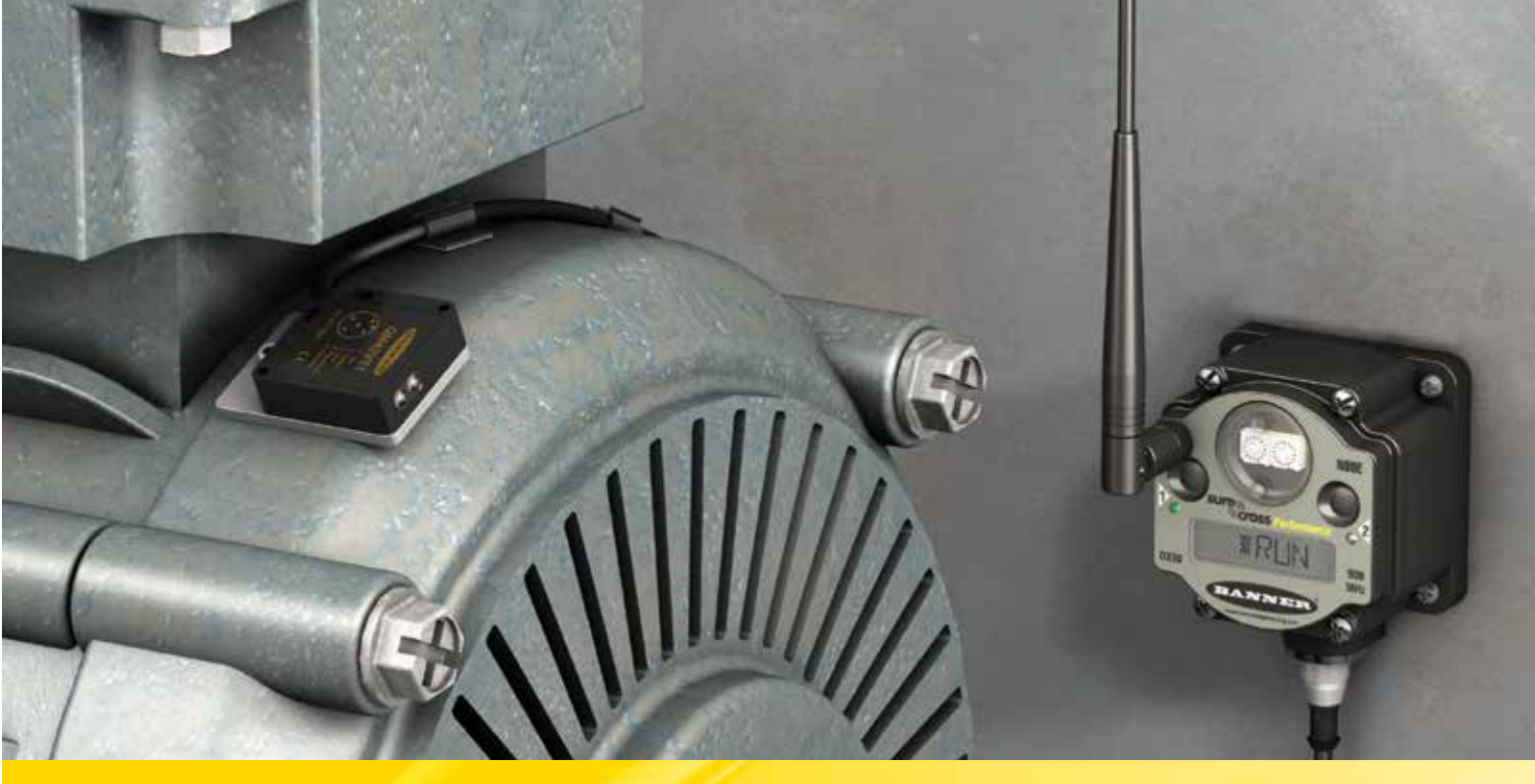

QM42VT1



The QM42VT1 Vibration and Temperature Sensor makes it easy to monitor a machine's health. It measures RMS velocity and temperature so that problems can be detected before they become too severe and cause additional damage or result in unplanned downtime. Paired with a Banner wireless Node, it can provide local indication, wirelessly send the signal to a central location, and send the vibration and temperature data to the Gateway for collection and trending.

Key Features:

- Easily monitor machine health by sending info wirelessly to wherever you need it
- Avoid machine failures and delays by detecting problems early
- Reduce downtime and plan maintenance more efficiently
- Monitor a variety of machines to suit your needs
 - Motors
 - Fans
 - Pumps
 - Blowers
 - Compressors
 - Gear Boxes

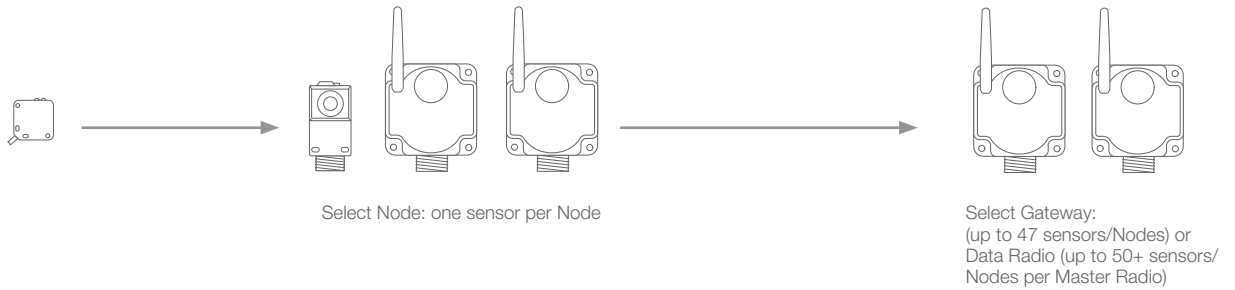

Sensor with Serial Interface

Model	Description
QM42VT1	Vibration and temperature via a 1-wire serial interface

Nodes with Serial Interface

Models	Description	
DX80N9Q45VT	Q45 Vibration/Temperature Node with integrated batteries	see page 14
DX80N2Q45VT		
DX80N9X1S-P6	1-wire serial Performance Node with integrated battery	see page 48
DX80N2X1S-P6		
DX80N9X6S-P6	1-wire serial Performance Node	see page 48
DX80N2X6S-P6		
DX80DR9M-H6	1-wire serial Modbus MultiHop Slave with integrated battery	see page 52
DX80DR2M-H6		

QM42VT1 Vibration and Temperature Sensor Specifications

Supply Voltage	3.6 to 5.5 V dc
Current	Active comms: 11.9 mA at 5.5 V dc
Communication Hardware	Interface: 1-wire serial interface Baud rates: 9.6k, 19.2k (default), or 38.4k Data format: 8 data bits, no parity (default), 1 stop bit (even or odd parity available)
Communication Protocol	Sure Cross® DX80 Sensor Node 1-wire serial Interface
Communications Line	Level Receive ON: Greater than 2 V Level Receive OFF: Less than 0.7 V Level Transmit ON: 2.7 to 3 V Level Transmit OFF: 0 V (pulldown resistor of 10 kOhm)
Vibration Sensor	Mounted base resonance: 5.5 kHz nominal Measuring Range: 0–65 mm/sec or 0–6.5 in/sec RMS Frequency Range: 10–1000 Hz Accuracy: ±10% and 25 °C
Connector	3 m cable with 5-pin M12 fitting
Indicators	Green flashing: Power ON Amber flicker: Serial Tx
Temperature Sensor	Measuring Range: –40 °C to +105 °C (–40 °F to +221 °F) Resolution: 0.1 °C Accuracy: ± 3 °C
Environmental Rating	NEMA 6P, IEC IP67
Operating Conditions	–40 to 85 °C (–40 to 185 °F)
Shock and Vibration	400G
Mounting Options	The VT1 sensor can be mounted using a variety of methods, including 1/4 inch 28 hex screw, epoxy, thermal tape, or magnetic mount

Temperature and Humidity Sensor



M12FTH4Q and M12FT4Q



A simple way to verify conditions in locations that were once too difficult to access via traditional monitoring methods. With no software required, you can replace cables and extend the range of temperature and humidity signals with minimal effort.

Key Features:

- Achieves temperature accuracy of ± 0.3 °C and humidity accuracy of $\pm 2\%$ relative humidity
- Temperature and relative humidity sensing elements housed in a robust metal housing
- Traceable to NIST standards
- Temperature and Humidity or Temperature-only Sensor to choose from
- Each sensor comes with a Certificate of Factory Calibration
- Reduces labor costs by obviating manual checks and reducing error

Simple Wire Replacement

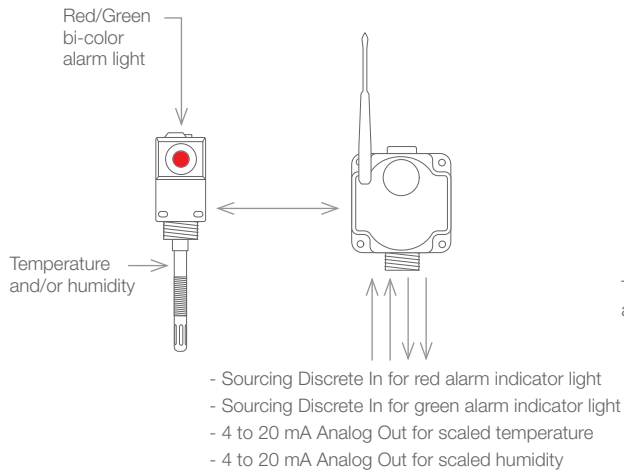

Host Controlled via Modbus RTU (up to 47 Nodes)

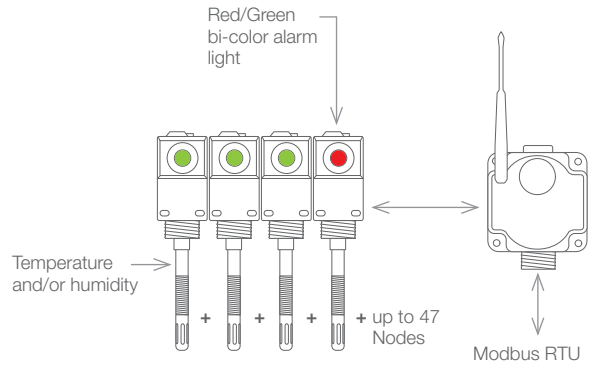

Sensors with Serial Interface

Models	Description
M12FTH4Q	Temperature and relative humidity via a 1-wire serial interface
M12FT4Q	Temperature via a 1-wire serial interface

Nodes with Serial Interface

DX80N2Q45TH	Q45 Temperature/Humidity Node with integrated batteries	see page 16
DX80N91X1S-P6	1-wire serial Performance Node with integrated battery	see page 48
DX80N21X1S-P6		
DX80N9X6S-P6	1-wire serial Performance Node	see page 48
DX80N2X6S-P6		
DX80DR9M-H6	1-wire serial Modbus MultiHop Slave with integrated battery	see page 52
DX80DR2M-H6		

M12FTH4Q and M12FT4 Specifications

Supply Voltage	3.6 to 5.5 V dc	
Current	Default sensing: 28 μ Amps Disabled sensing: 15 μ Amps Active comms: 4.7 mA	
Mounting Threads	M12 x 1	
Indicators	Green flashing: Power ON	Red flicker: Serial Tx
Communication Hardware	Interface: 1-wire serial interface Baud rates: 9.6k, 19.2k (default), or 38.4k	Data format: 8 data bits, no parity (default), 1 stop bit (even or odd parity available)
Communication Protocol	Sure Cross [®] DX80 Sensor Node 1-wire serial Interface	
Communications Line	Level Receive ON: Greater than 2 V Level Receive OFF: Less than 0.7 V	Level Transmit ON: 2.7 to 3 V Level Transmit OFF: 0 V (pulldown resistor of 10 kOhm)
Humidity	Measuring Range: 0 to 100% relative humidity Resolution: 0.1% relative humidity Accuracy: \pm 2% relative humidity at 25 $^{\circ}$ C NOTE: Humidity measurements are only available with the M12FTH4Q model. The M12FT4Q model does not include the humidity sensor.	
Temperature	Measuring Range: -40 to $+85$ $^{\circ}$ C (-40 to $+185$ $^{\circ}$ F) ² Resolution: 0.1 $^{\circ}$ C Accuracy: \pm 0.3 $^{\circ}$ C at 25 $^{\circ}$ C	
Environmental Rating	NEMA 6, IEC IP67	
Operating Conditions	-40 to 85 $^{\circ}$ C (-40 to 185 $^{\circ}$ F)	
Shock and Vibration	IEC 68-2-6 and IEC 68-2-27 Shock: 30g, 11 millisecond half sine wave, 18 shocks Vibration: 0.5 mm p-p, 10 to 60 Hz	

Temperature and Humidity Sensor



M12FTH3Q and M12FT3Q

This temperature and humidity solution works in a variety of environments to wirelessly provide temperature and humidity measurements via Modbus RTU, RS-485.

Key Features:

- Achieves humidity accuracy of $\pm 2\%$ relative humidity and temperature accuracy of ± 0.3 °C
- Manufactured with a robust metal housing
- Traceable to NIST standards
- Functions as a Modbus slave device via RS-485

Sensors with Modbus RTU

Models	Description
M12FTH3Q	Temperature and humidity sensor with Modbus RTU, RS-485 interface
M12FT3Q	Temperature sensor with Modbus RTU, RS-485 interface

Radios with Modbus RTU (see pages 50-51)

Models	I/O	Frequency	Environmental Rating
DX80DR9M-H1	Inputs: Four discrete, two 0 – 20 mA analog, one thermistor, one counter Outputs: Two NMOS discrete Switch Power Outputs: Two Serial interface: RS-485 Wireless Q45 Serial Node for use with either M12FTH3Q or M12FT3Q	900 MHz (1 W)	IP67
DX80DR2M-H1		2.4 GHz (65 mW)	IP67
DX80DR9M-H1E		900 MHz (1 W)	IP67
DX80DR2M-H1E		2.4 GHz (65 mW)	IP65
DX80DR9M-H2	Inputs: Four discrete, two 0-20 mA analog Outputs: Four sourcing discrete, two 0-20 mA analog Serial Interface: RS-485	900 MHz (1 W)	IP67
DX80DR2M-H2		2.4 GHz (65 mW)	IP67
DX80DR9M-HB1	Inputs: Two NPN discrete, two 0-20 mA analog Outputs: Two NMOS discrete Switch Power Outputs: Two	900 MHz (1 W)	Board module
DX80DR2M-HB1		2.4 GHz (65 mW)	Board module
DX80DR9M-HB2	Inputs: Two PNP discrete, two 0-20 mA analog Outputs: Two PNP discrete, two 0-20 mA analog	900 MHz (1 W)	Board module
DX80DR2M-HB2		2.4 GHz (65 mW)	Board module
DX80SR9M-H	Serial Interface: RS-232, RS-485	900 MHz (1 W)	IP67
DX80SR2M-H		2.4 GHz (65 mW)	IP67

M12FTH3Q and M12FT3Q Sensors Specifications

Supply Voltage	12 to 24 V dc or 3.6 to 5.5 V dc low power option
Current	Default sensing: 45 μ Amps Disabled sensing: 32 μ Amps Active comms: 4 mA
Mounting Threads	M12 x 1
Indicators	Green flashing: Power ON Red flicker: Serial Tx
Communication Hardware	Interface: RS-485 serial Baud rates: 9.6k, 19.2k (default), or 38.4k Data format: 8 data bits, no parity (default), 1 stop bit (even or odd parity available)
Communication Protocol	Modbus RTU
Humidity	Measuring Range: 0 to 100% relative humidity Resolution: 0.1% relative humidity Accuracy: \pm 2% relative humidity at 25 °C NOTE: Humidity measurements are only available with the M12FTH3Q model. The M12FT3Q model does not include the humidity sensor.
Temperature	Measuring Range: -40 to +85 °C (-40 to +185 °F) ² Resolution: 0.1 °C Accuracy: \pm 0.3 °C at 25 °C
Environmental Rating	NEMA 6, IEC IP67
Operating Conditions	-40 to 85 °C (-40 to 185 °F)
Shock and Vibration	IEC 68-2-6 and IEC 68-2-27 Shock: 30g, 11 millisecond half sine wave, 18 shocks Vibration: 0.5 mm p-p, 10 to 60 Hz

Q45 Vibration and Temperature



Q45VT

The Q45VT provides a simple solution for predictive maintenance monitoring. Designed to pair with the QM42VT1, it easily connects with a 5-pin Euro connector. Vibration thresholds can be set using DIP switches and a built-in LED is pre-mapped to illuminate when a threshold has been exceeded.

Key Features:

- Easily connects using the 5-pin Euro connector
- Set vibration thresholds using DIP switches
- Built in LED is pre-mapped to illuminate when a threshold has been exceeded
- Integrated lithium batteries
- Available in 2.4 GHz and 900 MHz

Q45VT Node

Models	Description	Frequency
DX80N9Q45VT	Q45 Vibration/Temperature Node	900 MHz
DX80N2Q45VT		2.4 GHz

Vibration Sensor

QM42VT1	Vibration and temperature via a 1-wire serial interface	see page 8
---------	---	------------

Q45VT Specifications

	900 MHz	2.4 GHz
Radio Range	Up to 3.2 Km (2 miles) with line of sight	Up to 1000 m (3280 ft) with line of sight
Minimum Separation Distance	4.57 m (15 ft)	0.3 m (1 ft)
Transmit Power	1W (25 dBm)	65 mW
Compliance	FCC ID UE3RM1809 - This device complies with FCC Part 15, Subpart C, 15.247 ETSI EN 300 328 V1.8.1 IC: 7044A-RM1809	FCC ID UE300DX80-2400 - This device complies with FCC Part 15, Subpart C, 15.247 ETSI EN 300 328 V1.8.1 (2012-06) IC: 7044A-DX8024
Spread Spectrum Technology	FHSS (Frequency Hopping Spread Spectrum)	
Default Sensing Interval	5 minutes	
Indicators	Red and green LEDs (radio function)	
Connection	One 5-pin threaded M12/Euro-style female quick-disconnect	
Construction	Molded reinforced thermoplastic polyester housing, oring-sealed transparent Lexan® cover, molded acrylic lenses, and stainless steel hardware. Q45s are designed to withstand 1200 psi washdown.	
Battery Life at Default Sensing Interval	Up to 2.5 years	Up to 3 years
Environmental Rating	NEMA 6P, IEC IP67	
Operating Conditions	-40 °C to 70 °C (-40 °F to 158 °F); 90% relative humidity at 50 °C (non-condensing)	

Q45 Temperature and Humidity



Q45TH

The Q45TH connects directly to the M12FTH4Q & M12FT4Q sensors. With integrated lithium batteries, no software required to deploy it, and sample rates selectable using DIP switches, it is a simple solution for monitoring temp & humidity in climate controlled areas.

Key Features:

- Connects directly to the M12FTH4Q and the M12FT4Q
- Includes a red/green LED that can be used to provide local visual indication
- Set sample rates using DIP switches
- Integrated lithium batteries

Q45TH Node

Models	Description	Frequency
DX80N9Q45TH	Q45 Temperature and Humidity Node	900 MHz
DX80N2Q45TH		2.4 GHz

Temperature and Humidity Sensor

M12FTH4Q	Temperature and Humidity Sensor	see page 10
M12FT4Q	Temperature Sensor	

Q45TH Specifications

	900 MHz	2.4 GHz
Radio Range	Up to 3.2 Km (2 miles) with line of sight	Up to 1000 m (3280 ft) with line of sight
Minimum Separation Distance	4.57 m (15 ft)	0.3 m (1 ft)
Transmit Power	1W (25 dBm)	65 mW
Compliance	FCC ID UE3RM1809 - This device complies with FCC Part 15, Subpart C, 15.247 ETSI EN 300 328 V1.8.1 IC: 7044A-RM1809	FCC ID UE300DX80-2400 - This device complies with FCC Part 15, Subpart C, 15.247 ETSI EN 300 328 V1.8.1 (2012-04) IC: 7044A-DX8024
Spread Spectrum Technology	FHSS (Frequency Hopping Spread Spectrum)	
Default Sensing Interval	64 seconds	
Temperature Sensor	Measuring Range: -40 °C to +85 °C (-40 °F to +185 °F) Resolution: 0.1 °C Accuracy: ±0.3 °C	
Humidity Sensor	Measuring Range: 0% to 100% relative humidity Resolution: 0.1% relative humidity Accuracy: ±2% relative humidity at 23 °C	
Indicators	Red and green LEDs (radio function)	
Connection	One 5-pin threaded M12/Euro-style female quick-disconnect	
Construction	Molded reinforced thermoplastic polyester housing, oring-sealed transparent Lexan® cover, molded acrylic lenses, and stainless steel hardware. Q45s are designed to withstand 1200 psi washdown.	
Typical Battery Life at Default Sensing Interval	Up to 1.5 years	Up to 2 years
Environmental Rating	NEMA 6P, IEC IP67	
Operating Conditions	-40 °C to 70 °C (-40 °F to 158 °F); 90% relative humidity at 50 °C (non-condensing)	

Q45 Push Button



Q45BL

Sure Cross® Wireless Q45 Sensors combine the best of Banner's flexible Q45 sensor family with its reliable, field-proven, Sure Cross wireless architecture to solve new classes of applications limited only by the user's imagination.

Key Features:

- Wireless node with independently controlled push-button input and a two-color LED indicator light which can be configured for solid or flashing operation
- DIP switch configurable for either toggle or momentary operation
- IP67-rated housing for use in demanding environments
- 2.4 GHz ISM band radio meets worldwide standards

Applications:

- Call-for-parts
- Call-for-service
- Pick-to-light



Q45BL Push Button, Battery Power

Models	I/O	Frequency	Power	Environmental Rating
DX80N9Q45BL-RYGB	Inputs: One button Outputs: Two color light	900 MHz	Integrated battery	IP67, NEMA 6
DX80N2Q45BL-RG		2.4 GHz	Integrated battery	
DX80N2Q45BL-RG-L		2.4 GHz	10-30 V dc	

Q45BL Specifications

	900 MHz	2.4 GHz
Radio Range	Up to 3.2 Km (2 miles) with line of sight	Up to 1000 m (3280 ft) with line of sight
Minimum Separation Distance	4.57 m (15 ft)	0.3 m (1 ft)
Transmit Power	1W (25 dBm)	65 mW EIRP
Compliance	FCC ID UE3RM1809 - This device complies with FCC Part 15, Subpart C, 15.247 ETSI EN 300 328 V1.8.1 IC: 7044A-RM1809	FCC ID UE300DX80-2400 - This device complies with FCC Part 15, Subpart C, 15.247 ETSI/EN: In accordance with EN 300 328: V1.8.1 (2012-04) IC: 7044A-DX8024
Spread Spectrum Technology	FHSS (Frequency Hopping Spread Spectrum)	
Button Input	Sample Rate: 62.5 milliseconds Report Rate: On change of state ON Condition: Button pressed OFF Condition: Button not pressed	
Construction	Molded reinforced thermoplastic polyester housing, oring-sealed transparent Lexan® cover, molded acrylic lenses, and stainless steel hardware. Q45s are designed to withstand 1200 psi washdown.	
Supply Voltage	10 to 30 V dc (DX80N2Q45BL-RG-L)	
Current Consumption	Less than 10 mA (DX80N2Q45BL-RG-L)	
Default Sensing Interval	62.5 milliseconds	
Report Rate	On Change of State	
Adjustments	Multi-turn sensitivity control (allows precise sensitivity setting - turn clockwise to increase gain)	
Indicators	Red and green LEDs (radio function); amber LED indicates when input 1 is active	
Environmental Rating	NEMA 6, IEC IP67	
Operating Conditions	-40 °C to 70 °C (-40 °F to 158 °F); 90% relative humidity at 50 °C (non-condensing)	

Certifications



Q45 Remote Device



Q45RD

Sure Cross® Wireless Q45 Sensors combine the best of Banner's flexible Q45 sensor family with its reliable, field-proven, Sure Cross wireless architecture to solve new classes of applications limited only by the user's imagination. Containing a variety of sensor models, a radio, and internal battery supply, this product line is truly plug and play.

Key Features:

- Designed to interface with isolated dry contacts (push buttons), sourcing outputs, or NAMUR inductive proximity sensors
- IP67-rated housing for use in demanding environments
- 2.4 GHz ISM band radio meets worldwide standards

Applications:

- Door monitoring
- Call-for-parts
- Presence sensing
- Parts in position

Q45RD Remote Device, Battery Power

Models	I/O	Connector	Frequency	Environmental Rating
DX80N9Q45RD	Radio Function: Red and green light Input 1 Active: Amber Light	Female connector embedded in the front	900 MHz	IP67, NEMA 6P
DX80N2Q45RD		Female connector embedded in the front	2.4 GHz	
DX80N2Q45RD-QPF-0.5		18 inch female pigtail	2.4 GHz	

Q45RD Specifications

	900 MHz	2.4 GHz
Radio Range	Up to 3.2 Km (2 miles) with line of sight	Up to 1000 m (3280 ft) with line of sight
Minimum Separation Distance	4.57 m (15 ft)	0.3 m (1 ft)
Transmit Power	1W (25 dBm)	65 mW EIRP
Compliance	FCC ID UE3RM1809 - This device complies with FCC Part 15, Subpart C, 15.247 ETSI EN 300 328 V1.8.1 IC: 7044A-RM1809	FCC ID UE300DX80-2400 - This device complies with FCC Part 15, Subpart C, 15.247 ETSI/EN: In accordance with EN 300 328: V1.8.1 (2012-04) IC: 7044A-DX8024
Spread Spectrum Technology	FHSS (Frequency Hopping Spread Spectrum)	
Externally Powered Sourcing Sensors	ON Condition: 2 V to 5 V OFF Condition: Less than 1 V	
Construction	Molded reinforced thermoplastic polyester housing, oring-sealed transparent Lexan® cover, molded acrylic lenses, and stainless steel hardware. Q45s are designed to withstand 1200 psi washdown.	
Indicators	Red and green LEDs (radio function); amber LED indicates when input 1 is active	
Environmental Rating	NEMA 6P, IEC IP67	
Battery Life	See Datasheet	
Default Sample Rate	62.5 milliseconds (dry contact) or 125 milliseconds (NAMUR)	
Report Rate	On Change of State	
Operating Conditions	-40 °C to 70 °C (-40 °F to 158 °F); 90% relative humidity at 50 °C (non-condensing)	
Certifications		

Photoelectric Q45 Sensors





Q45 Sensors

The Sure Cross® Q45 is the first self-contained wireless standard photoelectric solution for the most challenging control and monitoring needs. Easily add a scalable wireless sensor network to improve efficiency by monitoring and coordinating multiple machines and processes without pulling cables.



Key Features:

- True self-contained wireless with no cables, cordsets or external power
- 1 km line-of-sight
- Built-in antenna
- 2.4 GHz unlicensed frequency
- Used exclusively with Banner's DX80 Gateways

Retroreflective Q45 Wireless

Sensing Mode	Models	Sensing Range	Wireless Communication Range	Output
	DX80N2Q45LP  Visible Red LED	6 m	1,000 m (with line of sight)	Discrete output via Gateway

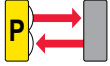

Diffuse Q45 Wireless

	DX80N2Q45D  Visible Red LED	300 mm	1,000 m (with line of sight)	Discrete output via Gateway
---	--	--------	---------------------------------	-----------------------------

Convergent Q45 Wireless

	DX80N2Q45CV  Visible Red LED	38 mm	1,000 m (with line of sight)	Discrete output via Gateway
---	---	-------	---------------------------------	-----------------------------

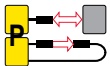
Fiber Optic (Glass) Q45 Wireless

	DX80N2Q45F  Visible Red LED	Sensing range varies by selected fiber	1,000 m (with line of sight)	Discrete output via Gateway
--	--	--	---------------------------------	-----------------------------

Photoelectric Q45 Sensor Specifications

Radio (2.4 GHz)	Range: Up to 1000 m (3280 ft) with line of sight Transmit Power: 65 mW EIRP
2.4 GHz Compliance	FCC ID UE300DX80-2400 - This device complies with FCC Part 15, Subpart C, 15.247 ETSI/EN: In accordance with EN 300 328: V1.8.1 (2012-04) IC: 7044A-DX8024
Spread Spectrum Technology	FHSS (Frequency Hopping Spread Spectrum)
Construction	Molded reinforced thermoplastic polyester housing, oring-sealed transparent Lexan® cover, molded acrylic lenses, and stainless steel hardware. Q45s are designed to withstand 1200 psi washdown.
Typical Battery Life	Up to 2 years, typical A typical battery life assumes an average of 10 seconds between sensor changes of state and the default 62.5 millisecond sample rate. Battery life is reduced to 1 year with an average of 1 second between changes of state.
Default Sensing Interval	62.5 milliseconds
Adjustments	Multi-turn sensitivity control (allows precise sensitivity setting - turn clockwise to increase gain.
Sensing Range	Retroreflective: 0.15 m to 6 m (6 in to 20 ft) Diffuse: 101 mm to 300 mm (4 in to 12 in) Opposed: Up to 30 m (100 ft) depending on Excess Gain requirements Glass Fiber Optic: 1½-in focal point
Report Rate	On Change of State
Indicators	Red and green LEDs (radio function); amber LED (only for alignment mode)
Environmental Rating	NEMA 6P, IEC IP67
Operating Conditions	-40 °C to 70 °C (-40 °F to 158 °F); 90% relative humidity at 50 °C (non-condensing)

Wireless Tower Light

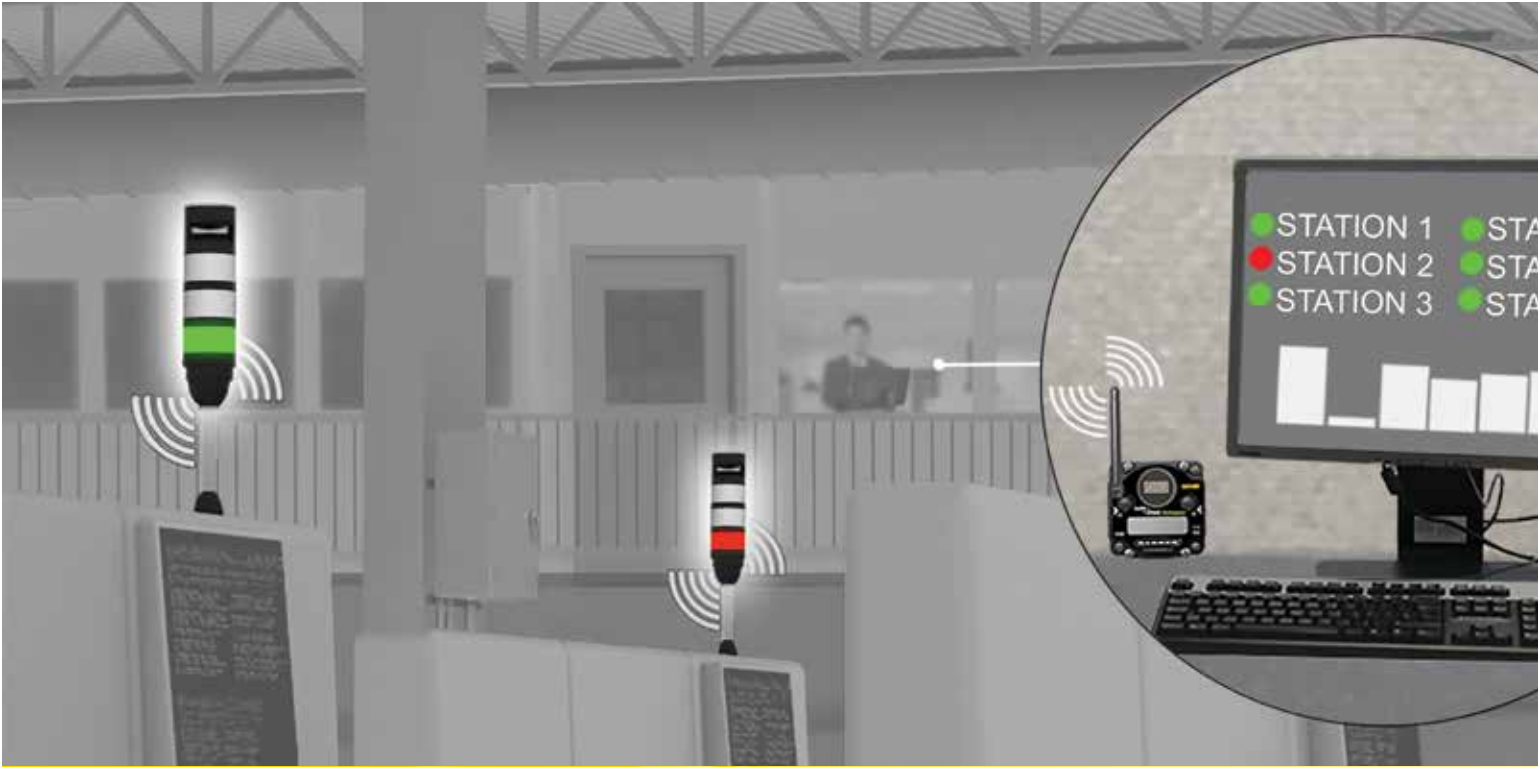

TL70

Monitor where you couldn't before: Effectively manage your factory visually without the cost of wiring.

Key Features:

- Save money and time – eliminate costly and time-consuming wire runs
- Scalable all-in-one solution with two-way wireless communication and visual status indication
- Improve productivity with a clear, easy-to-read signal tower light
- Use in harsh environments with rugged, water-resistant IP65 housing with UV-stabilized material
- Segments appear gray when off to eliminate false indication from ambient light

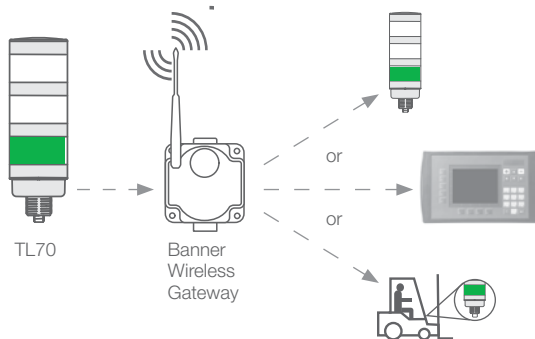

1-Way Communication

The TL70 relays machine status to a remote device

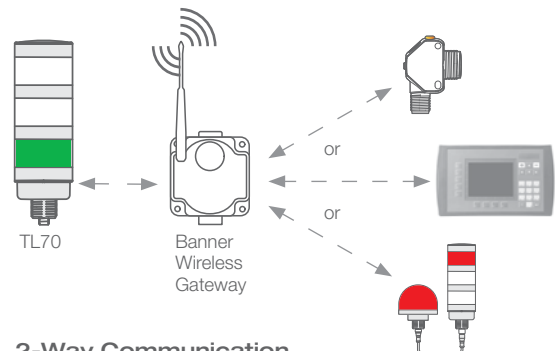

2-Way Communication

The TL70 relays a status to a remote device AND receives input from a remote device

Order Preassembled

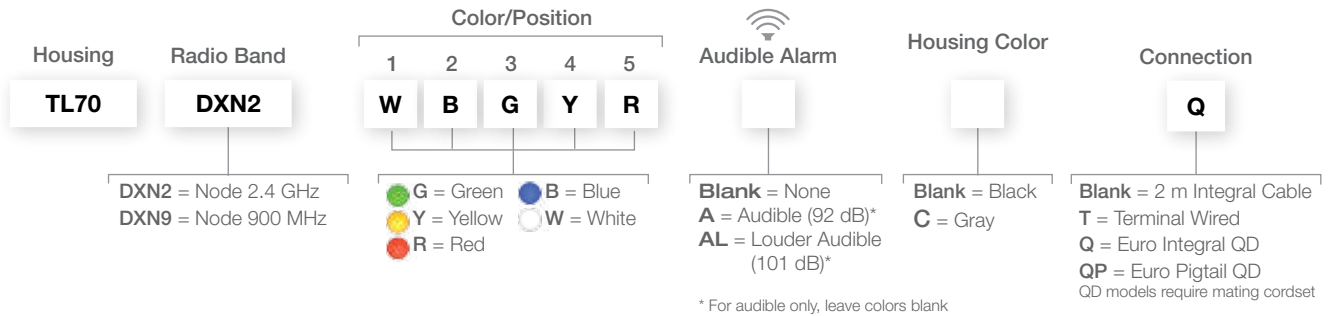

Order Components to Build your Own

TL70 Base

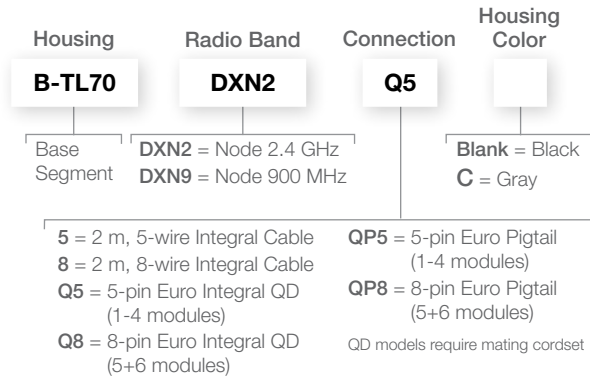

TL70 Light Segments

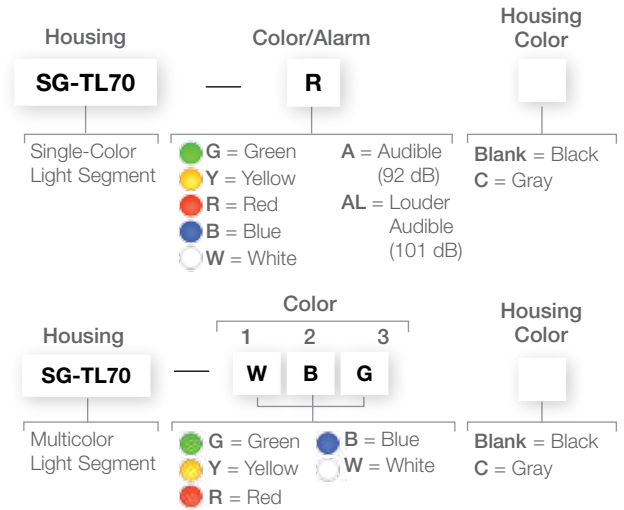

TL70 Wireless Tower Light Specifications

Supply Voltage	12 to 30 V dc (Outside the USA: 12 to 24 V dc, ± 10%)	
Supply Protection Circuitry	Protected against transient voltages	
Indicator Response Time	OFF Response: 150 µs (maximum) at 12 to 30 V dc ON Response: 180 ms (maximum) at 12 V dc; 50 ms (maximum) at 30 V dc	
Audible Alarm	2.6 KHz ± 250 Hz oscillation frequency; maximum intensity 92 dB (Audible) and 101dB (Louder Audible) at 1 m (3.3 ft) (typical)	
Indicators	1 to 5 colors depending on model: Green, Red, Yellow, Blue, and White Flash rates: 1.5 Hz ±10% and 3 Hz ±10% LEDs are independently selected	
Construction	Bases, segments, covers: polycarbonate	
Operating Conditions	-40 °C to +50 °C (-40 °F to +122 °F) 95% at +50 °C maximum relative humidity (non-condensing)	
Environmental Rating	IEC IP65	
Vibration and Mechanical Shock	Vibration 10 to 55 Hz 0.5 mm p-p amplitude per IEC60068-2-6 Shock 15G 11 ms duration, half sine wave per IEC60068-2-27	
Radio Range	900 MHz, 1 W: Up to 9.6 km (6 miles)	2.4 GHz, 65 mW: Up to 3.2 km (2 miles)
Minimum Separation Distance	900 MHz 1 W: 4.57 m (15 ft)	2.4 GHz 65 mW: 0.3 m (1 ft)
Radio Transmit Power	900 MHz, 1 W: 30 dBm (1 W) conducted (up to 36 dBm EIRP)	2.4 GHz, 65 mW: 18 dBm (65 mW) conducted, ≤ 20 dBm (100 mW) EIRP
Compliance	900 MHz Compliance (1 Watt) FCC ID UE3RM1809: This device complies with FCC Part 15, Subpart C, 15.247 IC: 7044A-RM1809	2.4 GHz Compliance FCC ID UE300DX80-2400 - This device complies with FCC Part 15, Subpart C, 15.247 ETSI EN 300 328 V1.8.1 (2012-06) IC: 7044A-DX8024
Radiated Immunity HF	10 V/m (EN 61000-4-3)	
Spread Spectrum Technology	FHSS (Frequency Hopping Spread Spectrum)	
Link Timeout	Gateway: Configurable via User Configuration Tool (UCT) software	Node: Defined by Gateway
Certifications		

Vehicle Detection Sensor



Ultrasonic Sensor Node



The Ultrasonic Sensor Node is ideal for indoor parking applications. Using sound waves to detect objects, it can be mounted directly on the ceiling of a parking garage to identify the presence of a car in the parking space below. The integrated D-cell battery reduces the cost of installation by eliminating the need to run wires and conduit.

Key Features:

- Wireless industrial I/O device with an Ultrasonic sensor integrated into the housing
- *FlexPower*® technology driven by one lithium primary battery integrated into the housing
- Power-efficient occupancy sensor for parking applications

Ultrasonic Nodes

Models	I/O	Frequency	Environmental Rating
DX80N9X1W0P0U	Inputs: One Ultrasonic, one temperature	900 MHz ISM Band	IP67, NEMA 6
DX80N2X1W0P0U		2.4 GHz ISM Band	

Ultrasonic MultiHop

DX80DR9M-HU	Inputs: Ultrasonic	900 MHz ISM Band	IP67, NEMA 6
DX80DR2M-HU		2.4 GHz ISM Band	

Ultrasonic Sensor Specifications

	Nodes	MultiHop
Radio Range	900 MHz: 300 meters (1000 ft) 2.4 GHz: 150 meters (500 ft)	900 MHz: 300 m (1000 ft) 2.4 GHz:
Radio Transmit Power	900 MHz: 21 dBm (150 mW) conducted 2.4 GHz: 18 dBm (65 mW) conducted, less than or equal to 20 dBm (100 mW) EIRP	
900 MHz Compliance (150 mW)	FCC ID TGUDX80 - This device complies with FCC Part 15, Subpart C, 15.247 IC: 7044A-DX8009	
2.4 GHz Compliance	FCC ID UE300DX80-2400 - This device complies with FCC Part 15, Subpart C, 15.247 ETSI/EN: In accordance with EN 300 328: V1.8.1 (2012-04) IC: 7044A-DX8024	
Spread Spectrum Technology	FHSS (Frequency Hopping Spread Spectrum)	
Link Timeout	Gateway: Configurable via User Configuration Tool (UCT) software Node: Defined by Gateway	NA
Power Requirements	3.6 V dc low power option from an internal battery	
Housing	Polycarbonate housing and rotary dial cover; polyester labels; EDPM rubber cover gasket Weight: 0.30 kg (0.65 lbs) Mounting: #10 or M5 (SS M5 hardware included) Max. Tightening Torque: 0.56 N-m (5 lbf-in)	Polycarbonate housing and rotary dial cover; polyester labels; EDPM rubber cover gasket; nitrile rubber, non sulphur cured button covers Weight: 0.26 kg (0.57 lbs) Mounting: #10 or M5 (SS M5 hardware included) Max. Tightening Torque: 0.56 N-m (5 lbf-in)
Interface	Indicators: One bi-color LED	
Packet Size	NA	900 MHz: 175 bytes (85 Modbus registers) 2.4 GHz: 125 bytes (60 Modbus registers)
Intercharacter Timing	NA	3.5 milliseconds
Ultrasonic Inputs	Range: 600–4000 mm Sample Rate: 10 seconds Report Rate: 64 seconds or on Change of State	
Operating Conditions	Operating Temperature: –40 to 85 °C Operating Humidity: 95% max. relative (non-condensing) Radiated Immunity: 10 V/m, 80-2700 MHz (EN61000-6-2)	
Environmental Rating	IEC IP67; NEMA 6	
Shock and Vibration	IEC 68-2-6 and IEC 68-2-7 Shock: 30g, 11 millisecond half sine wave, 18 shocks	Vibration: 0.5 mm p-p, 10 to 60 Hz

Certifications



Vehicle Detection Sensor



M-GAGE™ Sensor Node



The M-GAGE sensor uses a passive sensing technology to detect large ferrous objects. The sensor measures the change in the Earth's natural magnetic field (ambient magnetic field) caused by the introduction of a ferromagnetic object. The M-GAGE provides an alternative replacement for inductive loop systems and needs no external control box. Its unique design allows quick installation within a core hole.

Key Features:

- Internal three-axis magnetoresistive-based technology senses three dimensional changes to the Earth's magnetic field caused by the presence of ferrous objects
- Designed to minimize the effects of temperature changes and destabilizing magnetic fields
- Sensor learns ambient background and stores settings in non-volatile memory
- Powered by a lithium battery pack integrated into the housing
- Fully potted and sealed housing contains the power source, sensor, and antenna for a completely wireless solution

M-GAGE Sensor Nodes

Models	Power	Frequency	Input
DX80N9X1W0P0ZT DX80N2X1W0P0ZT	Low Profile: 3 AA batteries integrated into the housing	900 MHz ISM Band 2.4 GHz ISM Band	Input: Internal M-GAGE™
DX80N9X1W0P0ZTD DX80N2X1W0P0ZTD	D-cell lithium battery integrated into the housing	900 MHz ISM Band 2.4 GHz ISM Band	

MultiHop M-GAGE

Models	Power	Frequency	Input
DX80DR9M-HMT DX80DR2M-HMT	Low Profile: 3 AA batteries integrated into the housing	900 MHz ISM Band 2.4 GHz ISM Band	Input: Internal M-GAGE™
DX80DR9M-HMD DX80DR9M-HMD	D-cell lithium battery integrated into the housing	900 MHz ISM Band 2.4 GHz ISM Band	

M-GAGE Specifications

	Nodes	MultiHop
Radio Range	300 m (1000 ft) depending on installation	900 MHz: 300 m (1000 ft) 2.4 GHz: 150 m (500 ft)
Radio Transmit Power	900 MHz: 20 dBm (100 mW) conducted 2.4 GHz, 65 mW: 18 dBm (65 mW) conducted, less than or equal to 20 dBm (100 mW) EIRP	
900 MHz Compliance (150 mW)	FCC ID TGUDX80 - This device complies with FCC Part 15, Subpart C, 15.247 IC: 7044A-DX8009	
2.4 GHz Compliance	FCC ID UE300DX80-2400 - This device complies with FCC Part 15, Subpart C, 15.247 ETSI/EN: In accordance with EN 300 328: V1.8.1 (2012-04) IC: 7044A-DX8024	
Spread Spectrum Technology	FHSS (Frequency Hopping Spread Spectrum)	
Link Timeout	Gateway: Configurable via User Configuration Tool (UCT) software Node: Defined by Gateway	NA
Power Requirements	Lithium battery integrated into the housing	
Housing	ABS Weight: 0.14 kg (0.3 lbs)	
Interface	Indicators: One bi-color LED	
M-GAGE Inputs	Input: Internal Magnetometer Sample Rate: 1 second Ambient Temperature Effect: Less than 0.5 milligauss/°C	Input: Internal Magnetometer Sample Rate: 250 milliseconds Report Rate: On Change of State Ambient Temperature Effect: Less than 0.5 milligauss/°C
Environmental Rating	IEC IP67; NEMA 6	
Operating Conditions	-40 °C to +85 °C (-40 °F to +185 °F) 95% maximum relative humidity (non-condensing)	
Radiated Immunity HF	10 V/m (EN 61000-4-3)	
Shock and Vibration	IEC 68-2-6 and IEC 68-2-27 Shock: 30g, 11 millisecond half sine wave, 18 shocks Vibration: 0.5 mm p-p, 10 to 60 Hz	
Certifications		





Simple Wire Replacement

Banner's simple wire replacement products easily replace discrete, analog, Serial and Ethernet signal wires without the need for set up software. They provide reliable signal and data transfer over long distances using a proprietary RF protocol and frequency hopping technology that makes for secure communications. Simple wire replacement products are easy to deploy, simple to use and provide the start of a flexible network that can be expanded as production needs change.

Sure Cross® PM SERIES



An I/O Radio network that combines long range line-of-sight coverage with ease of deployment and use.

Banner's PM Series provides a flexible network that easily sets up without software. Setting up a basic point-to-point network is as easy as pairing a cell phone to a headset. You can replace cables and extend the range of digital and analog signals with minimum effort.

Key Features:

- Menu-driven LCD user interface
- No software needed
- IP67-rated housing for demanding environments
- One Gateway is preconfigured to support up to six Nodes
- Choose from two I/O configurations
- Select from multiple I/O maps

PM2 Models

The wireless PM2 models have four selectable discrete inputs, four sourcing discrete outputs, and two analog inputs and outputs in both the Gateway and Node. The PM2 Gateway is pre-mapped to support up to two Nodes.



Gateways	Nodes	Frequency	I/O
DX80G9M6S-PM2	DX80N9X6S-PM2	900 MHz	4 Discrete IN, 4 Discrete OUT 2 Analog IN, 2 Analog OUT
DX80G9M6S-PM2C*	DX80N9X6S-PM2C*		
DX80G2M6S-PM2	DX80N2X6S-PM2	2.4 GHz	
DX80G2M6S-PM2C*	DX80N2X6S-PM2C*		

PM8 Models

The wireless PM8 models have six sourcing discrete inputs and six sourcing discrete outputs in both the Gateway and Node. The PM8 Gateway is pre-mapped to support up to 6 Nodes.

Gateways	Nodes	Frequency	I/O
DX80G9M6S-PM8	DX80N9X6S-PM8	900 MHz	6 Discrete IN, 6 Discrete OUT
DX80G9M6S-PM8C*	DX80N9X6S-PM8C*		
	DX80N9X6S-PM8L*		
DX80G2M6S-PM8	DX80N2X6S-PM8	2.4 GHz	
DX80G2M6S-PM8C*	DX80N2X6S-PM8C*		
	DX80N2X6S-PM8L*		

* Models ending in "C" are screw terminals. Models ending in "L" have no LCD.

PM2 and PM8 Gateways and Nodes Specifications

Radio Range	900 MHz (1 W): Up to 9.6 kilometers (6 miles)* 2.4 GHz (65 mW): Up to 3.2 kilometers (2 miles)* <small>*Line of sight with included 2 dB antenna</small>	
Minimum Separation Distance	900 MHz (1 W): 4.57 m (15 ft)	2.4 GHz (65 mW): 0.3 m (1 ft)
Transmit Power	900 MHz (1 Watt): 30 dBm (1 W) conducted (up to 36 dBm EIRP)	2.4 GHz: 18 dBm (65 mW) conducted, less than or equal to 20 dBm (100 mW) EIRP
900 MHz Compliance	FCC ID UE3RM1809: This device complies with FCC Part 15, Subpart C, 15.247 IC: 7044A-RM1809	
2.4 GHz Compliance	FCC ID UE300DX80-2400 - This device complies with FCC Part 15, Subpart C, 15.247 ETSI/EN: In accordance with EN 300 328: V1.8.1 (2012-06) IC: 7044A-DX8024	
Spread Spectrum Technology	FHSS (Frequency Hopping Spread Spectrum)	
Linked Timeout	Gateway: Configurable via User Configuration Tool (UCT) software	Node: Defined by Gateway
Communication Hardware (RS-485) - Gateways Only	Interface: 2-wire half duplex RS-485 Baud rates: 9.6k, 19.2k (default), or 38.4k Data format: 8 data bits, no parity, 1 stop bit NOTE: Battery life is reduced to 1 year when the sample/report rate is increased to 16 seconds	
Communication Protocol	Modbus RTU	
Supply Voltage	10 to 30 V dc (Outside the USA: 12 to 24 V dc, ±10%) 900 MHz Consumption: Maximum current draw is < 100 mA and typical current draw is < 50 mA at 24 V dc (2.4 GHz consumption is less)	
Construction	Polycarbonate housing and rotary dial cover; polyester labels; EDPM rubber cover gasket; nitrile rubber, non-sulphur cured button covers Weight: 0.26 kg (0.57 lbs) Mounting: #10 or M5 (SS M5 hardware included) Max. Tightening Torque: 0.56 N-m (5 lbf-in)	
Antenna Connection	Ext. Reverse Polarity SMA, 50 Ohms Max Tightening Torque: 0.45 N-m (4 lbf-in)	
Interface	Indicators: Two bi-color LEDs	Buttons: Two Display: Six character LCD
Wiring Access	Two 1/2-in NPT ports	
Environmental Rating	PM2 and PM8 Models: IEC IP67; NEMA 6	PM2C and PM8C Models: IP20; NEMA 1
Operating Conditions	Temperature: -40 °C to +85 °C (-40 °F to +185 °F) (Electronics); -20 °C to +80 °C (-4 °F to +176 °F) (LCD) Humidity: 95% max. relative (non-condensing) Radiated Immunity: 10 V/m, 80-2700 MHz (EN61000-4-3)	
Shock and Vibration	IEC 68-2-6 and IEC 68-2-27 Shock: 30g, 11 millisecond half sine wave, 18 shocks Vibration: 0.5 mm p-p, 10 to 60 Hz	

Certifications



Sure Cross[®] PM Kit

Simple wire replacement is even simpler with Banner's fully integrated kit.

Plug-and-play with one Gateway and one Node, pre-bound and mapped to solve your first wireless challenge, and provide the start of a flexible network that can be expanded as production needs change.

Key Features:

- Pre-bound and mapped expandable bi-directional radios
- Eight LCD menu selectable I/O mapping options
- IP67-rated housing for demanding environments
- One Gateway is preconfigured to support up to six Nodes

Kits

DX80K*M6-PM2

4 Discrete IN, 4 Discrete OUT
2 Analog IN, 2 Analog OUT

DX80K*M6-PM8

6 Discrete IN, 6 Discrete OUT

* 9 for 900 MHz or 2 for 2.4 GHz



Performance Board Modules



Sure Cross® Performance Embeddable Board Modules were specifically designed for the needs of industrial users to provide connectivity where traditional wired connections are not possible or cost prohibitive. Performance Embeddable Board Modules communicate with all Sure Cross Performance radios.

Key Features:

- Simple yet highly expandable
- Supports Point-to-Point and Star network topologies
- DIP switch mapping for up to two Nodes

PB2 Gateways

Models	Frequency	I/O
DX80G9M6S-PB2	900 MHz	Inputs: Two sourcing discrete & two 0-20 mA analog Outputs: Two sourcing discrete & two 0-20 mA analog
DX80G2M6S-PB2	2.4 GHz	



point-to-point point-to-multipoint



star

PB1 and PB2 Nodes

Models	Frequency	I/O
DX80N9X2S-PB1	900 MHz	Inputs: Four sourcing discrete & two 0-20 mA analog Outputs: Four sourcing discrete & two 0-20 mA analog
DX80N2X2S-PB1	2.4 GHz	
DX80N9X6S-PB2	900 MHz	Inputs: Two sourcing discrete & two 0-20 mA analog Outputs: Two sourcing discrete & two 0-20 mA analog
DX80N2X6S-PB2	2.4 GHz	

PB2 Gateway and Node Specifications

Radio Range	900 MHz (1 Watt): Up to 9.6 kilometers (6 miles)* 2.4 GHz (65 mW): Up to 3.2 kilometers (2 miles)* *Line of sight with included 2 dB antenna
Minimum Separation Distance	900 MHz (1 Watt): 4.57 m (15 ft) 2.4 GHz (65 mW): 0.3 m (1 ft)
Transmit Power	900 MHz (1 Watt): 30 dBm (1 W) conducted (up to 36 dBm EIRP) 2.4 GHz: 18 dBm (65 mW) conducted, less than or equal to 20 dBm (100 mW) EIRP
900 MHz Compliance	FCC ID UE3RM1809: This device complies with FCC Part 15, Subpart C, 15.247 IC: 7044A-RM1809
2.4 GHz Compliance	FCC ID UE300DX80-2400 - This device complies with FCC Part 15, Subpart C, 15.247 ETSI/EN: In accordance with EN 300 328: V1.8.1 (2012-06) IC: 7044A-DX8024
Spread Spectrum Technology	FHSS (Frequency Hopping Spread Spectrum)
Supply Voltage	10 to 30 V dc (Outside the USA: 12 to 24 V dc, $\pm 10\%$) 900 MHz Consumption: Maximum current draw is < 100 mA and typical current draw is < 50 mA at 24 V dc (2.4 GHz consumption is less)
Current Draw (at 24 V dc)	900 MHz, 1 Watt: Approx. 3.5 mA 900 MHz, 250 mW: Approx. 1.5 mA 2.4 GHz, 65 mW: Approx. 3.5 mA
Interface	Indicators: One bi-color LEDs Buttons: One
Wiring Access	Terminal block
Antenna Connection	Ext. Reverse Polarity SMA, 50 Ohms; Max Tightening Torque: 0.45 N-m (4 lbf-in) U.FL-R-SMT.(01); Use cable BWA-HW-030 (U.FL to RP-SMA) or the equivalent
Linked Timeout	Gateway: Configurable via User Configuration Tool (UCT) software Node: Defined by Gateway
Operating Conditions	Temperature: $-40\text{ }^{\circ}\text{C}$ to $+85\text{ }^{\circ}\text{C}$ ($-40\text{ }^{\circ}\text{F}$ to $+185\text{ }^{\circ}\text{F}$) Humidity: 95% max. relative (non-condensing)
Radiated Immunity	10 V/m, 80-2700 MHz (EN61000-4-3)

Serial Data Radio

Sure Cross® MultiHop Serial Data Radios are wireless industrial communication devices used to extend the range of serial communication networks.

Key Features:

- DIP switches select operational modes: master, repeater or slave
- No software required for deployment
- Serial communication style (RS-232 or RS-485) is user-selectable

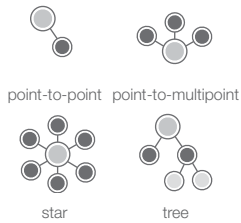

Models	Frequency	Range	Environmental Rating
DX80SR9M-H	900 MHz	6 miles*	IP67, NEMA 6
DX80SR2M-H	2.4 GHz	2 miles*	IP67, NEMA 6

Serial Data Radio Specifications

Radio Range	900 MHz (1 Watt): Up to 9.6 kilometers (6 miles)* 2.4 GHz (65 mW): Up to 3.2 kilometers (2 miles)* *Line of sight with included 2 dB antenna
Minimum Separation Distance	900 MHz (1 Watt): 4.57 m (15 ft) 2.4 GHz (65 mW): 0.3 m (1 ft)
Transmit Power	900 MHz (1 Watt): 30 dBm (1 W) conducted (up to 36 dBm EIRP) 2.4 GHz: 18 dBm (65 mW) conducted, less than or equal to 20 dBm (100 mW) EIRP
900 MHz Compliance	FCC ID UE3RM1809: This device complies with FCC Part 15, Subpart C, 15.247 IC: 7044A-RM1809
2.4 GHz Compliance	FCC ID UE300DX80-2400 - This device complies with FCC Part 15, Subpart C, 15.247 ETSI/EN: In accordance with EN 300 328: V1.8.1 (2012-04) IC: 7044A-DX8024
Spread Spectrum Technology	FHSS (Frequency Hopping Spread Spectrum)
Supply Voltage	10 to 30 V dc (Outside the USA: 12 to 24 V dc, ±10%)
Current Draw	Idle: At 30 V dc: 0.011 A At 24 V dc: 0.012 A At 10 V dc: 0.020 A Transmitting: At 30 V dc: 0.007 A At 24 V dc: 0.008 A At 10 V dc: 0.011 A
Housing	Polycarbonate housing and rotary dial cover; polyester labels; EDPM rubber cover gasket; nitrile rubber, non-sulphur cured button covers Weight: 0.26 kg (0.57 lbs) Mounting: #10 or M5 (SS M5 hardware included) Max. Tightening Torque: 0.56 N·m (5 lbf·in)
Interface	Indicators: Two bi-color LEDs Buttons: One (under small round cover)
Wiring Access	4-position terminal
Antenna Connection	Ext. Reverse Polarity SMA, 50 Ohms Max Tightening Torque: 0.45 N·m (4 lbf·in)
Hardware (Serial Data Radio SRxM-H)	Interface: 2-wire half-duplex RS-485 (default) or RS-232 Baud rates: 1200, 2400, 9600, 19.2k (default), 38.4k, 57.6k, 115.2k Data format: 8 data bits, 1 stop bit, no parity (default), even parity, odd parity
Packet Size (Serial Data Radio)	1500 bytes maximum
Wireless Data Transfer Rate	900 MHz: 300 kbps 2.4 GHz: 250 kbps
Environmental Rating	IEC IP67; NEMA 6
Operating Conditions	Operating Temperature: -40 °C to +85 °C (-40 °F to +185 °F) (Electronics); -20 °C to +80 °C (-4 °F to +176 °F) (LCD) Operating Humidity: 95% max. relative (non-condensing) Radiated Immunity: 10 V/m, 80-2700 MHz (EN61000-6-2)
Shock and Vibration	IEC 68-2-6 and IEC 68-2-27 Shock: 30g, 11 millisecond half sine wave, 18 shocks Vibration: 0.5 mm p-p, 10 to 60 Hz

Ethernet Data Radio



Sure Cross® MultiHop Ethernet Data Radios are wireless industrial communication devices used to create point-to-multipoint configurations of wireless Ethernet networks.

Key Features:

- No IP address configuration is required
- Self-healing, auto-routing RF network with multiple hops extends the network's range
- DIP switches select operational modes: master, repeater or slave
- Built-in site survey mode enables rapid assessment of a location's RF transmission properties

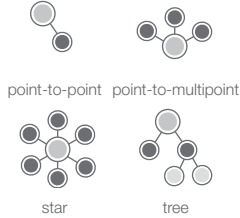

Models	Frequency	Range	Environmental Rating
DX80ER9M-H	900 MHz	6 miles	IP20, NEMA 1
DX80ER2M-H	2.4 GHz	2 miles	IP20, NEMA 1

Ethernet Data Radio Specifications

Radio Range	900 MHz (1 Watt): Up to 9.6 kilometers (6 miles)* 2.4 GHz (65 mW): Up to 3.2 kilometers (2 miles)* *Line of sight with included 2 dB antenna
Transmit Power	900 MHz, 1 Watt: 30 dBm (1 W) conducted (up to 36 dBm EIRP) 2.4 GHz, 65 mW: 18 dBm (65 mW) conducted, less than or equal to 20 dBm (100 mW) EIRP
Receive Sensitivity	900 MHz: -104 dBm at 300 kbps; -107 dBm at 200 kbps; -108 dBm at 100 kbps 2.4 GHz: -104 dBm at 250 kbps
Minimum Separation Distance	900 MHz (1 Watt): 4.57 m (15 ft) 2.4 GHz (65 mW): 0.3 m (1 ft)
900 MHz Compliance	FCC ID UE3RM1809: This device complies with FCC Part 15, Subpart C, 15.247 IC: 7044A-RM1809
2.4 GHz Compliance	FCC ID UE300DX80-2400 - This device complies with FCC Part 15, Subpart C, 15.247 ETSI/EN: In accordance with EN 300 328: V1.7.1 (2006-05) IC: 7044A-DX8024
Spread Spectrum Technology	FHSS (Frequency Hopping Spread Spectrum)
Communication	Ethernet: 10/100 baseT Ethernet RJ45 connection Radio: 200kbps to 300kbps Encryption: AES (Advanced Encryption Standard) using a 256-bit cryptographic key
Supply Voltage	10 to 30 V dc (Outside the USA: 12 to 24 V dc, ±10%) on the brown wire, or 3.6 to 5.5 V dc low power option on the gray wire
Current Consumption	Idle: 50 mA at 24 V; 100 mA at 12 V; 170 mA at 5 V Transmit 250 mW: 60 mA at 24V ; 120 mA at 12 V; 200 mA at 5 V Transmit 1 Watt: 70 mA at 24 V; 130 mA at 12 V; 240 mA at 5 V
Housing	Polycarbonate housing and rotary dial cover; polyester labels; EDPM rubber cover gasket; nitrile rubber, non-sulphur cured button covers Weight: 0.26 kg (0.57 lbs) Mounting: #10 or M5 (SS M5 hardware included) Max. Tightening Torque: 0.56 N·m (5 lbf·in)
Antenna Connection	Ext. Reverse Polarity SMA, 50 Ohms Max Tightening Torque: 0.45 N·m (4 lbf·in)
Interface	Indicators: Two bi-color LEDs Buttons: Two Display: Six character LCD
Environmental Rating	IEC IP20; NEMA 1
Operating Conditions	-40 °C to +85 °C (-40 °F to +185 °F) (Electronics); -20 °C to +80 °C (-4 °F to +176 °F) (LCD) 95% maximum relative humidity (non-condensing) Radiated Immunity: 10 V/m (EN 61000-4-3)
Shock and Vibration	IEC 68-2-6 and IEC 68-2-27 Shock: 30g, 11 millisecond half sine wave, 18 shocks Vibration: 0.5 mm p-p, 10 to 60 Hz

DXER9 Ethernet Data Radio

Sure Cross® Ethernet Radio is an industrial grade, long range, 900 MHz radio used to create point-to-multipoint configurations of wireless Ethernet networks.

Key Features:

- DIP switches select operational modes
- FHSS radios operate and synchronize automatically
- RF transmission rate of 1.536 Mb/s and a throughput of 935 Kb/s
- 128 bit AES encryption for Ethernet data packets
- Point-to-multipoint configurations with up to 16 subscriber units



ER 900 MHz

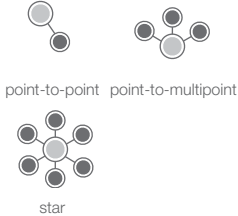

Models	Range	Transmit Range	Environmental Rating
DXER9	Up to 3 mile range	125 mW	IP55

Ethernet Data Radio Specifications

RF Transmission Rate	1.536 Mb/s
Ethernet Throughput	935 Kb/s
Output Power	+21 dBm (4 Watts EIRP used with 15 dBi antenna)
Receive Sensitivity	-97 dBm at 10e-4 BER (-112 dBm with 15 dBi antenna)
Radio Link Budget	148 dB with 15 dBi antenna
Range	Up to 3 miles
Radio Channels/Bandwidth	12 non-overlapping with 2.0833 MHz spacing and 1.75 MHz occupied bandwidth
Spread Spectrum Technology	Direct Sequence Spread Spectrum
Manual Frequency Select	Channel selected with DIP switch or via Web browser interface
Connector Types	Ext. Reverse Polarity SMA / 10-100 baseT Industrial Ethernet / 5-pin or 4-pin M12/Euro-style power connection
Status LEDs	Power, Ethernet Link, RF RX, RF TX, 4/Channel, and 6/Link Quality
Error Correction Technique	Sub-block error detection and retransmission
Adjacent-Band Rejection	SAW receiver filter attenuates cellular and pager interference
Regulator Type	Switching regulator
Browser Management Tools	QoS Statistics, Network Settings, Spectrum Analyzer, and Firmware Upgrading
Power Consumption	Transmit: 1.7 Watts Receive: 0.8 Watts
Voltage	Apply power using one of the following connections: Euro-style connector: 5 to 48 V dc with pin 1 positive and pin 3 ground
Temperature Range	-40 °C to 70 °C (-40 °F to +158 °F)
Mounting	#10 or M5 (M5 hardware included)
M5 Fasteners Max Tightening Torque	0.56 N·m (5 in-lbf)
Material	Case: PBT
Environmental Rating	IEC IP65; NEMA 4X
Certifications	 IND. CONT. EQ. 447Y Maximum ambient temperature: 70 °C Power rating: UL Class 2 Enclosure environmental rating: UL Type 1





Wireless I/O, Data and Network Connectivity

Banner's network radios provide the backbone of a very flexible and highly expandable wireless network for industrial environments. The Performance Series centers around a Gateway and up to 47 remotely located Nodes with multiple I/O options. The MultiHop Series uses repeaters to extend the range of the network using multiple "hops" to cover larger distances or to circumvent obstacles (trees, buildings, topology, etc.).

Performance Series—Gateways



Create point-to-multipoint networks that distribute I/O over large areas. Input and output types include discrete (dry contact, PNP/NPN), analog (0 to 10 V dc, 0 to 20 mA), temperature (thermocouple and RTD), and pulse counter.

Key Features:

- Enhanced Gateways offer increased range in the 900 MHz frequency band
- High density I/O capacity provides up to 12 discrete inputs or outputs or a mix of discrete and analog I/O
- Universal analog inputs allow current or voltage to be selected in the field

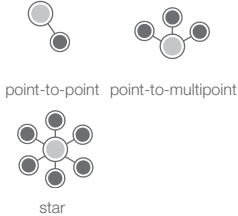

DX80 Performance Gateways, 10-30 V DC

Models	I/O	Frequency	Housing
DX80G9M2S-P	N/A	900 MHz	Low Profile
DX80G2M2S-P		2.4 GHz	
DX80G9M6S-P2	Inputs: Four selectable discrete, two 0–20 mA or 0–10 V analog Outputs: Four sourcing discrete, two 0–20mA analog	900 MHz	IP67
DX80G2M6S-P2		2.4 GHz	
DX80G9M2S-P7	Inputs/Outputs: Up to 12 NPN inputs or up to 12 NMOS outputs, or a mix of inputs and outputs not exceeding 12 I/O points	900 MHz	IP67
DX80G2M2S-P7		2.4 GHz	
DX80G9M6S-P8	Inputs/Outputs: Up to 12 PNP inputs or up to 12 PNP outputs, or a mix of inputs and outputs not exceeding 12 I/O points	900 MHz	IP67
DX80G2M6S-P8		2.4 GHz	



DX80 Performance Gateways, Board Models Only 10-30 V DC

Models	I/O	Frequency	Housing
DX80G9M6S-PB2	Inputs: Two sourcing discrete, two 0-20 mA analog Outputs: Two sourcing discrete, two 0-20 mA analog	900 MHz	Low Profile
DX80G2M6S-PB2		2.4 GHz	

DX80 Performance Gateway Specifications*

Radio Range	900 MHz, 1 Watt: Up to 9.6 km (6 miles)	2.4 GHz, 65 mW: Up to 3.2 km (2 miles)		
Minimum Separation Distance	900 MHz, 1 Watt: 4.57 m (15 ft)	2.4 GHz, 65 mW: 0.3 m (1 ft)		
Radio Transmit Power	900 MHz, 1 Watt: 30 dBm (1 W) conducted (up to 36 dBm EIRP)	2.4 GHz, 65 mW: 18 dBm (65 mW) conducted, less than or equal to 20 dBm (100 mW) EIRP		
Compliance	900 MHz Compliance (1 Watt) FCC ID UE3RM1809: This device complies with FCC Part 15, Subpart C, 15.247 IC: 7044A-RM1809	2.4 GHz Compliance FCC ID UE300DX80-2400 - This device complies with FCC Part 15, Subpart C, 15.247 ETSI/EN: In accordance with EN 300 328: V1..1 (2012-06) IC: 7044A-DX8024		
Spread Spectrum Technology	FHSS (Frequency Hopping Spread Spectrum)			
Communication Hardware	Interface: 2-wire half-duplex RS-485 Baud rates: 9.6k, 19.2k (default), or 38.4k via DIP switches Data format: 8 data bits, no parity, 1 stop bit			
Communication Protocol	Modbus RTU			
Link Timeout	Gateway: Configurable via User Configuration Tool (UCT) software Node: Defined by Gateway			
RTD Inputs	Sample Rate: 1 second	Report Rate: 16 seconds	Accuracy: 0.1% of full scale	Resolution: 0.1 °C, 15-bit
Operating Conditions	-40 °C to +85 °C (-40 °F to +185 °F) (Electronics); -20 °C to +80 °C (-4 °F to +176 °F) (LCD) 95% maximum relative humidity (non-condensing) Radiated Immunity: 10 V/m (EN 61000-4-3)			
Shock and Vibration	IEC 68-2-6 and IEC 68-2-27	Shock: 30g, 11 millisecond half sine wave, 18 shocks	Vibration: 0.5 mm p-p, 10 to 60 Hz	
Supply Voltage	DX80 and "C" Housing Models: 10 to 30 V dc or 3.6 to 5.5 V dc low power option (Outside the USA: 12 to 24 V dc, ±10% or 3.6 to 5.5 V dc low power option) 900 MHz Consumption: Maximum current draw is < 40 mA and typical current draw is < 30 mA at 24 V dc. (2.4 GHz consumption is less)			
Construction	Polycarbonate housing and rotary dial cover; polyester labels; EDPM rubber cover gasket; nitrile rubber, non-sulphur cured button covers Weight: 0.26 kg (0.57 lbs) DX80 and "C" Housing Models: Mounting: #10 or M5 (SS M5 hardware included) Max. Tightening Torque: 0.56 N·m (5 lbf·in)			
Antenna Connection	Ext. Reverse Polarity SMA, 50 Ohms	Max Tightening Torque: 0.45 N·m (4 lbf·in)		
Interface	Indicators: Two bi-color LEDs	Buttons: Two	Display: Six character LCD	
Wiring Access	DX80 Housing Models: Four PG-7, One 1/2-in NPT, One 5-pin threaded M12/Euro-style male quick-disconnect "C" Housing Models: External terminals			
Environmental Rating	DX80 models: IEC IP67; NEMA 6 "C" Housing Models: IEC IP20; NEMA 1			
Certifications				

* See datasheet for model specific details

Performance Series—Nodes



Create point-to-multipoint networks that distribute I/O over large areas. Input and output types include discrete (dry contact, PNP/NPN), analog (0 to 10 V dc, 0 to 20 mA), temperature (thermocouple and RTD), and pulse counter.

Key Features:

- Enhanced Nodes offer increased range in the 900 MHz frequency band
- High density I/O capacity provides up to 12 discrete inputs or outputs or a mix of discrete and analog I/O
- Universal analog inputs allow current or voltage to be selected in the field



Low Profile



IP67 Housing



IP20 Housing

DX80 Performance Nodes

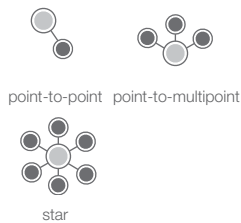

Models	I/O	Voltage	Frequency
DX80N9X2S-P1	Discrete Mode Inputs: Two selectable discrete and two thermistor Outputs: Two NMOS discrete Switch Power: Two	10-30 V dc	900 MHz
DX80N2X2S-P1			2.4 GHz
DX80N9X1S-P1E	Analog Mode Inputs: Two selectable discrete, two analog (0-20 mA or 0-10 V), and two thermistor Outputs: Two NMOS discrete Switch Power: One	Battery	900 MHz
DX80N2X1S-P1E			2.4 GHz
DX80N9X6S-P2	Inputs: Four selectable discrete, two 0-20 mA or 0-10 V (universal) analog Outputs: Four PNP discrete, two 0-20mA analog	10-30 V dc	900 MHz
DX80N2X6S-P2			2.4 GHz
DX80N9X2S-P3	Inputs: Two selectable discrete, four thermocouple, one thermistor for CJC Outputs: One NMOS discrete	10-30 V dc	900 MHz
DX80N2X2S-P3			2.4 GHz
DX80N9X1S-P3E		Battery	900 MHz
DX80N2X1S-P3E			2.4 GHz
DX80N9X2S-P4	Inputs: Four 3-wire RTDs	10-30 V dc	900 MHz
DX80N9X1S-P4E		Battery	2.4 GHz
DX80N9X2S-P5	Inputs: Two NPN discrete, four selectable analog (0-20 mA or 0-10 V) Outputs: Two NMOS discrete Switch Power: Two	10-30 V dc	900 MHz
DX80N2X2S-P5			2.4 GHz
DX80N9X1S-P6	Inputs: 1-wire serial interface for one serial sensing device	Battery	900 MHz
DX80N2X1S-P6			2.4 GHz
DX80N9X6S-P6		10-30 V dc	900 MHz
DX80N2X6S-P6			2.4 GHz
DX80N9X2S-P7	Inputs/Outputs: Up to 12 NPN inputs or up to 12 NMOS outputs, or a mix of inputs and outputs not exceeding 12 I/O points	10-30 V dc	900 MHz
DX80N2X2S-P7			2.4 GHz
DX80N9X6S-P8	Inputs/Outputs: Up to 12 PNP inputs or up to 12 PNP outputs, or a mix of inputs and outputs not exceeding 12 I/O points	10-30 V dc	900 MHz
DX80N2X6S-P8			2.4 GHz
DX80N9X2S-DCLATCHE	Inputs: Two selectable discrete Outputs for DC Latch: DC Latch	Battery	900 MHz
DX80N2X2S-DCLATCHE			2.4 GHz



DX80 Performance Nodes, Board Models Only, 10-30 V DC

Models	I/O	Frequency
DX80N9X2S-PB1	Inputs: Two NPN discrete, two 0-20 mA analog Outputs: Two NMOS discrete Switch Power: Two	900 MHz
DX80N2X2S-PB1		2.4 GHz
DX80N9X6S-PB2	Inputs: Two PNP discrete, two 0-20 mA analog Outputs: Two PNP discrete, two 0-20 mA analog	900 MHz
DX80N2X6S-PB2		2.4 GHz

DX80 Performance Nodes Specifications*

Radio Range	900 MHz, 1 Watt: Up to 9.6 km (6 miles)	2.4 GHz, 65 mW: Up to 3.2 km (2 miles)
Minimum Separation Distance	900 MHz, 1 Watt: 4.57 m (15 ft)	2.4 GHz, 65 mW: 0.3 m (1 ft)
Radio Transmit Power	900 MHz, 1 Watt: 30 dBm (1 W) conducted (up to 36 dBm EIRP)	2.4 GHz, 65 mW: 18 dBm (65 mW) conducted, less than or equal to 20 dBm (100 mW) EIRP
Compliance	900 MHz Compliance (1 Watt) FCC ID UE3RM1809: This device complies with FCC Part 15, Subpart C, 15.247 IC: 7044A-RM1809	2.4 GHz Compliance FCC ID UE300DX80-2400 - This device complies with FCC Part 15, Subpart C, 15.247 ETSI/EN: In accordance with EN 300 328: V1.8.1 (2012-06) IC: 7044A-DX8024
Spread Spectrum Technology	FHSS (Frequency Hopping Spread Spectrum)	
Link Timeout	Gateway: Configurable via User Configuration Tool (UCT) software Node: Defined by Gateway	
Operating Conditions	-40 °C to +85 °C (-40 °F to +185 °F) (Electronics); -20 °C to +80 °C (-4 °F to +176 °F) (LCD) "E" Housing Models: -40 °C to +65 °C (-40 °F to +149 °F) (Electronics); -20 °C to +80 °C (-4 °F to +176 °F) (LCD) 95% maximum relative humidity (non-condensing) Radiated Immunity: 10 V/m (EN 61000-4-3)	
Shock and Vibration	IEC 68-2-6 and IEC 68-2-27	Shock: 30g, 11 millisecond half sine wave, 18 shocks Vibration: 0.5 mm p-p, 10 to 60 Hz
Supply Voltage	DX80 and "C" Housing Models: 10 to 30 V dc or 3.6 to 5.5 V dc low power option (Outside the USA: 12 to 24 V dc, ±10% or 3.6 to 5.5 V dc low power option) "E" Housing Models: 3.6 V dc low power option from an internal battery or 10 to 30 V dc 900 MHz Consumption: Maximum current draw is < 40 mA and typical current draw is < 30 mA at 24 V dc. (2.4 GHz consumption is less)	
Construction	Polycarbonate housing and rotary dial cover; polyester labels; EDPM rubber cover gasket; nitrile rubber, non-sulphur cured button covers Weight: 0.26 kg (0.57 lbs) DX80 and "C" Housing Models: Mounting: #10 or M5 (SS M5 hardware included) "E" Housing Models: Mounting: 1/4-in or M7 (SS M7 hardware included) Max. Tightening Torque: 0.56 N-m (5 lbf-in)	
Antenna Connection	Ext. Reverse Polarity SMA, 50 Ohms	Max Tightening Torque: 0.45 N-m (4 lbf-in)
Interface	Indicators: Two bi-color LEDs	Buttons: Two Display: Six character LCD
Wiring Access	DX80 Housing Models: Four PG-7, One 1/2-in NPT, One 5-pin threaded M12/Euro-style male quick-disconnect "C" Housing Models: External terminals "E" Housing Models: Two 1/2-in NPT	
Environmental Ratingw	DX80 models: IEC IP67; NEMA 6 "C" Housing Models: IEC IP20; NEMA 1 "E" Housing Models: IEC IP65; NEMA 4X	
Certifications		

* See datasheet for model specific details

Performance Series–P6 Nodes



The -P6 Performance Node is an industrial radio device with a 1-wire serial interface that is designed to transmit data from 1-wire serial sensors, such as the Banner Temperature and Humidity (M12FTH4Q) or Vibration and Temperature (QM42VT1) sensors.

Key Features:

- 1-wire serial interface
- Battery-powered models for a completely wireless solution
- Line-powered models for continuous sampling

Performance Series—Nodes

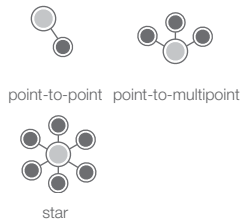

Models	Power	I/O	Frequency
DX80N9X1S-P6	D-cell Lithium battery	Inputs: 1-wire serial interface for one 1-wire serial sensing device	900 MHz
DX80N2X1S-P6			2.4 GHz
DX80N9X65-P6	10-30 V dc		900 MHz
DX80N9X65-P6			2.4 GHz

Used With

M12FTH4Q	see page 10	Temperature and relative humidity via a 1-wire serial interface
M12FT4Q	see page 10	Temperature via a 1-wire serial interface
QM42VT1	see page 8	Vibration and temperature via a 1-wire serial interface

DX80 Performance P6 Specifications

Radio Range	900 MHz, 1 Watt: Up to 9.6 km (6 miles)	2.4 GHz, 65 mW: Up to 3.2 km (2 miles)
Minimum Separation Distance	900 MHz, 1 Watt: 4.57 m (15 ft)	2.4 GHz, 65 mW: 0.3 m (1 ft)
Radio Transmit Power	900 MHz, 1 Watt: 30 dBm (1 W) conducted (up to 36 dBm EIRP)	2.4 GHz, 65 mW: 18 dBm (65 mW) conducted, less than or equal to 20 dBm (100 mW) EIRP
Compliance	900 MHz Compliance (1 Watt) FCC ID UE3RM1809: This device complies with FCC Part 15, Subpart C, 15.247 IC: 7044A-RM1809	2.4 GHz Compliance FCC ID UE300DX80-2400 - This device complies with FCC Part 15, Subpart C, 15.247 ETSI/EN: In accordance with EN 300 328: V1.8.1 (2012-06) IC: 7044A-DX8024
Spread Spectrum Technology	FHSS (Frequency Hopping Spread Spectrum)	
Link Timeout	Gateway: Configurable via User Configuration Tool (UCT) software Node: Defined by Gateway	
Operating Conditions	-40 °C to +85 °C (-40 °F to +185 °F) (Electronics); -20 °C to +80 °C (-4 °F to +176 °F) (LCD) 95% maximum relative humidity (non-condensing) Radiated Immunity: 10 V/m (EN 61000-4-3)	
Shock and Vibration	IEC 68-2-6 and IEC 68-2-27	Shock: 30g, 11 millisecond half sine wave, 18 shocks Vibration: 0.5 mm p-p, 10 to 60 Hz
Supply Voltage	Integrated battery models: 3.6 V dc low power option from an internal battery Non-battery models: 10 to 30 V dc (Outside the USA: 12 to 24 V dc, ±10%)	
Construction	Polycarbonate housing and rotary dial cover; polyester labels; EDPM rubber cover gasket; nitrile rubber, non-sulphur cured button covers Integrated battery models: Weight: 0.30 kg (0.65 lbs) Non-battery models: Weight: 0.26 kg (0.57 lbs) Mounting: #10 or M5 (SS M5 hardware included) Max. Tightening Torque: 0.56 N-m (5 lbf-in)	
Antenna Connection	Ext. Reverse Polarity SMA, 50 Ohms	Max Tightening Torque: 0.45 N-m (4 lbf-in)
Interface	Indicators: Two bi-color LEDs	Buttons: Two Display: Six character LCD
Wiring Access	Integrated battery models: One 5-pin threaded M12 Euro-style female quick-disconnect Non-battery models: One 5-pin threaded M12 Euro-style female quick-disconnect and one 5-pin threaded M12 Euro-style male quick-disconnect	
Environmental Rating	IEC IP67; NEMA 6	
Certifications		

MultiHop Modbus Radios



MultiHop Modbus Data Radios extend the range of Modbus or other serial communication networks. Each radio may be set to act as either a master, repeater or slave. Models are available with built in discrete and analog I/O, which can be accessed using the Modbus protocol.

Key Features:

- Self-healing, auto routing RF network with multiple hops extends the network's range
- Flexible: DIP switch selectable to be a master, repeater or slave
- User-selectable communication between RS-485 and RS-232

MultiHop Modbus Radios

Models	Transmit Power	Frequency
DX80DR9M-H	250 mW or 1 Watt (DIP switch selectable)	900 MHz
DX80DR2M-H	65 mW (100 mW EIRP)	2.4 GHz

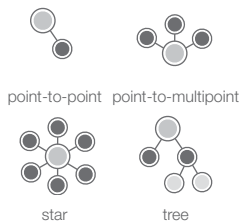

MultiHop Modbus Radios with I/O

Models	I/O	Voltage	Frequency	Housing
DX80DR9M-H1	Inputs: Four discrete, two 0-20 mA analog, one thermistor, one counter Outputs: Two NMOS discrete Switch Power: Two Serial interface: RS-485	10-30 V dc	900 MHz	IP67
DX80DR9M-H1E		Battery	900 MHz	IP54
DX80DR2M-H1		10-30 V dc	2.4 GHz	IP67
DX80DR2M-H1E		Battery	2.4 GHz	IP54
DX80DR9M-H2	Inputs: Four discrete, two 0-20 mA analog Outputs: Four sourcing discrete, two 0-20 mA analog Serial interface: RS-485	10-30 V dc	900 MHz	IP67
DX80DR2M-H2			2.4 GHz	
DX80DR9M-H3	Inputs: Two discrete, four thermocouple, one thermistor (internal) Outputs: Two NMOS discrete Serial interface: RS-232	10-30 V dc	900 MHz	IP67
DX80DR9M-H3E		Battery	2.4 GHz	IP54
DX80DR2M-H3		10-30 V dc	900 MHz	IP67
DX80DR2M-H3E		Battery	2.4 GHz	IP54
DX80DR9M-H4	Inputs: Four 3-wire Pt100 RTD Serial interface: RS-232	10-30 V dc	900 MHz	IP67
DX80DR9M-H4E		Battery	2.4 GHz	IP54
DX80DR2M-H4		10-30 V dc	900 MHz	IP67
DX80DR2M-H4E		Battery	2.4 GHz	IP54
DX80DR9M-H5	Inputs: Four sinking discrete, four 0-20 mA analog Outputs: Two NMOS discrete Switch Power: Two Serial Interface: RS-485	10-30 V dc	900 MHz	IP67
DX80DR2M-H5			2.4 GHz	
DX80DR9M-H6	Inputs: 1-wire serial interface for one 1-wire serial sensing device	Battery	900 MHz	IP67
DX80DR2M-H6			2.4 GHz	
DX80DR9M-H12	Inputs: Two discrete, two 0-20 mA analog, one thermistor, one SDI-12 or counter Outputs: Two NMOS discrete Switch Power: Two Serial interface: RS-485	10-30 V dc	900 MHz	IP67
DX80DR2M-H12			2.4 GHz	
DX80DR9M-DCLATCHE	Inputs: Two sinking discrete Outputs for DC Latch: DC Latch	Battery	900 MHz	IP54
DX80DR2M-DCLATCHE			2.4 GHz	

MultiHop Modbus Radios with I/O — Board Models

Models	I/O	Frequency
DX80DR9M-HB1	Inputs: Two sinking discrete, two 0 to 20 mA analog Outputs: Two NMOS discrete Switch Power Outputs: Two	900 MHz
DX80DR2M-HB1		2.4 GHz
DX80DR9M-HB2	Inputs: Two sourcing discrete, two 0 to 20 mA analog Outputs: Two sourcing discrete, two 0 to 20 mA analog	900 MHz
DX80DR2M-HB2		2.4 GHz

MultiHop Modbus Radios with I/O Specifications*

Radio Range	900 MHz, 1 Watt: Up to 9.6 km (6 miles)	2.4 GHz, 65 mW: Up to 3.2 km (2 miles)
Minimum Separation Distance	900 MHz, 1 Watt: 4.57 m (15 ft)	2.4 GHz, 65 mW: 0.3 m (1 ft)
Radio Transmit Power	900 MHz, 1 Watt: 30 dBm (1 W) conducted (up to 36 dBm EIRP)	2.4 GHz, 65 mW: 18 dBm (65 mW) conducted, less than or equal to 20 dBm (100 mW) EIRP
Power	<p><i>FlexPower</i> models: 10 to 30 V dc (Outside the USA: 12 to 24 V dc, $\pm 10\%$) on the brown wire, or 3.6 to 5.5 V dc low power option on the gray wire 6</p> <p>Integrated battery models: 3.6 V dc low power option from an internal battery or 10 to 30 V dc</p> <p>Master radio consumption (900 MHz): Maximum current draw is < 100 mA and typical current draw is < 30 mA at 24 V dc (2.4 GHz consumption is less)</p> <p>Repeater/slave radio consumption (900 MHz): Maximum current draw is < 40 mA and typical current draw is < 20 mA at 24 V dc (2.4 GHz consumption is less)</p>	
Compliance	900 MHz Compliance (1 Watt) FCC ID UE3RM1809: This device complies with FCC Part 15, Subpart C, 15.247 IC: 7044A-RM1809	2.4 GHz Compliance FCC ID UE300DX80-2400 - This device complies with FCC Part 15, Subpart C, 15.247 ETSI/EN: In accordance with EN 300 328: V1.8.1 (2012-04) IC: 7044A-DX8024
Spread Spectrum Technology	FHSS (Frequency Hopping Spread Spectrum)	
Antenna Connection	Ext. Reverse Polarity SMA, 50 Ohms	Max Tightening Torque: 0.45 N-m (4 lbf-in)
Interface	Indicators: Two bi-color LEDs	Buttons: Two Display: Six character LCD
Communication Hardware (MultiHop RS-485)	Interface: 2-wire half-duplex RS-485 Baud rates: 9.6k, 19.2k (default), or 38.4k via DIP switches; 1200 and 2400 via the MultiHop Configuration Tool Data format: 8 data bits, no parity, 1 stop bit	
Packet Size (MultiHop)	900 MHz: 175 bytes (85 Modbus registers)	2.4 GHz: 75 bytes (37 Modbus registers)
Intercharacter Timing (MultiHop)	3.5 milliseconds	
Housing	Polycarbonate housing and rotary dial cover; polyester labels; EDPM rubber cover gasket; nitrile rubber, non-sulphur cured button covers Weight: 0.26 kg (0.57 lbs) M-Hx and M-HxC models: Mounting: #10 or M5 (SS M5 hardware included) M-HxE models: Mounting: 1/4-in or M7 (SS M7 hardware included) Max. Tightening Torque: 0.56 N-m (5 lbf-in)	
Wiring Access	M-Hx models: Four PG-7, One 1/2-in NPT, One 5-pin threaded M12/Euro-style male quick-disconnect M-HxC models: External terminals M-HxE models: Two 1/2-in NPT ports	
Environmental Rating	M-Hx: IEC IP67; NEMA 6 "C" Housing Models: IEC IP20; NEMA 1 "E" Housing Models: IEC IP65; NEMA 4X	
Operating Conditions	M-Hx and M-HxC models: -40 °C to +85 °C (-40 °F to +185 °F) (Electronics); -20 °C to +80 °C (-4 °F to +176 °F) (LCD) M-HxE models: -40 °C to +65 °C (-40 °F to +149 °F) (Electronics); -20 °C to +80 °C (-4 °F to +176 °F) (LCD) 95% maximum relative humidity (non-condensing) Radiated Immunity: 10 V/m (EN 61000-4-3)	
Shock and Vibration	IEC 68-2-6 and IEC 68-2-27 Shock: 30g, 11 millisecond half sine wave, 18 shocks Vibration: 0.5 mm p-p, 10 to 60 Hz	
Certifications		

* See datasheet for model specific details

MultiHop Modbus-H6

The -H6 MultiHop Modbus Data Radio has a 1-wire serial interface that is designed to transmit data from 1-wire serial sensors, such as the Banner Temperature and Humidity (M12FTH4Q) and Vibration and Temperature (QM42VT1) sensors.

Key Features:

- 1-wire serial interface
- Battery-powered models for a completely wireless solution
- Tree topology allows for multiple hops to cover longer distances and circumvent obstacles



MultiHop Modbus Radios

Models	Power	I/O	Frequency
DX80DR9M-H6	D-cell Lithium battery	Inputs: 1-wire serial interface for one 1-wire serial sensing device	900 MHz
DX80DR2M-H6			2.4 GHz

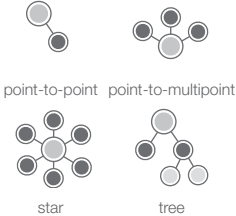

Used With

M12FTH4Q	see page 10	Temperature and relative humidity via a 1-wire serial interface
M12FT4Q	see page 10	Temperature via a 1-wire serial interface
QM42VT1	see page 8	Vibration and temperature via a 1-wire serial interface

MultiHop H6 Modbus Radio Specifications

Radio Range	900 MHz, 1 Watt: Up to 9.6 km (6 miles)	2.4 GHz, 65 mW: Up to 3.2 km (2 miles)
Minimum Separation Distance	900 MHz, 1 Watt: 4.57 m (15 ft)	2.4 GHz, 65 mW: 0.3 m (1 ft)
Radio Transmit Power	900 MHz, 1 Watt: 30 dBm (1 W) conducted (up to 36 dBm EIRP)	2.4 GHz, 65 mW: 18 dBm (65 mW) conducted, less than or equal to 20 dBm (100 mW) EIRP
Supply Voltage	3.6 V dc low power option from an internal battery	
Compliance	900 MHz Compliance (1 Watt) FCC ID UE3RM1809: This device complies with FCC Part 15, Subpart C, 15.247 IC: 7044A-RM1809	2.4 GHz Compliance FCC ID UE300DX80-2400 - This device complies with FCC Part 15, Subpart C, 15.247 ETSI/EN: In accordance with EN 300 328: V1.8.1 (2012-04) IC: 7044A-DX8024
Spread Spectrum Technology	FHSS (Frequency Hopping Spread Spectrum)	
Antenna Connection	Ext. Reverse Polarity SMA, 50 Ohms	Max Tightening Torque: 0.45 N-m (4 lbf-in)
Interface	Indicators: Two bi-color LEDs	Buttons: Two Display: Six character LCD
Communication Hardware (MultiHop RS-485)	Interface: 2-wire half-duplex RS-485 Baud rates: 9.6k, 19.2k (default), or 38.4k via DIP switches; 1200 and 2400 via the MultiHop Configuration Tool Data format: 8 data bits, no parity, 1 stop bit	
Packet Size (MultiHop)	900 MHz: 175 bytes (85 Modbus registers)	2.4 GHz: 75 bytes (37 Modbus registers)
Intercharacter Timing (MultiHop)	3.5 milliseconds	
Housing	Polycarbonate housing and rotary dial cover; polyester labels; EDPM rubber cover gasket; nitrile rubber, non-sulphur cured button covers Weight: 0.26 kg (0.57 lbs) Mounting: #10 or M5 (SS M5 hardware included) Max. Tightening Torque: 0.56 N-m (5 lbf-in)	
Wiring Access	One 5-pin threaded M12/Euro-style male quick-disconnect	
Environmental Rating	IEC IP67; NEMA 6	
Operating Conditions	-40 °C to +65 °C (-40 °F to +149 °F) (Electronics); -20 °C to +80 °C (-4 °F to +176 °F) (LCD) 95% maximum relative humidity (non-condensing) Radiated Immunity: 10 V/m (EN 61000-4-3)	
Shock and Vibration	IEC 68-2-6 and IEC 68-2-27 Shock: 30g, 11 millisecond half sine wave, 18 shocks Vibration: 0.5 mm p-p, 10 to 60 Hz	
Certifications		



Intrinsically Safe Nodes

Key Features:

- The DX99 is a state-of-the-art combination of wireless communication, battery technology and intrinsically safe electronics
- All models are certified for operation in Class I, Division 1 and ATEX Zone 0 locations
- Networks formed using DX80 Performance Gateways installed beyond the hazardous area and one or more Nodes operating in the same frequency band
- Both 900 MHz 150 mW and 2.4 GHz 63 mW models are available

DX99 FlexPower® Nodes — Class 1, Div 1 and Zone 0 (metal housing)

Models	I/O	Power Boost	Frequency
DX99N9X1S2N0M2X0D1	Discrete: Two inputs Analog: Two inputs (0-20 mA)	10 V	900 MHz
DX99N9X1S2N0M2X0D2		18 V	
DX99N9X1S2N0V2X0D1	Discrete: Two inputs Analog: Two inputs (0-10 V)	10 V	
DX99N9X1S2N0V2X0D2		18 V	
DX99N2X1S2N0M2X0D1	Discrete: Two inputs Analog: Two inputs (0-20 mA)	10 V	2.4 GHz
DX99N2X1S2N0M2X0D2		18 V	
DX99N2X1S2N0V2X0D1	Discrete: Two inputs Analog: Two inputs (0-10 V)	10 V	
DX99N2X1S2N0V2X0D2		18 V	
DX99N9X1S2N0T4X0D0	Thermocouple: Three inputs, one thermistor input Discrete: Two (NPN) inputs	n/a	900 MHz
DX99N2X1S2N0T4X0D0		n/a	2.4 GHz
DX99N9X1S0N0R4X0D0	RTD: Four inputs	n/a	900 MHz
DX99N2X1S0N0R4X0D0		n/a	2.4 GHz
DX99N9X1S2N0B2X0D0	Bridge: Two inputs Discrete: Two inputs	n/a	900 MHz
DX99N2X1S2N0B2X0D0		n/a	2.4 GHz
DX99N9X1S1S0V2X0D4	Inputs (Modbus Mode): One RS-485 Inputs (Voltage Mode): Two analog, one discrete	13 V	900 MHz
DX99N2X1S1S0V2X0D4			2.4 GHz
DX99N9X1S1N0M3X0D5	Inputs: One analog input with a 29 second warm-up time; one sinking discrete Additional Input Configurations: One 3-wire 100-Ohm Platinum RTD, one sinking discrete, and two analog (0-20 mA)	19 V	900 MHz
DX99N2X1S1N0M3X0D5			2.4 GHz



DX99 FlexPower Node Specifications

Radio Range	900 MHz, 150 mW: Up to 4.8 km (3 miles)	2.4 GHz, 65 mW: Up to 3.2 km (2 miles)
Minimum Separation Distance	900 MHz, 150 mW: 2 m (6 ft)	2.4 GHz, 65 mW: 0.3 m (1 ft)
Radio Transmit Power	900 MHz, 150 mW: 21 dBm (150 mW) conducted	2.4 GHz, 65 mW: 18 dBm (65 mW) conducted, less than or equal to 20 dBm (100 mW) EIRP
Compliance	900 MHz Compliance FCC ID TGUDX80 - This device complies with FCC Part 15, Subpart C, 15.247 IC: 7044A-DX8009	2.4 GHz Compliance FCC ID UE300DX80-2400 - This device complies with FCC Part 15, Subpart C, 15.247 ETSI/EN: In accordance with EN 300 328: V1.8.1 (2012-04) IC: 7044A-DX8024
Spread Spectrum Technology	FHSS (Frequency Hopping Spread Spectrum)	
RS-485 Inputs	Interface: 2-wire half-duplex RS-485 Baud Rates: 9.6k, 19.2k (default), or 38.4k Data Format: 8 data bits, no parity, 1 stop bit (even and odd parity selection are available)	
Communication Hardware (MultiHop RS-485)	Interface: 2-wire half-duplex RS-485 Baud rates: 9.6k, 19.2k (default), or 38.4k via DIP switches; 1200 and 2400 via the MultiHop Configuration Tool Data format: 8 data bits, no parity, 1 stop bit	
Link Timeout	Gateway: Configurable via User Configuration Tool (UCT) software Node: Defined by Gateway	
Supply Voltage	3.6 V dc low power option from an internal battery	
Power Consumption	Consumption: Application dependant	
Housing	Glass and cast aluminium with chromating and chemically-resistant paint (outside only)	
Antenna Connection	Ext. Reverse Polarity SMA, 50 Ohms Max Tightening Torque: 0.45 N-m (4 lbf-in)	
Interface	Indicators: Two bi-color LEDs Buttons: Two Display: Six character LCD	
Wiring Access	Two 1/2-in NPT ports, one 3/4-in NPT port (internal threads)	
Environmental Rating	IEC IP68	
Operating Conditions	-40 °C to +65 °C (-40 °F to +149 °F) (Electronics); -20 °C to +80 °C (-4 °F to +176 °F) (LCD) 95% maximum relative humidity (non-condensing) Radiated Immunity: 10 V/m (EN 61000-4-3)	
Shock and Vibration	IEC 68-2-6 and IEC 68-2-27 Shock: 30g, 11 millisecond half sine wave, 18 shocks Vibration: 0.5 mm p-p, 10 to 60 Hz	

Certifications



CSA: Class I, Division 1, Groups A, B, C, D; Class II, Division 1, Groups E, F, G; Class III, Division 1 (Ex ia IIC T4 / AEx ia IIC T4)
Certificate: 2008243



LCIE/ATEX: Zone 0 (Category 1G) and 20 (Category 1D), Temperature Class T4 (II 1 GD / Ex ia IIC T4/Ex iaD 20 IP68 T82°C)
Certificate: LCIE 08 ATEX 6098 X

Special Conditions for Safe Use imposed by Intrinsic Safety Certificate LCIE 08 ATEX 6098 X:

Ambient temperature range is -40 to 70 °C. Sure Cross® DX99 FlexPower devices can only be connected to Intrinsically Safe certified equipment or simple apparatus as defined by EN 60079-11. All connected equipment must comply with the Entity Parameters (Safety Parameters) listed in the Control Drawings (p/n 141513). The device must only use a lithium battery manufactured by XENO, type XL-205F.

K50 and K30 Hazardous Indicators



Banner's K50 and K30 Indicator Lights for hazardous areas have a smooth 50 or 30 mm diameter dome that provides uniform illumination from all directions.

- Up to three colors in one device and five colors to choose from
- Models rated to IP67 and IP69K for use in harsh environments
- Unique design appears gray when OFF, eliminating false indication from ambient light
- Easy mounting and configuration
- Worldwide IECEx approval for quicker access into countries outside Europe and North America

DXM100 Wireless Controller

The DXM100 Controller is an industrial wireless controller developed to facilitate Ethernet connectivity and Industrial Internet of Things (IIoT) applications. Available with an internal DX80 Gateway or a MultiHop Data Radio, this powerful Modbus communications device connects local wireless networks with the internet and/or host systems.

Key Features:

- ISM radios available in 900 MHz and 2.4 GHz for local wireless network
- Converts Modbus RTU to Modbus TCP/IP or Ethernet I/P
- Logic controller can be programmed using action rules and text language methods
- Micro SD card for data logging
- Email and text alerts
- Local I/O options: universal inputs, NMOS outputs, and analog outputs
- Powered by 12 to 30 V dc, 12 V dc solar panel, or battery backup
- RS-232, RS-485, and Ethernet communications ports; and a USB configuration port
- LCD display for I/O information and user programmable LED's

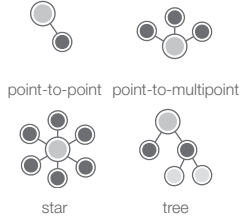

DXM Controllers

Models	Description	Frequency
DXM100-B1R1	DXM100 Controller preconfigured as a protocol converter	900 MHz
DXM100-B1R3	DXM100 Controller preconfigured as a protocol converter	2.4 GHz

DXM100 Controllers

Supply Voltage	12 to 30 V dc or 12 V dc solar panel and 12 V sealed lead acid battery	
Power Consumption	35 mA average at 12 V	
Solar Power Battery Charging	1 Amp maximum with 20 Watt solar panel	
Radio (ISM Band) Transmit Power	900 MHz at 1 Watt	2.4 GHz at 65 mW
Radio Range	900 MHz, 1 Watt: Up to 9.6 km (6 miles)	2.4 GHz, 65 mW: Up to 3.2 km (2 miles)
Minimum Separation Distance	900 MHz, 1 Watt: 4.57 m (15 ft)	2.4 GHz, 65 mW: 0.3 m (1 ft)
Antenna Connection	Ext. Reverse Polarity SMA, 50 Ohms Max Tightening Torque: 0.45 N-m (4 lbf-in)	
Radio Transmit Power	900 MHz, 1 Watt: 30 dBm (1 Watt) conducted (up to 36 dBm EIRP)	2.4 GHz, 65 mW: 18 dBm (65 mW) conducted, less than or equal to 20 dBm (100 mW EIRP)
Compliance	900 MHz Compliance (1 Watt) FCC ID UE3RM1809: This device complies with FCC Part 15, Subpart C, 15.247 IC: 7044A-RM1809	2.4 GHz Compliance FCC ID UE300DX80-2400 - This device complies with FCC Part 15, Subpart C, 15.247 ETSI/EN: In accordance with EN 300 328: V1.8.1 (2012-04) IC: 7044A-DX8024
Spread Spectrum Technology	FHSS (Frequency Hopping Spread Spectrum)	
Logging	8 GB maximum; removable Micro SD card format	
Protocols	Modbus RTU Master/Slave, Modbus TCP, and Ethernet/IP	
Construction	Polycarbonate; DIN rail mount option	
Communication Hardware (RS-322)	3-wire full duplex -15 to +15 Volts signaling Baud rates: 9.6k, 19.2k (default), or 38.4k Data format: 8 data bits, no parity, 1 stop bit	
Communication Hardware (RS-485)	3-wire half duplex RS-485 Baud rates: 9.6k, 19.2k (default), or 38.4k Data format: 8 data bits, odd, even or no parity, 1 stop bit	
Universal Inputs	Discrete NPN/PNP, 0 to 20 mA analog, 0 to 10 V analog, 10k thermistor, potentiometer sense	
Courtesy Power	One; output at 5 volts, 500 mA maximum	
Switched Power Outputs	Two; output at 5 to 16 Volts, 500 mA maximum	
Environmental Rating	IEC IP67; NEMA 6	
Operating Conditions	-40 °C to +85 °C (-40 °F to +185 °F) (Electronics); -20 °C to +80 °C (-4 °F to +176 °F) (LCD) 95% maximum relative humidity (non-condensing) Radiated Immunity: 10 V/m, 80-2700 MHz (EN 61000-4-3)	
Shock and Vibration	IEC 68-2-6 and IEC 68-2-27 Shock: 30g, 11 millisecond half sine wave, 18 shocks Vibration: .5 mm p-p, 10 to 60 Hz	
Analog Outputs	0 to 20 mA or 0 to 10 V dc output Accuracy: 0.1% of full scale +0.01% per °C Resolution: 12 bit	
NMOS Outputs	Less than 1 A max current at 30 V dc ON-state saturation: less than 0.7 V at 20 mA ON condition: Less than 0.7 V Off condition: Open	

Certifications



Additional Devices and Sensors

DX85 Modbus RTU Remote I/O Devices

These remote I/O devices have a Modbus interface and are used to expand the I/O of the Gateway or the Modbus host.



IP67 Housing



IP20 Housing

Models	I/O
DX85M6P6	DX85 Modbus RTU Remote I/O, 6 Discrete IN, 6 Discrete OUT
DX85M4P4M2M2	DX85 Modbus RTU Remote I/O, 4 Discrete IN, 4 Discrete OUT, 2 Analog IN, 2 Analog OUT (0 to 20 mA)
DX85M4P8	DX85 Modbus RTU Remote I/O, 4 Discrete IN, 8 Discrete OUT
DX85M8P4	DX85 Modbus RTU Remote I/O, 8 Discrete IN, 4 Discrete OUT
DX85M0P0M4M4	DX85 Modbus RTU Remote I/O, 4 Analog IN, 4 Analog OUT (0 to 20 mA)
DX85M-P7	DX85 Modbus RTU Remote I/O, Up to 12 sinking inputs or up to 12 NMOS sinking outputs (for a total of 12 I/O)
DX85M-P8	DX85 Modbus RTU Remote I/O, Up to 12 sourcing inputs or up to 12 sourcing outputs (for a total of 12 I/O)

NOTE: Add a "C" to the end of any DX85 model to order the I/O mix with an IP20 housing. The IP20 models are Class 1, Division 2 certified when installed in a suitable enclosure.

Sensors Optimized for Use with FlexPower® Devices

Models	I/O
SM312LPQD-78447	MINI-BEAM®, Low Power, 5 V, polarized retroreflective, 3 m
SM312DQD-78419	MINI-BEAM®, Low Power, 5 V, diffuse, 38 cm
QT50ULBQ6-75390	Ultrasonic, QT50U, 200 mm to 8 m range
QS30WEQ	WORLD-BEAM® Photoelectric Emitter, QS30 (Max Range: 100 ft, 10x excess gain at 50 ft), 1-wire serial interface
QS30WRQ	WORLD-BEAM® Photoelectric Receiver, QS30 (Max Range: 100 ft, 10x excess gain at 50 ft), 1-wire serial interface





GPS50M GPS Module

Low power consumption, ability to withstand harsh environments, flexible power supply requirements and Modbus RTU communications makes this module ideal for the industrial market.

- Self-contained GPS Module for industrial use.
- Flexible Power Requirements: 5 to 30 V dc with power consumption as low as 100 mW
- Positional error of less than 2.5 meters
- Self-contained for harsh environment; IP69K-rated

GPS50M GPS Module Specifications

Power Requirements	5 to 30 V dc	
Current	Maximum: < 0.5 W Power Save Mode ON Typ. Average: 4 mA at 24 V dc Power Save Mode OFF Tye. Average: 10 mA at 24 V dc	
Indicators	Green flashing: Power ON	Amber flashing: Modbus communication active
Indicators	Green flashing: Power ON	Red flicker: Serial Tx
Operating Temperature	-40 to +85 °C (-40 to +185 °F)	
GPS Features	<ul style="list-style-type: none"> • SiRF Star IV GPS chip • Satellite-based augmentation systems: WAAS, EGNOS, MSAS, GAGAN 	<ul style="list-style-type: none"> • High sensitivity navigation engine (PVT) tracks as low as -163 dBm • Update Rate: 1 Hz
Communication	<ul style="list-style-type: none"> • Interface: RS-485 serial • Baud rates: 9.6k, 19.2k (default), or 38.4k • Data format: 8 data bits, no parity (default), 1 stop bit (even or odd parity available) 	<ul style="list-style-type: none"> • Do not use termination resistor • Protocol: Modbus RTU
Shock and Vibration	<ul style="list-style-type: none"> • IEC 68-2-6 and IEC 68-2-27 • Shock: 30g, 11 millisecond half wave, 18 shocks • Vibration: 0.5 mm p-p, 10 to 60 Hz 	
Accuracy	<ul style="list-style-type: none"> • Positional error of less than 2.5 m (8') with augmentation • Positional error of less than 10 m (33') with no augmentation 	

Other Sensors or Sensor Components

Models	I/O
BWA-THERMISTOR-001	NTC Thermistor, 2.2 KOhms, +/-0.2%C, blue bead (For models: DX80N9X2S2N2T/C, DX99N9X2S2N0T4X0A0, and DX99N9X1S2N0T4X0D0)
BWA-THERMISTOR-002	NTC Thermistor, 10 KOhms, +/-0.2%C, black bead (For Performance models - P1/C/E, and MultiHop models M-H1/C/E), 2 pack
BWA-S612-30-100	NoShok Series 612 Submersible Level Transmitter, model 612-30-1-1-N-100, 0 to 30 psig, 100' cable
BWA-S612-15-100	NoShok Series 612 Submersible Level Transmitter, model 612-15-1-1-N-100, 0 to 15 psig, 100' cable
BWA-625-5000-1-1-8-25	NoShok Series 625 Intrinsically Safe Pressure Transmitter, model 625-5000-1-1-8-25, 0 to 5000 psig, 1/2-in NPT, 4-20mA, M12 QD
BWA-625-10000-1-1-8-25	NoShok Series 625 Intrinsically Safe Pressure Transmitter, model 625-10000-1-1-8-25, 0 to 10000 psig, 1/2-in NPT, 4-20mA, M12 QD
BWA-P-RKGV 5.33T-1727-2.0	Cable, female M12 4-pin, blue PVC, SS connector, for NoShok Series 625 IS Pressure Transmitter
BWA-ACC-SEN-SDI	Acclima SDI-12 Soil Moisture Transducer





Accessories

Accessories

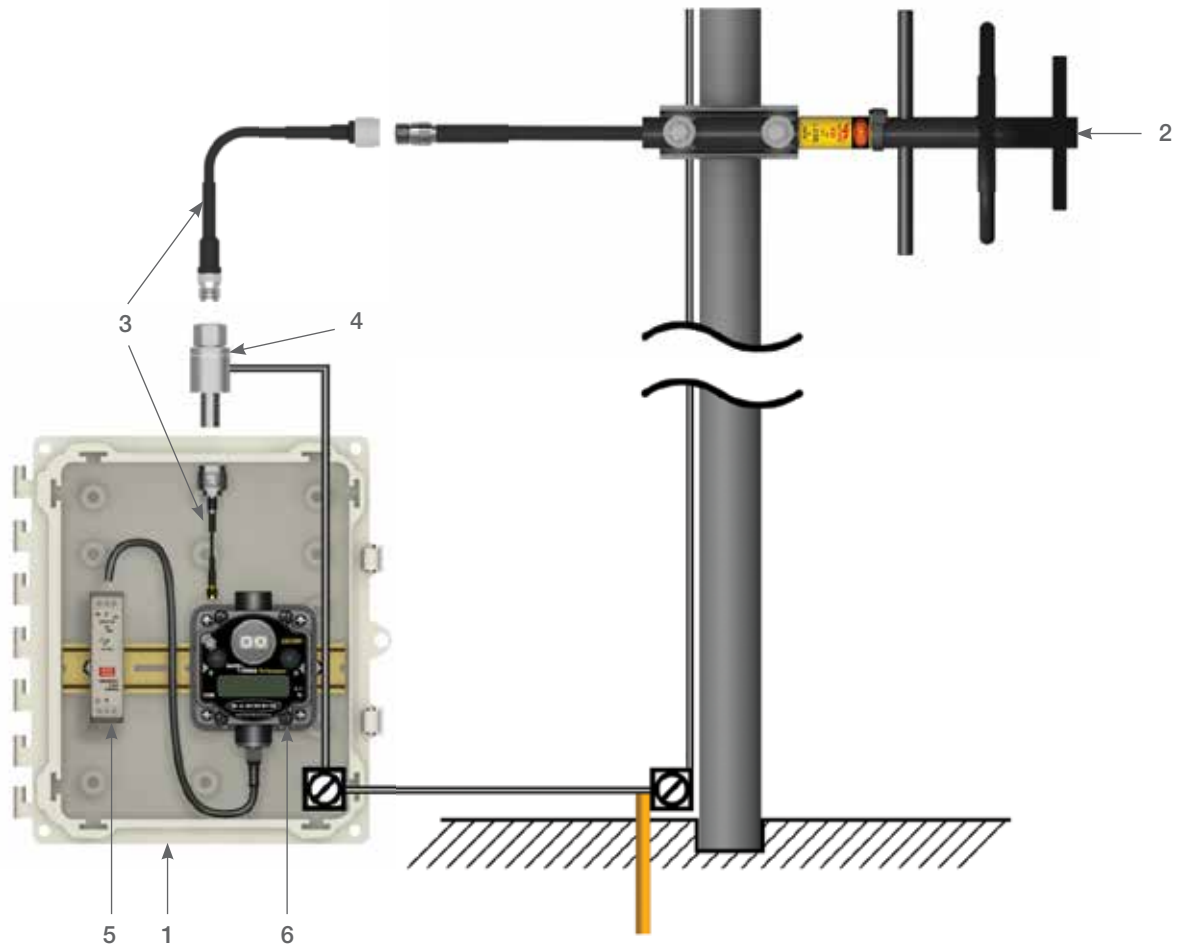

NOTE: The Sure Cross® Radio installation shown includes wireless accessories available from Banner. It is for illustration purposes only. Installations may vary.

(1) Enclosures	63
(2) Antennas	65
(3) Antenna Cables	66
(4) Surge Suppressors	67
(5) Power Supplies.....	67
(6) Brackets	69
Cables.....	70
Cordsets	71
Hardware and Replacement Parts	73
Replacement Filters	73
Cable Glands and Plugs	74
Metal Housing Accessories.....	74



6 × 6 in:
Fits a single DX80.



10 × 8 in:
Fits a power supply, surge suppressor, a single DX80, and a few relays. This is a popular size but can get cramped.



12 × 10 in:
This is the recommended size; provides ample room for multiple radios and accessories.

(1) Enclosures



Polycarbonate Enclosures

BWA-AH664	Enclosure, Polycarbonate, with Opaque Cover, 6 × 6 × 4 in
BWA-AH864	Enclosure, Polycarbonate, with Opaque Cover, 8 × 6 × 4 in
BWA-AH1084	Enclosure, Polycarbonate, with Opaque Cover, 10 × 8 × 4 in
BWA-AH12106	Enclosure, Polycarbonate, with Opaque Cover, 12 × 10 × 6 in
BWA-AH14126	Enclosure, Polycarbonate, with Opaque Cover, 14 × 12 × 6 in
BWA-AH16148	Enclosure, Polycarbonate, with Opaque Cover, 16 × 14 × 8 in
BWA-AH181610	Enclosure, Polycarbonate, with Opaque Cover, 18 × 16 × 10 in
BWA-AH664C	Enclosure, Polycarbonate, with Clear Cover, 6 × 6 × 4 in
BWA-AH864C	Enclosure, Polycarbonate, with Clear Cover, 8 × 6 × 4 in
BWA-AH1084C	Enclosure, Polycarbonate, with Clear Cover, 10 × 8 × 4 in
BWA-AH12106C	Enclosure, Polycarbonate, with Clear Cover, 12 × 10 × 6 in
BWA-AH14126C	Enclosure, Polycarbonate, with Clear Cover, 14 × 12 × 6 in
BWA-AH16148C	Enclosure, Polycarbonate, with Clear Cover, 16 × 14 × 8 in
BWA-AH181610C	Enclosure, Polycarbonate, with Clear Cover, 18 × 16 × 10 in

Swing Panel Kits

BWA-AH66SPK	Swing Panel Kit, 6 × 6 in, Includes Mounts, Screws, and Panel
BWA-AH86SPK	Swing Panel Kit, 8 × 6 in, Includes Mounts, Screws, and Panel
BWA-AH108SPK	Swing Panel Kit, 8 × 10 in, Includes Mounts, Screws, and Panel
BWA-AH1210SPK	Swing Panel Kit, 12 × 10 in, Includes Mounts, Screws, and Panel
BWA-AH1412SPK	Swing Panel Kit, 14 × 12 in, Includes Mounts, Screws, and Panel
BWA-AH1614SPK	Swing Panel Kit, 16 × 14 in, Includes Mounts, Screws, and Panel
BWA-AH1816SPK	Swing Panel Kit, 18 × 16 in, Includes Mounts, Screws, and Panel

Back Panel Kits

BWA-BP66A	Back Panel, aluminum, 6 × 6 in
BWA-BP86A	Back Panel, aluminum, 8 × 6 in
BWA-BP108A	Back Panel, aluminum, 8 × 10 in
BWA-BP1210A	Back Panel, aluminum, 12 × 10 in
BWA-BP1412A	Back Panel, aluminum, 14 × 12 in
BWA-BP1614A	Back Panel, aluminum, 16 × 14 in
BWA-BP1816A	Back Panel, aluminum, 18 × 16 in

(1) Enclosures, continued



Fiberglass Enclosures

BWA-EF14128	Enclosure Fiberglass Hinged 14 × 12 × 8 in
BWA-EF1086	Enclosure Fiberglass Hinged 10 × 8 × 6 in
BWA-EF866	Enclosure Fiberglass Hinged 8 × 6 × 6 in
BWA-PA1412	Panel, 14 × 12 in
BWA-PA108	Panel, 10 × 8 in
BWA-PA86	Panel, 8 × 6 in
BWA-PM12	Pole Mount, 12 in
BWA-PM8	Pole Mount, 8 in
BWA-PM6	Pole Mount, 6 in

Mounting Accessories

BWA-AHSNK	Slot Nut Kit, Includes 2 Nuts and 2 Screws
BWA-AHSPM	Swing Panel Mounts (4 per Kit)
BWA-AHLK	Latch Kit, 2 Latches per Kit, Replacement Only
BWA-AHAK	Accessory Kit, Includes all screws, inserts, and mounting feet (Replacement Only)
BWA-AHTBS	Screw 10-32 X .375 Phl Ph Zinc Self-threading

DIN Rail Kits

BWA-AH6DRK	DIN Rail Kit, 6 in, Includes 2 Nuts, 2 Screws, and DIN Rail
BWA-AH8DRK	DIN Rail Kit, 8 in, Includes 2 Nuts, 2 Screws, and DIN Rail
BWA-AH10DRK	DIN Rail Kit, 10 in, Includes 2 Nuts, 2 Screws, and DIN Rail
BWA-AH12DRK	DIN Rail Kit, 12 in, Includes 2 Nuts, 2 Screws, and DIN Rail
BWA-AH14DRK	DIN Rail Kit, 14 in, Includes 2 Nuts, 2 Screws, and DIN Rail
BWA-AH16DRK	DIN Rail Kit, 16 in, Includes 2 Nuts, 2 Screws, and DIN Rail
BWA-AH18DRK	DIN Rail Kit, 18 in, Includes 2 Nuts, 2 Screws, and DIN Rail

DIN Rail Kits

BWA-AH6DR	Din Rail Kit 6 in (Includes 2 Tribolar Screws and DIN Rail)
BWA-AH8DR	Din Rail Kit 8 in (Includes 2 Tribolar Screws and DIN Rail)
BWA-AH10DR	Din Rail Kit 10 in (Includes 2 Tribolar Screws and DIN Rail)
BWA-AH12DR	Din Rail Kit 12 in (Includes 2 Tribolar Screws and DIN Rail)
BWA-AH14DR	Din Rail Kit 14 in (Includes 2 Tribolar Screws and DIN Rail)
BWA-AH16DR	Din Rail Kit 16 in (Includes 2 Tribolar Screws and DIN Rail)
BWA-AH18DR	Din Rail Kit 18 in (Includes 2 Tribolar Screws and DIN Rail)

(2) Antennas



Omni-Directional Antennas with RP-SMA Male Connections

BWA-902-C	900 MHz	2 dBi, Rubber swivel (ships with 900 MHz radios)	
BWA-905-C		5 dBi, Rubber swivel	

BWA-202-C	2.4 GHz	2 dBi, Rubber swivel, 3 1/4 in (ships with 2.4 GHz radios)	
BWA-205-C		5 dBi, Rubber swivel, 6 1/2 in	
BWA-207-C		7 dBi, Rubber swivel, 9 1/4 in	

BWA-902-RA	900 MHz	2 dBi, Rubber fixed right-angle	
------------	---------	---------------------------------	--

BWA-201-001	2.4 GHz	1 dBi, Rubber, 1 inch tall	
-------------	---------	----------------------------	--

Omni-Directional Dome Antennas

BWA-902-D	900 MHz	2 dBi, 18 inch cable	RP-SMA Box Mount
-----------	---------	----------------------	------------------

BWA-202-D	2.4 GHz	2 dBi, 18 inch cable	RP-SMA Box Mount
-----------	---------	----------------------	------------------

Other

BWA-205-M	2.4 GHz	5 dBi, Magnetic whip antenna, 12 ft cable	RP-SMA Male
-----------	---------	---	-------------

(2) Antennas, continued



Omni-Directional Fiberglass Antennas with N-Type Female Connections

BWA-906-A	900 MHz	2 dBi, Rubber swivel (ships with 900 MHz radios)
BWA-208-A	2.4 GHz	8.5 dBi, Fiberglass, 24 in
BWA-206-A		6 dBi, Fiberglass, 16 in (shown)
BWA-906-AS	900 MHz	6 dBi, Fiberglass, 1/4 Wave, 23.6 in (1.3 inch diameter)
BWA-908-AS		8 dBi, Fiberglass, 3/4 Wave, 63 in (1.5 inch diameter)



Directional (Yagi) Antennas with N-Type Female Connection

BWA-9Y6-A	900 MHz	6.5 dBd, 6.8 × 13 inches Outdoor
BWA-9Y10-A	900 MHz	10 dBd, 6.8 × 24 inches Outdoor

(3) Antenna Cables



Antenna Cables: RP-SMA to RP-SMA

BWC-1MRSFRSB0.2	RG58, RP-SMA Male to RP-SMA Female Bulkhead, 0.2 m
BWC-1MRSFRSB1	RG58, RP-SMA Male to RP-SMA Female Bulkhead, 1 m
BWC-1MRSFRSB2	RG58, RP-SMA Male to RP-SMA Female Bulkhead, 2 m
BWC-1MRSFRSB4	RG58, RP-SMA Male to RP-SMA Female Bulkhead, 2 m
BWC-2MRSFRS3	LMR200, RP-SMA Male to RP-SMA Female, 3 m
BWC-2MRSFRS6	LMR200, RP-SMA Male to RP-SMA Female, 6 m
BWC-2MRSFRS9	LMR200, RP-SMA Male to RP-SMA Female, 9 m
BWC-2MRSFRS12	LMR200, RP-SMA Male to RP-SMA Female, 12 m



Antenna Cables: RP-SMA to N-Type

BWC-1MRSMN05	LMR100 RP-SMA to N-Type Male, 0.5 m
BWC-1MRSMN2	LMR100 RP-SMA to N-Type Male, 2 m



Antenna Cables: N-Type

BWC-4MNFN3	LMR400 N-Type Male to N-Type Female, 3 m
BWC-4MNFN6	LMR400 N-Type Male to N-Type Female, 6 m
BWC-4MNFN15	LMR400 N-Type Male to N-Type Female, 15 m
BWC-4MNFN30	LMR400 N-Type Male to N-Type Female, 30 m

(4) Surge Suppressors



BWC-LFNBMN-DC

Surge Suppressor, bulkhead, N-Type Female, N-Type Male, dc Blocking



BCW-LMRSFRPB

Surge Suppressor, bulkhead, RPSMA to RP-SMA

(5) Power Supplies

DC Power Supplies



PS24W

DC Power Supply, 500 mA, 24 V dc, Demo kit power supply



PSDINP-24-06

DC Power Supply, 0.63 Amps, 24 V dc, with DIN Rail Mount, Class I Division 2 (Groups A, B, C, D) Rated

PSDINP-24-13

DC Power Supply, 1.3 Amps, 24 V dc, with DIN Rail Mount, Class I Division 2 (Groups A, B, C, D) Rated

PSDINP-24-25

DC Power Supply, 2.5 Amps, 24 V dc, with DIN Rail Mount, Class I Division 2 (Groups A, B, C, D) Rated

FlexPower Supplies and Replacement Batteries



DX81-LITH

Battery Supply Module with mounting hardware

DX81H

Battery Supply Module with mounting hardware, for DX99 polycarbonate housing



DX81P6

Battery Supply Module, six "D" cells, with mounting hardware



BWA-BATT-001

Lithium "D" cell, single, for DX81-LITH and DX81H Battery Supply Module

BWA-BATT-006

Lithium "AA" cell, single, for Wireless Q45 Sensors for DX81x models

(5) Power Supplies, continued



Solar Panels

BWA-SOLAR PANEL 3W	Solar Panel, 12 V, 3 W, Multicrystalline, 188 × 195 × 15, Wall/Pole clamp style mounting bracket included
BWA-SOLAR PANEL 5W	Solar Panel, 12 V, 5 W, Multicrystalline, 270 × 222 × 17, Wall/Pole clamp style mounting bracket included
BWA-SOLAR PANEL 20W	Solar Panel, 12 V, 20 W, Multicrystalline, 573 × 357 × 30, "L" mounting bracket included
BWA-SOLAR CNTRL-12V	Solar Controller, 6 A Load Current 12 V System Voltage, recommended for 20 watts or less solar panel AND Sealed Lead Acid Battery (SLA)

Relays



IB6RP	Interface Relay Box, 18 to 26 V dc inputs, isolated relay outputs (not shown)
BWA-RELAY-12V	Relay, Blade Style with Base, 12 V
BWA-RELAY-24V	Relay, Blade Style with Base, 24 V
BWA-RH1B-UDC12V	Relay, Blade Style, No Base, 12 V (replacement part)
BWA-RH1B-UDC24V	Relay, Blade Style, No Base, 24 V (replacement part)
BWA-SH1B-05	Relay Base Only (replacement part)

(6) Brackets

Mounting Kit

BWA-HW-001

- Screw, M5-0.8 x 25 mm, SS (4)
- Screw, M5-0.8 x 16 mm, SS (4)
- Hex nut, M5-0.8 mm, SS (4)
- Bolt, #8-32 x 3/4-in, SS (4)

Brackets



SMBDX80DIN

- Black reinforced thermoplastic bracket for mounting on a 35 mm DIN rail



BWA-HW-034

- DIN rail clip, black plastic
- Used with the M-HBx MultiHop and -PBx Performance board modules



Hole center spacing: A = 26.0, A to B = 13.0
 Hole size: A = 26.8 x 7.0, B = \varnothing 6.5, C = \varnothing 19.0

SMBAMS18RA

- Right-angle SMBAMS series bracket with 18 mm hole
- Articulation slots for 90+° rotation
- 12-ga. (2.6 mm) cold-rolled steel



Hole center spacing: 35.1
 Hole size: 25.4 x 5.3

DIN-35-70 = 70 mm
DIN-35-105 = 105 mm
DIN-35-140 = 140 mm

- 35 mm DIN Rail

Cables

Ethernet Cables

Use a crossover cable to connect the GatewayPro or DX83 Ethernet Bridge to a host system without using an Ethernet switchbox or hub. When using a switchbox or hub, use a straight cable.

BWA-E2M	Ethernet cable, RSCD RJ45 440, 2 m
BWA-E8M	Ethernet cable, RSCD RJ45 440, 8 m
BWA-EX2M	Ethernet cable, crossover, RSCD RJ45CR 440, 2 m



Adaptor Cables

BWA-HW-006	Adaptor cable, USB to RS-485, for use with the User Configuration Tool software (UCT)
BWA-UCT-900 (shown)	Adaptor cable with power, USB to RS-485, for use with the User Configuration Tool software (UCT), supplies power to 1 Watt radios

Splitter Cables

Use **CSRB-M1250M125.47M125.73** to split power between two *FlexPower*® or solar powered devices. DO NOT use this cable to connect a *FlexPower* devices to a 10 to 30 V dc powered device.

Use **CSRB-M1253.28M1253.28M1253.28** to connect one *FlexPower* device (data radio, FlexPowered Gateway, etc) to two power sources, such as the *FlexPower* Solar Supply and DX81P6 Battery Pack.

Model	Length	Style	Pinout
CSRB-M1250M125.47M125.73	Trunk: 0 m (male) Branches: 0.14 m and 0.22 m (female)	Straight	<p>1 = Brown 2 = White 3 = Blue 4 = Black 5 = Green/Yellow</p>
CSRB-M1253.28M1253.28M1253.28	Trunk: 1 m (female) Branches: 1 m (male)		

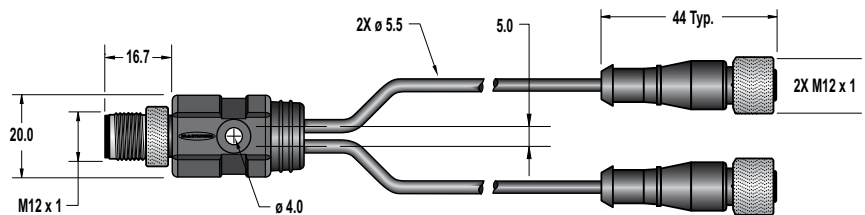

Cordsets

Euro-Style — Single-Ended

Right-angle cordsets are not compatible with the DX70 devices. When facing the Node or Gateway toward you and the quick-disconnect connection is facing down, the right-angle cables exit to the right.

When using the *FlexPower*® Node with integrated battery, use a double-ended cordset. When using a *FlexPower* Node with external power supply, use a single-ended cordset. If using the communication lines, the cable length cannot exceed 3 meters (10 ft).

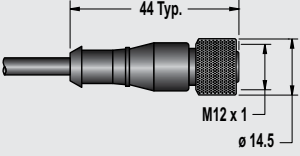
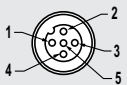
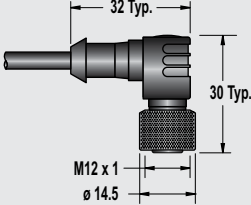
Model	Length	Style	Dimensions	Pinout
MQDC1-501.5	0.50 m (1.5 ft)	Straight		<p>Female</p>  <p>1 = Brown 2 = White 3 = Blue 4 = Black 5 = Gray</p>
MQDC1-506	1.83 m (6 ft)			
MQDC1-515	4.57 m (15 ft)			
MQDC1-530	9.14 m (30 ft)			
MQDC1-506RA	1.83 m (6 ft)	Right-Angle		
MQDC1-515RA	4.57 m (15 ft)			
MQDC1-530RA	9.14 m (30 ft)			

Model	Length	Style	Description
BWA-QD5.5	—	—	Prewired 5-pin Euro connector, 1/2-14 NBSM
BWA-QD8.5	—	—	Prewired, 8-pin Euro connector, 1/2-14 NBSM
BWA-QD12.5	—	—	Prewired 12-pin Euro connector, 1/2-14 NBSM
FIC-M12F4	—	Straight	Euro-Style Field-Wireable Connector 4-pin Female Straight
DEUR-506.6C	1.83 m	Straight	Cordset, 5-pin Euro-style, double ended, male/female
MQDMC-401	0.5 m	Straight	Cordset, 4-pin Euro-style, single ended, male, longer pigtails for DX80...C models

Cordsets, continued

Euro-Style — Double-Ended

When using the *FlexPower*® Node with integrated battery, use a double-ended cordset. When using a *FlexPower* Node with external power supply, use a single-ended cordset. If using the communication lines, the cable length cannot exceed 3 meters (10 feet).

Model	Length	Style	Dimensions	Pinout
DEE2R-51D	0.31 m (1 ft)	Female Straight/ Male Straight		<p>1 = Brown 2 = White 3 = Blue 4 = Black 5 = Green/Yellow</p>
DEE2R-53D	0.91 m (3 ft)			
DEE2R-58D	2.44 m (8 ft)			

Other Cordsets

BWA-RIBBON-001	Ribbon cable, 20-pin DBL socke
BWA-HW-010	Cable, <i>FlexPower</i> Current Monitoring

Hardware and Replacement Parts

Model	Description
BWA-HW-002	DX80 Access Hardware Kit: Plastic threaded plugs, PG-7 (4) Nylon gland fittings, PG-7 (4) Hex nuts, PG-7 (4) Plug, 1/2-in NPT Nylon gland fitting, 1/2-in NPT
BWA-HW-003	PTFE Tape, 1/4-in wide, 600-in long
BWA-HW-004	Replacement Seals: O-ring, rotary access cover, PG21 (2) O-ring, body gasket (2) Access cover, rotary dials, clear plastic (2)
BWA-HW-009	Solar assembly hardware pack, includes brackets, bolts, and set screws
BWA-HW-007	Housing Kit, DX80, top and bottom, 10 pieces
BWA-HW-008	Housing Kit, DX81, top and bottom, 10 pieces
BWA-HW-044	Terminal header for the MultiHop Ethernet Data Radio
BWA-HW-011	Terminal Block Headers, IP20, 2 pack
BWA-HW-012	DX99 Antenna Extension Pack: Screw, M4-0.7 x 20, pan head, black steel Flexible Antenna Cable, 12 in, SMA male to SMA female
BWA-HW-032	Access hardware for the E housing, one 1/2-in plug, one 1/2-in gland
BWA-HW-037	Clear plastic retaining ring for DX99 metal housings, 10 pack

Replacement Filters



Model	Description
FTH-FIL-001	Aluminum grill filter cap (factory default, ships with M12FT*Q sensors)
FTH-FIL-002	Stainless steel, sintered to 10 micrometer porosity (for high dust environments)

Cable Glands and Plugs

Model	Description
BWA-HP.5-10	Dummy Hole Plugs, 1/2-in NPT, 10 pieces
BWA-HW-031	Vent Plug, 1/2-in NPT, IP67
BWA-CG.5-10	Cable Glands, 1/2-in NPT, Cordgrip for 3 holes of 2.8 to 5.6 mm diameter, 10 Pack
BWA-CG.5-3X5.6-10	Solar assembly hardware pack, includes brackets, bolts, and set screws
BWA-CG.5-2X2.5-10	Cable Glands, 1/2-in NPT, Cordgrip for 2 holes of 1.2 to 2.5 mm diameter, 10 Pack
BWA-CG.5-6X4.0-10	Cable Glands, 1/2-in NPT, Cordgrip for 6 holes of 2 to 4 mm diameter, 10 Pack
BWA-CG.5-6X3.0-10	Cable Glands, 1/2-in NPT, Cordgrip for 6 holes of 1.5 to 3 mm diameter, 10 Pack

Metal Housing Accessories



Model	Description
BWA-HW-016	Antenna Feedthrough, Stainless Steel, 1/2-in NPT
BWA-HW-017	Antenna Feedthrough, Stainless Steel, 3/4-in NPT
BWA-HW-012	DX99 Antenna Extension Pack (M4-0.7 × 20 black steel pan head screw, flexible antenna cable 12-in SMA male to SMA female)
BWA-HW-037	Clear plastic retaining ring for DX99 metal housings (10 pack)
BWA-AXFS0130	AXF™ Explosion-Proof Antenna Coupler

Omni-Directional Dome Antennas



Models	Frequency	Description	Connection
BWA-902-001	900 MHz	2 dBi, 18 inch cable	1/2-in SS NPT Port
BWA-902-002			3/4-in SS NPT Port
BWA-202-001	2.4 GHz		1/2-in SS NPT Port
BWA-202-002			3/4-in SS NPT Port



Reference



Data Security

Binding the radios in a network (similar to pairing a phone to a headset, but more secure) locks them to a specific master radio by teaching them the master radio's access code. After the devices are bound, the radios only accept data from that master radio and the master radio only accepts data from the radios that are bound to it.

The proprietary protocol used in Banner's wireless networks provides a high level of data security.

A pseudo-random frequency hopping table is used to provide noise immunity and data security. Each time a message is sent a new frequency is chosen, which makes it almost impossible for any system listening at a given time to hear more than a few messages out of hundreds.

Generic data transfer without context also keeps data secure. Even if a hacker managed to crack the data packet format, all they would see is a set of 16-bit numbers with no reference as to what the numbers mean.



Deterministic System

Determinism is the ability to predict and control network behavior by establishing default states for specific conditions. Banner's deterministic system defines how network endpoints behave during the loss of communications. The network identifies when the communications link is lost and sets relevant outputs to user defined conditions. Once the radio signal is reestablished, the network returns to normal operations.

Example: If a tank level sensor is being used to turn a pump on to refill the tank, the deterministic system will allow you to set the default output state as "OFF" if the wireless signal is lost. With the output set at "OFF", the pump will not be able to over fill the tank in the event of a loss of communications.



Frequency

Banner's wireless products operate in the license free ISM band with products that operate at the 900 MHz and 2.4 GHz frequencies.

- 2.4 GHz radios transmit data packets faster and require less power. They are primarily used outside North America.
- 900 MHz radios have a longer range and a better ability to penetrate walls and other obstacles. It is typically used in North America.



Frequency Hopping Spread Spectrum (FHSS)

Frequency Hopping Spread Spectrum is a radio communication technology where the frequency spectrum is divided into channels. Data packets are split up and transmitted on these channels in a random pattern known only to the transmitter and receiver (e.g., Gateway and Node). Because colocated networks follow different random patterns, or hop code tables, multiple networks can operate in close proximity without interfering. If interference is present on one channel, data transmission is blocked. The transmitter and receiver hop to the next channel in the hop table and the transmitter resends the data packet.

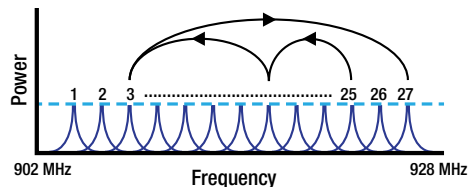

Intrinsically Safe

The Sure Cross® DX99 product line is classified as intrinsically safe (IS), not explosion proof, and is certified for a variety of hazardous locations. Intrinsically safe products limit electrical and thermal energy to levels below that required to ignite a flammable or combustible atmospheric mixture in hazardous areas. Each product's datasheet lists the specific certifications for that product.



Network Interference

The Banner wireless system can be installed within any existing 802.11b (Wi-Fi) environment. The low data rates and narrow frequency band of the Banner wireless system make it essentially silent to existing Wi-Fi networks. Additionally, Banner's Gateways and Nodes exchange a binding code that prevents radios outside the network from communicating with it. Finally, they also use multiple frequency hops to eliminate data collisions.



Network Security

The Banner wireless systems use a proprietary protocol and are designed to completely eliminate all Internet Protocol (IP) based security threats. Open protocols, such as Wi-Fi, can route malicious TCP/IP packets that can cause security breaches; however, the Banner wireless systems can not. The Banner protocol only carries sensor data values. It is not possible to gain access to the organization's main network through the Sure Cross wireless system and it is not possible to receive a web page or executable file over the wireless communication layer. Only I/O data is transmitted in the Banner wireless network.

Network Topologies



Point-to-Point

The most basic form of a radio network is called point-to-point. As the name implies, there are only two radios in this network, one Gateway and one Node.



Point-to-Multipoint

Point-to-multipoint is a relatively simple network with one Gateway and a few Nodes. Banner's PM Series is preconfigured to handle up to six Nodes.



Star

This network is formed by connecting multiple Nodes to a single Gateway. The Gateway maintains a communications connection with each Node on a separate communications path. If the communication between one of the Nodes and the gateway fails, the rest of the network remains unaffected.



Tree

This network involves several slaves that transmit information to repeaters, which ultimately transmit to the master radio. The use of repeaters can greatly extend the range of the network. This network must have a host controller that controls the master radio.



Network Scalability

Banner's Simple Wire Replacement products come preconfigured to handle up to 6 Nodes (PM8) so that it is easy to set up your network without software. The DX80 Performance Series offers Gateways that support multiple host communication protocols and up to 47 Nodes. Data Radios can handle up to 50 slave radios, and MultiHop Radios can handle up to 100 slave radios.

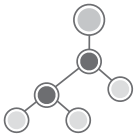

MultiHop

A MultiHop network uses repeaters to extend the range of the network with multiple “hops” to cover longer distances or to circumvent obstacles (trees, buildings, topology, etc.). MultiHop networks are also self-forming (all radios added to the network will automatically connect to the master or a repeater within its range) and self-healing (if a repeater is removed from the network, the radios connected to it can find a new path back to the master radio).

At the root of the MultiHop network is the master radio. All radios within range of the master (whether slave or repeater) connect to it. The master serves as the parent (controls the timing of the network), repeaters and slaves connect as children.

MultiHop Master Radio: Within a MultiHop network, there is only one master radio. It controls the overall timing of the network and is always the parent device. The master radio must be controlled by a host system.

MultiHop Repeater Radio: The repeater acts as a child to the master radio and a parent a slave radio. It retransmits data packets between the master radio and slave radios.

MultiHop Slave Radio: The slave radio is the end device of the network. A radio in slave mode does not retransmit data packets on the radio link.

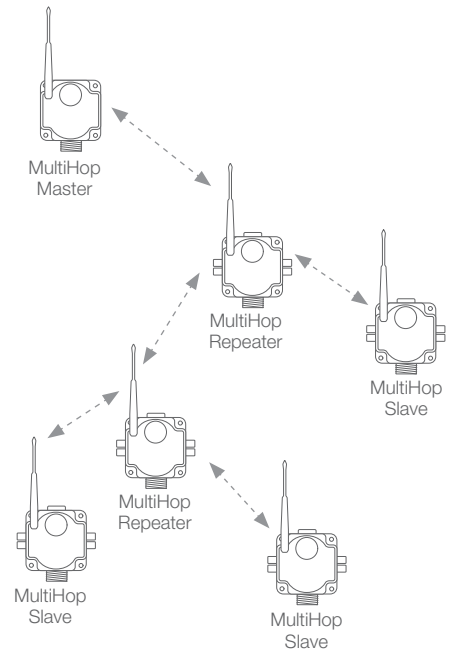

Radio Range

Banner’s wireless network is designed for long distance applications. The signal for 900 MHz, 1 Watt radios will travel up to 6 miles and 2.4 GHz, 65 mW radios will travel up to 2 miles line-of-sight.

Line-of-sight is the unobstructed path between radio antennas; however, signals can penetrate walls, floors and other indoor obstructions. Buildings, trees and large metal objects will impact signal strength in outdoor applications.

To verify range, Banner integrates a site survey tool into each Gateway and Node that displays real time signal quality results. Always conduct a site survey prior to installing a wireless network.

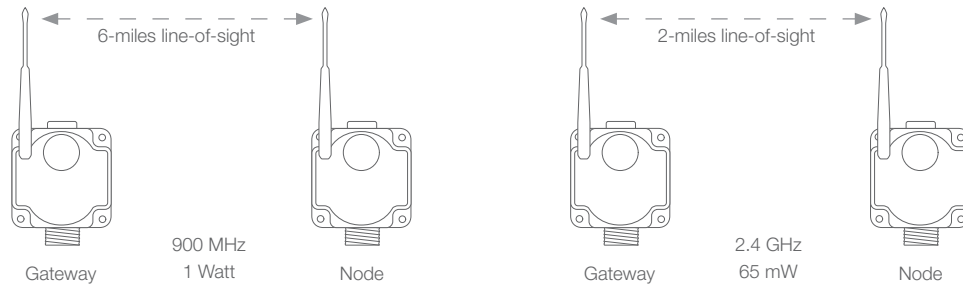

TDMA

Time Division Multiple Access (TDMA)

TDMA provides a specific communication time slot for each device in the network, eliminating data collisions. The master radio “requests” data from each node during its time slot, and the node then sends the data. A TDMA architecture also lends itself to efficient power management procedures. When each device knows the time period to receive or send, the radio doesn’t have to ‘listen’ all the time. Power usage can be managed efficiently, allowing radio devices to operate from 3.6 V lithium batteries when necessary.



More Information Online

www.bannerengineering.com

For the latest products, brackets, cordsets, accessories, and new solutions, find us on the web at www.bannerengineering.com.

You also have access to more detailed information such as engineering drawings, complete specifications, installation instructions, product configurators and product videos.



www.facebook.com/BannerEngineering



www.youtube.com/bannerengineering



@BannerSensors



www.linkedin.com/company/banner-engineering

How to Reach Us

Global Sales and Support

Questions? Need additional assistance?

Banner has more than 3,000 representatives and distributors worldwide — ready to help you.

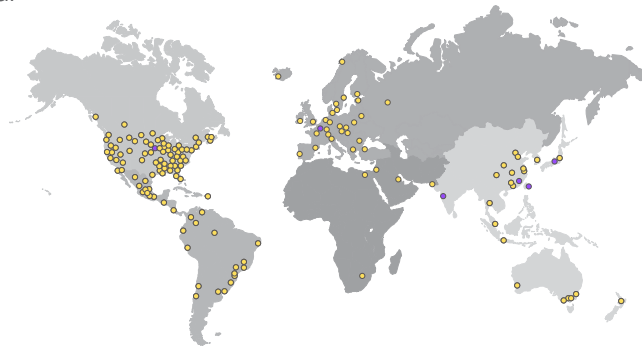

Our highly skilled application engineers and industry experts are ready to support you wherever you are. For a complete listing, go to bannerengineering.com and find your local Banner Representative.

To contact a Banner Engineer about your application, call

Technical Service
1-888-3-SENSOR

1-888-3SENSOR (1-888-373-6767)

Contact Us Online

www.bannerengineering.com/contact-us

Banner Engineering— Headquarters

Phone: +1 763 544 3164
www.bannerengineering.com

Banner Engineering— Europe

Phone: +32 2 456 07 80
www.bannerengineering.com/eu

Banner Engineering— Mexico

Phone: +52 81 8363-2714
www.bannerengineering.com.mx

Banner Engineering— China

Phone: +86 21 33986888
www.bannerengineering.com.cn

Banner Engineering— India

Phone: +91 20 66405623
www.bannerengineering.co.in

Limited Warranty

Banner Engineering Corp. warrants its products to be free from defects in material and workmanship for one year following the date of shipment. Banner Engineering Corp. will repair or replace, free of charge, any product of its manufacture which, at the time it is returned to the factory, is found to have been defective during the warranty period. This warranty does not cover damage or liability for misuse, abuse, or the improper application or installation of the Banner product.

THIS LIMITED WARRANTY IS EXCLUSIVE AND IN LIEU OF ALL OTHER WARRANTIES WHETHER EXPRESS OR IMPLIED (INCLUDING, WITHOUT LIMITATION, ANY WARRANTY OF MERCHANTABILITY OR FITNESS FOR A PARTICULAR PURPOSE), AND WHETHER ARISING UNDER COURSE OF PERFORMANCE, COURSE OF DEALING OR TRADE USAGE.

This Warranty is exclusive and limited to repair or, at the discretion of Banner Engineering Corp., replacement. **IN NO EVENT SHALL BANNER ENGINEERING CORP. BE LIABLE TO BUYER OR ANY OTHER PERSON OR ENTITY FOR ANY EXTRA COSTS, EXPENSES, LOSSES, LOSS OF PROFITS, OR ANY INCIDENTAL, CONSEQUENTIAL OR SPECIAL DAMAGES RESULTING FROM ANY PRODUCT DEFECT OR FROM THE USE OR INABILITY TO USE THE PRODUCT, WHETHER ARISING IN CONTRACT OR WARRANTY, STATUTE, TORT, STRICT LIABILITY, NEGLIGENCE, OR OTHERWISE.**



Banner Engineering Corp. reserves the right to change, modify or improve the design of the product without assuming any obligations or liabilities relating to any product previously manufactured by Banner Engineering Corp.



Banner Engineering Corp.

9714 Tenth Avenue North • Minneapolis, Minnesota 55441

763-544-3164 • 1-888-373-6767

www.bannerengineering.com

PN 158666

© 2016 Banner Engineering Corp. Mpls, MN USA