

# WORLD-BEAM® QS18AFF200 Sensors with Foreground Suppression

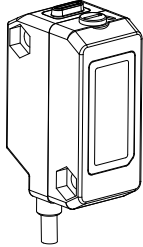

## Datasheet

Compact sensors featuring extended range and foreground suppression mode



- Exceptional optical performance; up to 200 mm sensing range in compact QS18 housing
- Foreground suppression models for reliable detection when a fixed background is present and the object color or shape varies
- Objects detected to the face of the sensor (no dead zone)
- Simple multi-turn screw adjustment of cutoff distance
- Enhanced immunity to fluorescent lights
- Crosstalk immunity algorithm allows two sensors to be used in close proximity
- Visible red emitter



**WARNING: Not To Be Used for Personnel Protection**

Never use this device as a sensing device for personnel **protection**. Doing so could lead to serious injury or death. This device does not include the self-checking redundant circuitry necessary to allow its use in personnel safety applications. A sensor failure or malfunction can cause either an energized or de-energized sensor output condition.

## Models

Long Range Models			
Models <sup>1</sup>	Supply Voltage	Sensing Range	Output Type
QS18VN6AFF200	10 to 30 V dc	Adjustable Cutoff: 30 to 200 mm	NPN
QS18VP6AFF200			PNP
QS18AB6AFF200			Bipolar (1 NPN & 1 PNP)

## Overview

WORLD-BEAM® QS18 Adjustable-Field Sensors with Foreground Suppression detect the light reflected from the background. The output changes when the light from the background is blocked.

In general, if the background is fixed and the color or shape of the objects in the foreground vary, foreground suppression mode will provide reliable detection. A foreground suppression sensor uses the background in the same way a retroreflective sensor would use a reflector. The sensor output will change whenever an object passes between itself and the background.

<sup>1</sup> Only standard 2 m (6.5 ft) cable models are listed.

- For 9 m (30 ft) cables: add suffix "W/30" to the model number (for example, QS18VN6AFF200 W/30).
- For 150 mm (6 in) pigtail with a 4-pin Pico-style connector, add suffix "Q" to the model number (for example, QS18VN6AFF200Q)
- For 150 mm (6 in) pigtail with a 4-pin Euro-style connector, add suffix "Q5" to the model number (for example, QS18VN6AFF200Q5)



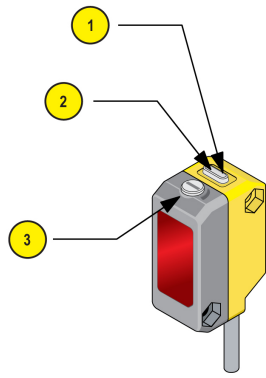

1	Green: Power Indicator
2	Yellow: Light Sensed Indicator (Flashes for Marginal Conditions)
3	Cutoff Point Adjustment Screw

Figure 1. Sensor features

### Sensor Orientation

To ensure reliable detection, orient the sensor as shown in relation to the target to be detected.

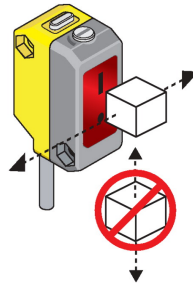
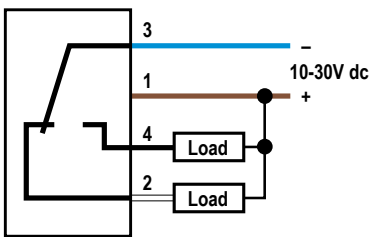

Figure 2. Optimal Orientation of Target to Sensor

### Wiring Diagrams

Cabled wiring diagrams are shown. Quick disconnect (QD) wiring diagrams are functionally identical.

NPN (Sinking) Outputs



PNP (Sourcing) Outputs

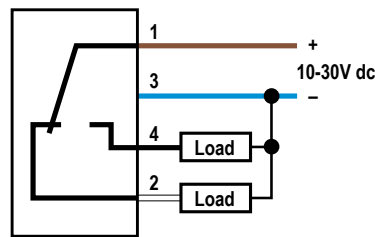

Wiring Key

- 1 = Brown
- 2 = White
- 3 = Blue
- 4 = Black

Bipolar Outputs

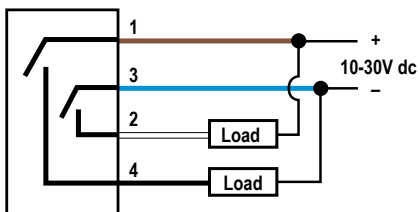

## Sensor Setup - Foreground Suppression

Foreground Suppression Mode (also called Background **Detection**): The light reflected off the background is detected. The output changes when the light from the background is blocked.

In general, if the background is fixed and the color or shape of the objects in the foreground vary, foreground suppression mode will provide reliable detection. A foreground suppression sensor uses the background in the same way a retroreflective sensor would use a reflector. The sensor output will change whenever an object passes between itself and the background.

To ensure reliable foreground suppression, a minimum separation distance between the object and the background is necessary. See [Figure 6](#) on page 6 to determine the minimum separation distance.

1. Mount the sensor within 200 mm of the fixed background.
2. Turn the adjustment potentiometer clockwise until it clicks (5 turns).
3. Turn the adjustment potentiometer counter-clockwise until the yellow indicator turns on. This places the cutoff distance in front of the fixed background (see [Figure 3](#) on page 3).
4. Place the application's darkest object into the sensor's field of view at the maximum sensor to the object distance, and verify that the yellow indicator turns **off**. The sensor is optimized for detecting thin objects close to the fixed background and is ready for operation.

For maximum sensing reliability in applications with variations in background position or color (for example, conveyor belts with flutter), follow these additional steps.

5. Continuing from step 4, turn the adjustment potentiometer counter-clockwise, counting the revolutions, until the yellow indicator turns on.
6. Turn the adjustment potentiometer clockwise half the number of revolutions from step 5. This places the cutoff distance midway between the object and the background. The sensor is optimized for reliable detection in applications with thick objects and modest variation in background. The sensor is ready for operation.

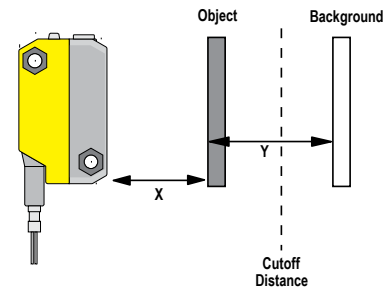

X: Distance to Background

Y: Minimum Separation Between Object and Background

*Figure 3. Set the cutoff distance in front of the fixed background*

## Setup Example

The sensor is positioned above a black conveyor belt at a distance of 150 mm. The objects on the conveyor are boxes of varying colors. According to [Figure 6](#) on page 6, the box height must be greater than 10 mm for reliable detection against a black background. In this application, reliable detection will be achieved when set up according to the procedure outlined in [Sensor Setup - Foreground Suppression](#) on page 3.

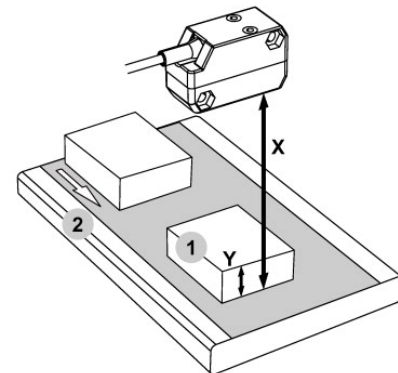

*Figure 4. Foreground Suppression Mode application example*

1. Object

2. Background (Conveyor)

X: Distance to Background = 150 mm

Y: Minimum Separation Between Object and Background > 10 mm

## Output States

Foreground Suppression Mode			
Sensor Model Type	Output	Object Between Sensor Face and Cutoff Distance	No Object Between Sensor Face and Fixed Background
All Models	Yellow Indicator Light	OFF	ON
Complementary Models	Black Wire (Pin 4)	OFF	ON
	White Wire (Pin 2)	ON	OFF
Bipolar Models	Black Wire (Pin 4)	OFF	ON
	White Wire (Pin 2)	OFF	ON

## Specifications

### Supply Voltage

10 to 30 V dc (10% maximum ripple within specified limits) at less than 16 mA, exclusive of load

### Sensing Beam

Visible red LED, 640 nm

### Supply Protection Circuitry

Protected against reverse polarity and transient voltages

### Output Configuration

Solid-state complementary: NPN or PNP (current sinking or sourcing), or bipolar (both sinking and sourcing) depending on model;  
**Rating:** 100 mA total output current

**Off-state** leakage current: < 50 µA at 30 V dc

**ON-state saturation** voltage: < 1.5 V at 10 mA; < 3.0 V at 100 mA

Protected against false pulse on power-up and continuous overload or short circuit of outputs

### Required Overcurrent Protection



**WARNING:** Electrical connections must be made by qualified personnel in accordance with local and national electrical codes and regulations.

Overcurrent protection is required to be provided by end product application per the supplied table.

Overcurrent protection may be provided with external fusing or via Current Limiting, Class 2 Power Supply.

Supply wiring leads < 24 AWG shall not be spliced.

For additional product support, go to [www.bannerengineering.com](http://www.bannerengineering.com).

Supply Wiring (AWG)	Required Overcurrent Protection (Amps)
20	5.0
22	3.0
24	2.0
26	1.0
28	0.8
30	0.5

### Output Response

2.8 millisecond ON/OFF

Note: 200 millisecond delay on power-up; outputs do not conduct during this time

### Adjustments

Five-turn adjustment screw sets cutoff distance between min. and max. positions, clutched at both ends of travel

### Repeatability

250 µs

### Indicators

2 LED indicators on sensor top:

Green solid: Power on

Amber solid: Light sensed

Amber flashing: Marginal sensing condition

### Construction

ABS housing, acrylic lens cover; PVC cable, nickel-plated brass connector, acetal adjustment pot

### Environmental Rating

IEC IP67; NEMA 6; UL Type 1

### Connections

2 m (6.5 ft) 4-wire PVC cable, 9 m (30 ft) PVC cable, or 4-pin Pico-style or Euro-style 150 mm (6 in) pigtail QD, depending on model

### Operating Conditions

Relative Humidity: 95% relative humidity at 50 °C (non-condensing)

Temperature: -20 °C to 55 °C (-4 °F to 131 °F)

### Application Notes

For mirror-like objects, minimize the sensor to object mounting distance and tilt the sensor so reflected light is directed away from the sensor when the object is present.

### Certifications



## Dimensions

All measurements are listed in millimeters [inches], unless noted otherwise.

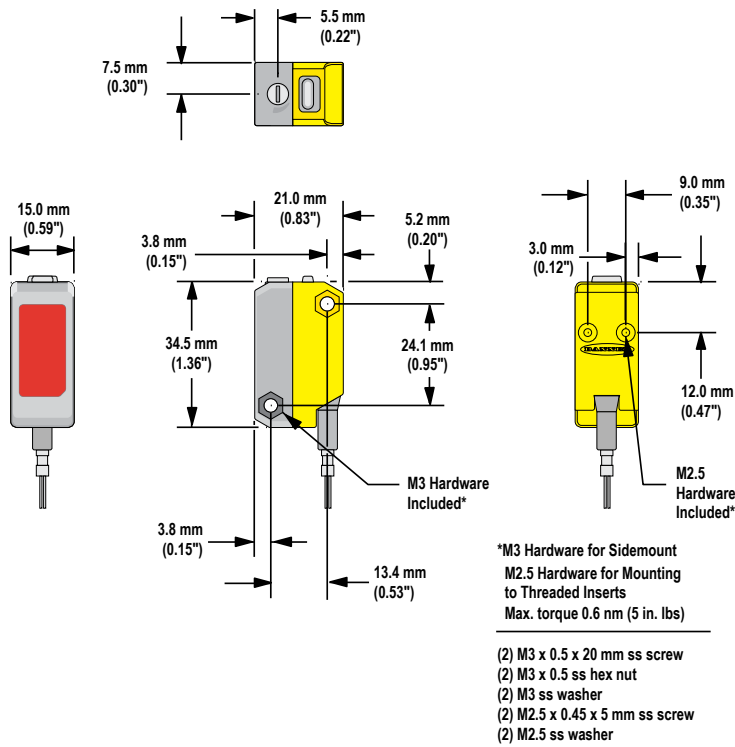

## Performance Curves

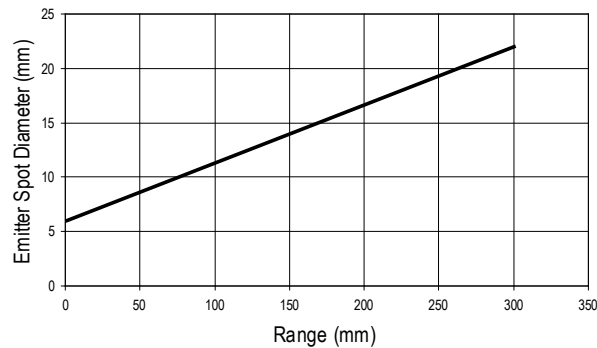
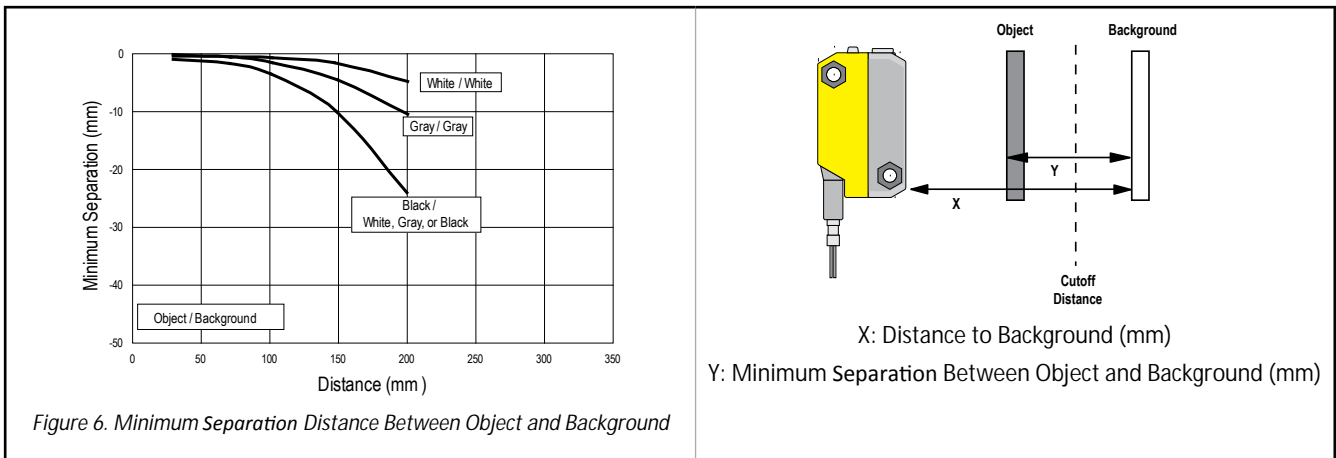
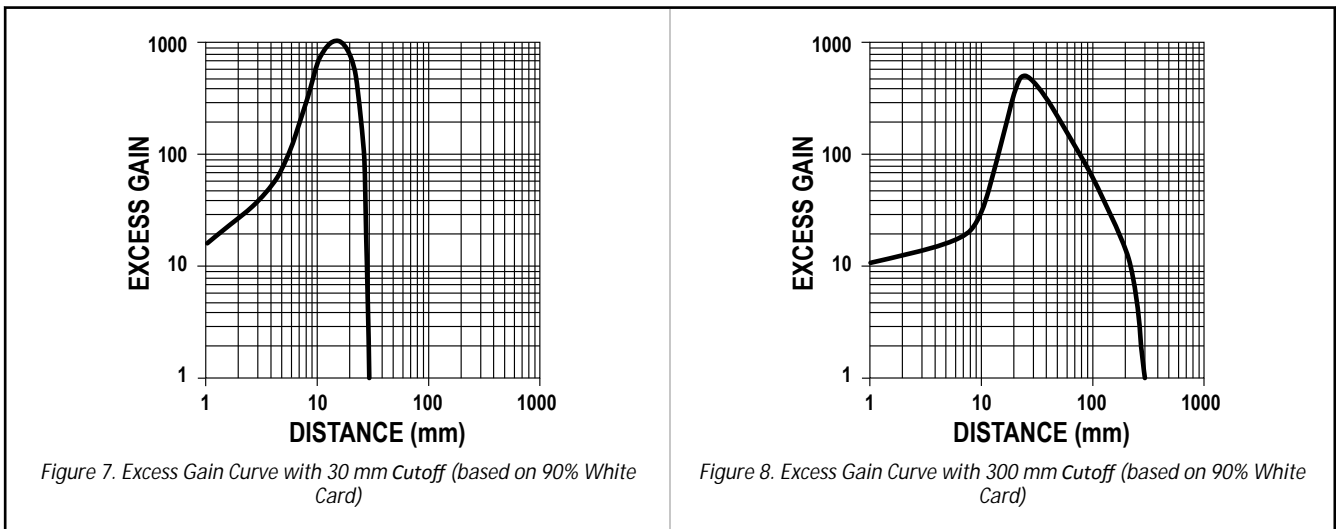

Figure 5. Typical Emitter Spot Diameter vs. Distance



### Excess Gain Curves



### Accessories

#### Quick-Disconnect (QD) Cordsets

4-Pin Snap-on M8/Pico-Style Cordsets				
Model	Length	Style	Dimensions	Pinout (Female)
PKG4-2	2 m (6.56 ft)	Straight		<p>1 = Brown 2 = White 3 = Blue 4 = Black</p>

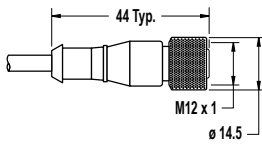
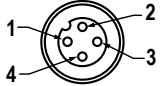
4-Pin Threaded M12/Euro-Style Cordsets				
Model	Length	Style	Dimensions	Pinout (Female)
MQDC-406	1.83 m (6 ft)	Straight		 <p>1 = Brown 2 = White 3 = Blue 4 = Black</p>
MQDC-415	4.57 m (15 ft)			
MQDC-430	9.14 m (30 ft)			
MQDC-450	15.2 m (50 ft)			

## Mounting Brackets

All measurements are listed in millimeters, unless noted otherwise.

### SMBQS18A

- Wrap-around protection bracket
- Die-cast bracket
- Base fits 18 mm threaded hole
- Metal hex nut, lock washer and grommet included
- Mounting holes specially designed for QS18AF sensors

Hole size: A = ø 15.3

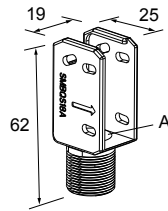

### SMBQS18AF

- Right-angle mounting bracket
- 14-ga. 304 stainless steel

Hole center spacing: A to B = 20.3

Hole size: A = 4.3 x 9.4, B = ø 4.3

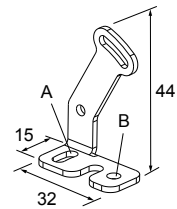

## Banner Engineering Corp. Limited Warranty

Banner Engineering Corp. warrants its products to be free from defects in material and workmanship for one year following the date of shipment. Banner Engineering Corp. will repair or replace, free of charge, any product of its manufacture which, at the time it is returned to the factory, is found to have been defective during the warranty period. This warranty does not cover damage or liability for misuse, abuse, or the improper application or installation of the Banner product.

THIS LIMITED WARRANTY IS EXCLUSIVE AND IN LIEU OF ALL OTHER WARRANTIES WHETHER EXPRESS OR IMPLIED (INCLUDING, WITHOUT LIMITATION, ANY WARRANTY OF MERCHANTABILITY OR FITNESS FOR A PARTICULAR PURPOSE), AND WHETHER ARISING UNDER COURSE OF PERFORMANCE, COURSE OF DEALING OR TRADE USAGE.

This Warranty is exclusive and limited to repair or, at the discretion of Banner Engineering Corp., replacement. IN NO EVENT SHALL BANNER ENGINEERING CORP. BE LIABLE TO BUYER OR ANY OTHER PERSON OR ENTITY FOR ANY EXTRA COSTS, EXPENSES, LOSSES, LOSS OF PROFITS, OR ANY INCIDENTAL, CONSEQUENTIAL OR SPECIAL DAMAGES RESULTING FROM ANY PRODUCT DEFECT OR FROM THE USE OR INABILITY TO USE THE PRODUCT, WHETHER ARISING IN CONTRACT OR WARRANTY, STATUTE, TORT, STRICT LIABILITY, NEGLIGENCE, OR OTHERWISE.

Banner Engineering Corp. reserves the right to change, modify or improve the design of the product without assuming any obligations or liabilities relating to any product previously manufactured by Banner Engineering Corp. Any misuse, abuse, or improper application or installation of this product or use of the product for personal protection applications when the product is identified as not intended for such purposes will void the product warranty. Any modifications to this product without prior express approval by Banner Engineering Corp will void the product warranties. All specifications published in this document are subject to change; Banner reserves the right to modify product specifications or update documentation at any time. Specifications and product information in English supersede that which is provided in any other language. For the most recent version of any documentation, refer to:

[www.bannerengineering.com](http://www.bannerengineering.com).