

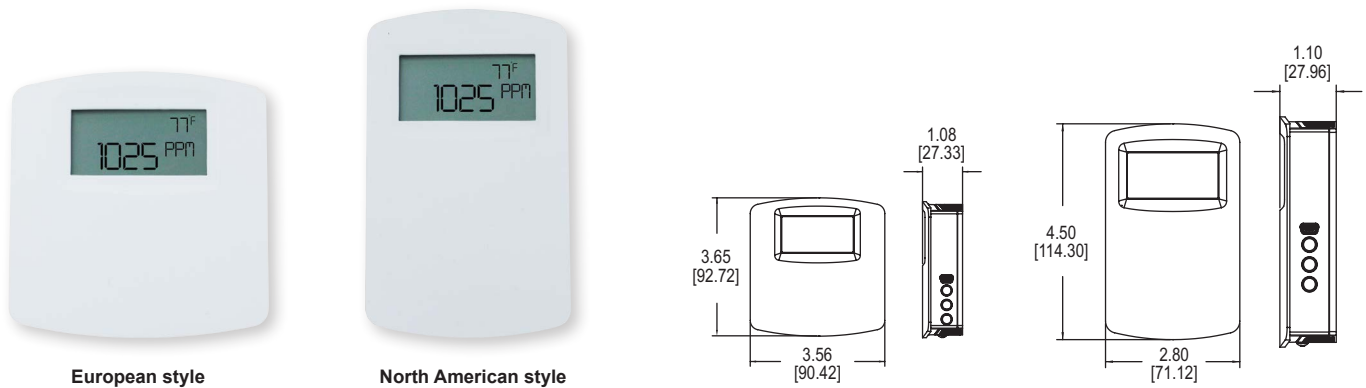

## Series CDTA Communicating Carbon Dioxide Detector

### Specifications - Installation and Operating Instructions



European style

North American style

The **Series CDTA Communicating Carbon Dioxide Detector** combines the function of three room sensors into a single, compact housing. Parameters include carbon dioxide, humidity, temperature, and temperature set point with override. By having field selectable Modbus® and BACnet Communications, only four wires are needed for power and the communication signal. The communicating detectors can be daisy-chained together to further reduce installation cost. In order to reduce the set up time, the RS-485 MAC address is set up using on board dip switches. A second set of dip switches are used to select whether output is Modbus® RTU or BACnet MS/TP communication protocols and to limit access to the set up menu.

Like our Series CDT Carbon Dioxide Transmitter, the Series CDTA uses a Single Beam Dual Wavelength Non-Dispersive Infrared (NDIR) sensor to measure the carbon dioxide level. This technology can be used in installations that will be occupied 24 hours per day. For improved accuracy, the transmitter can be field calibrated to the environmental conditions of the installation. Also, the barometric pressure can be programmed to correct for altitude. The humidity uses a capacitive polymer sensor and the temperature is measured using a 10KΩ thermistor sensor. The humidity sensor is field replaceable without the need for additional calibration.

Optional local and remote displays are available to display any of the parameters. For applications in which the building occupants aren't familiar with CO<sub>2</sub> concentrations, the LCD can be programmed to display temperature, humidity, or temperature set point instead.

#### Installation

**CAUTION** Disconnect power supply before installation to prevent electrical shock and equipment damage.

Make sure all connections are in accordance with the job wiring diagram and in accordance with national and local electrical codes. Use copper conductors only.

**NOTICE** Use electrostatic discharge precautions (e.g., use of wrist straps) during installation and wiring to prevent equipment damage.

**NOTICE** For optimal performance, self calibration feature of the transmitter requires exposure to normal outdoor equivalent carbon dioxide level once every thirty days.

**NOTICE** Avoid locations where severe shock or vibration, excessive moisture or corrosive fumes are present.

**NOTICE** Do not exceed ratings of this device, permanent damage not covered by warranty may result.

**NOTICE** Upon powering the transmitter, the firmware version will flash on the display. A warm up period of 30 minutes is required for the transmitter to adjust to the current CO<sub>2</sub> concentration.

#### SPECIFICATIONS

**Sensor (CO<sub>2</sub>):** Single-beam, dual-wavelength NDIR; Humidity: Capacitive polymer; Temperature: Solid state band gap.

**Range:** CO<sub>2</sub>: 0 to 2000 or 5000 PPM CO<sub>2</sub> (depending on model); Humidity: 0 to 100% RH; Temperature: 32 to 122°F (0 to 50°C).

**Accuracy:** CO<sub>2</sub>: ±40 PPM ±3% of reading; RH: ±2% (10 to 90% RH); Temperature: ±1°C @ 25°C.

**Temperature Dependence (CO<sub>2</sub>):** ±8 PPM / °C at 1100 PPM.

**Non-Linearity (CO<sub>2</sub>):** 16 PPM.

**Pressure Dependence (CO<sub>2</sub>):** 0.13% of reading per mm of Hg.

**Response Time (CO<sub>2</sub>):** 2 minutes for 99% step change.

**Temperature Limits:** 32 to 122°F (0 to 50°C).

**Humidity Limits:** 10 to 95% RH (non-condensing).

**Power Requirements:** 10-42 VDC / 10-30 VAC.

**Power Consumption:** Average: 0.5 watts; Peak: 1.2 watts.

**Output:** 2-wire RS-485, Modbus® RTU or BACnet MS/TP communication protocol.

**Weight:** 4.4 oz (125 g).

**Agency Approvals:** BTL, CE.

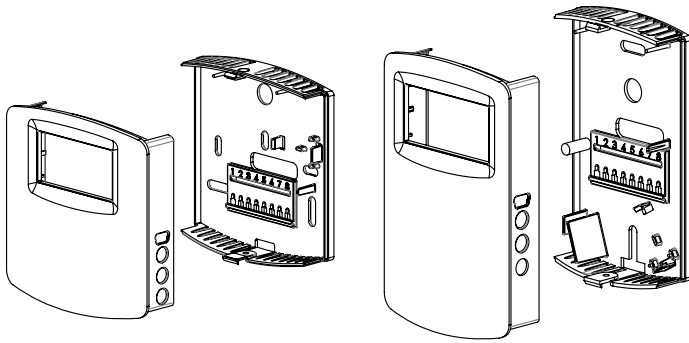

Figure 1: Removal of cover from back plate

**MOUNTING**

1. Push tab on top and bottom of cover and lift cover from back plate (See Figure 1).
2. Select the mounting location, away from diffusers, lights or any external influences.
3. Mount transmitter on a vertical surface to a standard electrical box using the two #6 M2C type screws provided.
4. Pull wires through sub base hole and make necessary connections.
5. Reattach cover to base plate.

**WIRING**

**NOTICE** Wiring should comply with Electrical Characteristics of Generators and Receivers for Use in Balanced Digital Multipoint Systems, TIA/EIA-485-A-1998, Telecommunications Industry Association, 1998.

BACnet installations should comply with ANSI/ASHRAE Standard 135-2010 BACnet A Data Communication Protocol for Building Automation and Control Networks, American Society of Heating, Refrigerating and Air-Conditioning Engineers, Inc., 2010.

Modbus® installations should comply with Modbus® Communication Protocol over Serial Line Specification and Implementation Guide V1.02, Modbus® Organization, Inc., 2006

Communications wiring must be in a daisy-chain fashion. Star connections are not permitted.

Cable shield must be connected to earth ground at one location only.

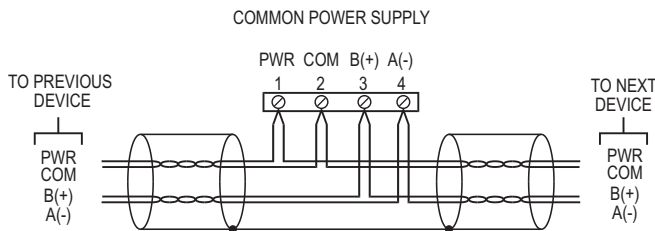

Figure 2

Figure 2 shows how to connect the CDTA in a network containing a common power supply. Use a cable containing two twisted pairs. One pair is to be used for B(+) and A(-). The other pair is to be used for power and common. This configuration is not suitable for AC supplies. Use a DC supply only. Care should be taken that there are not too many devices powered from the same supply as voltage drops will occur in the wiring. If you have many devices, or have long cable runs, the local supply configuration may be a better choice.

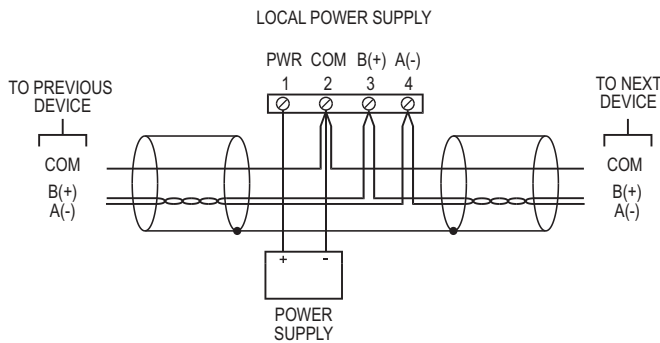

Figure 3

Figure 3 shows how to connect the CDTA in a network containing individual local supplies. Use a cable containing a twisted pair and a single conductor. The pair is to be used for B(+) and A(-). The single conductor is to be used for common. Both AC and DC supplies are suitable for this configuration.

In either configuration you must use shielded cable. Connect the shield to earth ground at one location only to prevent ground loops.

All devices in the network should be daisy chained. Star connections and T connections are not permitted.

The B(+) and A(-) lines must be terminated at both ends with a 120 ohm resistor. If the CDTA is an end device it has an on-board resistor that may be used. See DIP SWITCH SETTINGS to enable it.

**Dip Switch Configuration**

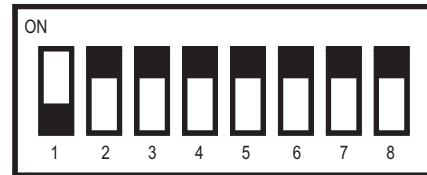

Figure 4: Dip switch SW2 (center-left)

Use DIP Switch SW2 (see Figure 4) to configure the RS-485 MAC address of the device. A valid address depends on the protocol selected. Valid BACnet addresses range from 0 to 127. Valid Modbus® addresses range from 1 to 247. By default, the device is shipped with BACnet selected and the address set to 127 (as shown in Figure 4). A valid and unused address should be set before connecting to an existing network. The device will not function properly if an invalid address is set. During the power up sequence, the LCD (if present) will display the RS-485 address as the primary value with "ADR" as the primary text and either "BAC" to indicate BACnet or "MOD" to indicate Modbus® as the secondary text. If the RS-485 MAC address is invalid, the invalid value is shown as the primary value with "ERR" as the primary text.

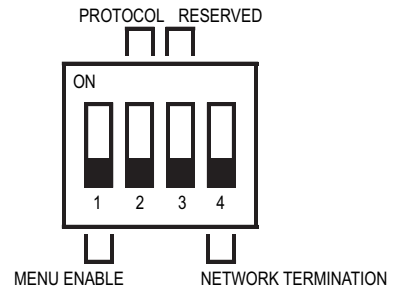
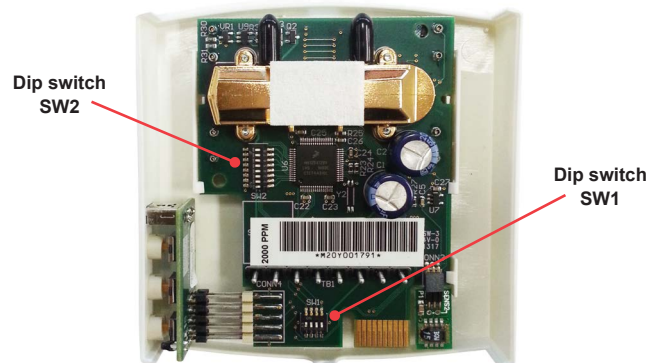

Figure 5: Dip switch SW1 (bottom-center)

Use DIP Switch SW1 (see Figure 5) to configure other hardware and software options.

Switch	ON	OFF
1 - Menu Enable	Access to the setup menu is enabled.	Access to the setup menu is disabled.
2 - Protocol	Modbus®	BACnet
3 - Reserved		
4 - Terminating Resistor	120 Ω Between A (-) and B (+)	Open



Internal view of transmitter  
Figure 6

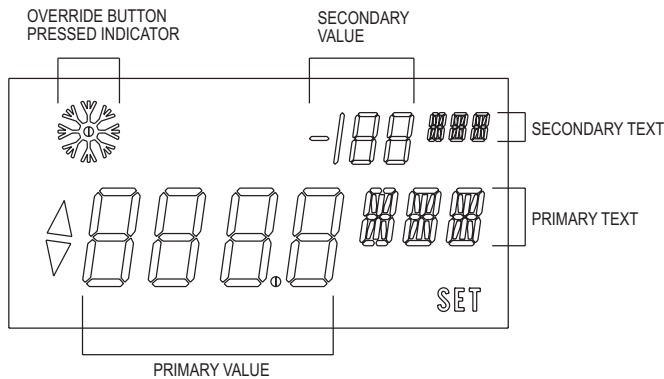

Figure 7: Display layout

### Home Screen Configuration (DSP)

This value controls what information is displayed on the home screen. See table below for possible values.

Setting Value	Primary Value	Primary Text	Secondary Value	Secondary Text
"CH"	CO2 Concentration	"PPM"	Relative Humidity	"%"
"CT"	CO2 Concentration	"PPM"	Temperature	"°C" or "°F"
"HT"	Relative Humidity	"%"	Temperature	"°C" or "°F"
"TS"	Temperature	"°C" or "°F"	Set Point	"°C" or "°F"
"S"	Set Point	"°C" or "°F"		
"T"	Temperature	"°C" or "°F"		
"H"	Relative Humidity	"%"		
"C"	CO2 Concentration	"PPM"		

### Units Selection (UNI)

This value controls the units that data is displayed in.

Setting Value	Description
"US"	US Customary Units (°F, in Hg)
"SI"	International System Units (°C, hPa)

### Set Point Low Limit Temperature (SOL)

This value sets a lower limit on the current set point value. The set point low limit value is numerical setting that supports continuous change (increment/decrement) by press and holding of either UP or DOWN button. If the new set point low limit temperature is higher than the current set point temperature, then the set point temperature will be set to the new set point low limit temperature.

Default Value	Minimum Value	Maximum Value	Increment
20°C (68°F)	0°C (32°F)	Set Point High Limit	1°

### Set Point High Limit Temperature (SOH)

This value sets an upper limit on the current set point value. The set point high limit value is numerical setting that supports continuous change (increment/decrement) by press and holding of either UP or DOWN button. If the new set point high limit temperature is lower than the current set point temperature, then the set point temperature will be set to the new set point high limit temperature.

Default Value	Minimum Value	Maximum Value	Increment
35°C (95°F)	Set Point Low Limit	50°C (122°F)	1°

### Typical Barometric Pressure (BAR)

This value sets the typical barometric pressure for the location where the device is mounted. The factory setting is for standard pressure at sea level. Adjusting the barometric pressure gives a more accurate measurement, especially at higher elevations.

Default Value	Minimum Value	Maximum Value	Increment
1013 hPa (29.9 in Hg)	677 hPa (20.0 in Hg)	1016 hPa (30.0 in Hg)	1 hPa (0.1 in Hg)

### CO2 Calibration Process (CAL)

This value initiates a calibration sequence of the carbon dioxide sensor to a known gas value. Read the calibration instructions before using this feature.

### Relative Humidity Offset (OFH)

This value allows the relative humidity to be adjusted by a fixed amount to match another calibrated measurement. The display shows the current relative humidity value plus any previous offset value.

Default Value	Minimum Value	Maximum Value	Increment
0%	-30%	30%	0.1%

### Temperature Offset (OFT)

This value allows the temperature to be adjusted by a fixed amount to match another calibrated measurement. The display shows the current temperature value plus any previous offset value.

Default Value	Minimum Value	Maximum Value	Increment
0%	-30%	30%	0.1%

### Home Screen

The home screen displays up to two parameters during normal operation. The parameters displayed on the home screen can be changed by the "DSP" setting in the setup menu.

### Set Point

When in the home display, a single press of either the UP or DOWN button will display the current temperature set point value. Additional presses of the UP or DOWN buttons will increase or decrease the set point by 1 degree per button depression. Holding the UP or DOWN button will continuously change the set point value until the button is released. The set point display will timeout and return to the home screen after 5 seconds of inactivity. At this point the new set point value is stored in non-volatile memory. The range of the set point value can be configured with "SOH" and "SOL" values in the setup menu. A display is not required to change the set point value.

### Override

When on the home screen or when changing the set point, the override button (middle button) can be pressed. When the override button is pressed, a snowflake symbol is displayed momentarily to indicate the button was pressed.

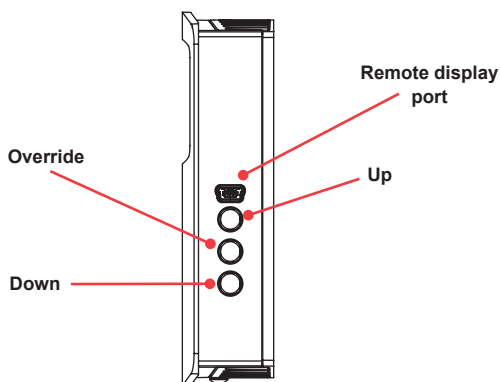

Side view of transmitter  
Figure 8

### Accessing Parameter Setup Menu

In order to access the parameter menu, press and hold the UP and DOWN buttons for 3 seconds. Once in the parameter menu, pressing the UP or DOWN buttons will cycle through the parameters. To change any of the parameters, press both the up and down arrow buttons simultaneously. The word SET will display in the lower right hand corner of the display. The UP or DOWN buttons can be used to change the value of the parameter. Press both the UP and DOWN buttons simultaneously to store the values. In order to go back to the home screen, press and hold the DOWN button for 3 seconds.

### CO<sub>2</sub> Offset (OFC)

This value allows the CO<sub>2</sub> Concentration to be adjusted by a fixed amount to match another calibrated measurement. The display shows the current CO<sub>2</sub> concentration value plus any previous offset value.

Default Value	Minimum Value	Maximum Value	Increment
0 PPM	-500 PPM	500 PPM	1 PPM

### Auto Serial Configuration (AUT)

This value enables or disables the automatic baud rate detection. If the device fails to communicate on the MS/TP bus or the serial configuration is not 8 data bits, no parity and 1 stop bit, then this value should be set to "OFF", and the serial configured manually.

Setting Value	Description
"ON"	Auto baud enabled, assumes 8 data bits, no parity and 1 stop bit
"OFF"	Auto baud disabled, serial baud rate, parity, and stop bits must be set manually

### Baud Rate (BAU)

This value provides the selection of the desired serial baud rate. This value is only visible when the value of AUT is "OFF".

Setting Value	Baud Rate (BPS)
9.6 K	9600
19.2 K	19,200
38.4 K	38,400
57.6 K	57,600
76.8 K	76,800
115.2 K	115,200

### Parity Selection (PAR)

This value provides the selection of the desired serial parity. This value is only visible when the value of AUT is "OFF".

Setting Value	Description
"NON"	No Parity
"EVE"	Even Parity
"ODD"	Odd Parity

### Stop Bits Selection (STP)

This value provides the selection of the desired serial stop bits. This value is only visible when the value of AUT is "OFF".

Setting Value	Description
1	One Stop Bit
2	Two Stop Bits

### Reset To Factory Defaults (RST)

This value, when set to "YES", will reset all user settings to their default values and reset the device. This applies to all settings including BACnet writable settings.

### Calibrating Sensor

- Step 1: Remove the cover as shown in Figure 1.
- Step 2: Remove one of the gas nipple covers on the CO<sub>2</sub> sensor and attach tubing from the gas pressure regulator to the nipple (See Figure 5).
- Step 3: Attach the terminal block accessory to the circuit board so that the power wires line up with terminals 1 and 2. Plug in the power supply to power up the transmitter.
- Step 4: Hold housing so that the sensor is in the vertical plane as shown in Figure 5.
- Step 5: Follow the steps in the accessing parameter section to access the calibration parameter (CAL).
- Step 6: Press and hold the Up and Down arrows for 3 seconds.
- Step 7: Flow zero reference gas at 0.3 SLPM for 5 minutes.
- Step 8: Press and hold the Down button for 0.5 seconds.
- Step 9: Flow the full scale reference gas at 0.3 SLPM for 5 minutes.
- Step 10: Press and hold the Up button for 0.5 seconds.
- Step 11: Exit the parameter menu.
- Step 12: Disconnect the power supply from the power source and remove the terminal block from the circuit board.
- Step 13: Remove tubing from sensor and re-attach the gas nipple cover to the sensor.
- Step 14: Re-attach the cover to the back plate.

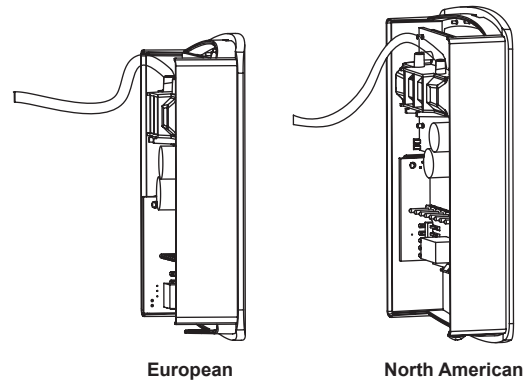

Figure 9: Calibration

### MAINTENANCE/REPAIR

Upon final installation of the Series CDTA, no routine maintenance is required. The Series CDTA is not field serviceable and should be returned if repair is needed. Field repair should not be attempted and may void warranty.



This symbol indicates waste electrical products should not be disposed of with household waste. Please recycle where facilities exist. Check with your Local Authority or retailer for recycling advice.

### WARRANTY/RETURN

Refer to "Terms and Conditions of Sale" in our catalog and on our website. Contact customer service to receive a Return Goods Authorization number before shipping the product back for repair. Be sure to include a brief description of the problem plus any additional application notes.

Modbus® is a registered trademark of Schneider Automation, Inc.